

Living up to Life

*Leica*  
MICROSYSTEMS

# Leica DM100 & Leica DM300

Affordable Innovation for the First-time Scientist



# Affordable Innovation for the Next Generation of Scientists

Students learn best when their equipment is easy to use and constructed to be robust enough for trouble free operation each day.

Leica Microsystems, with 165 years of microscope design and manufacturing experience, combines the latest technology in optics, mechanics, and illumination in the new Leica DM100 and DM300 student microscopes. These microscopes provide students with the capabilities they need to study the finest details in all the life sciences.

## Construction that lasts

- › Focus drive design has been proven in the clinical laboratory

## Brilliant illumination

- › Leica EZLite™ LED illumination produces crisp, clear images

## View the finest details

- › Outstanding optical quality reveals the finest specimen details



Convallaris – Lily of the Valley

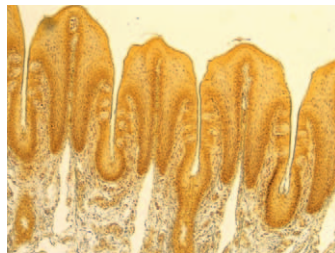

Taste Buds

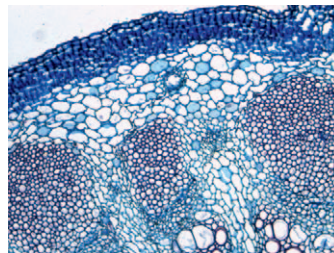

Sunflower



Giant Chromosomes

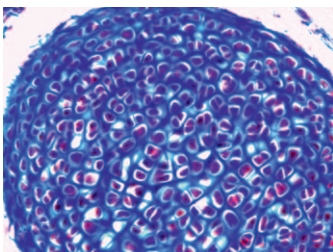

Mouse Embryo

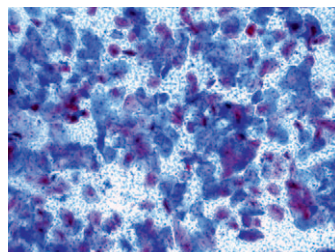

Squamos Epithelium

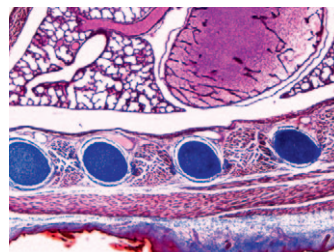

Mouse Embryo

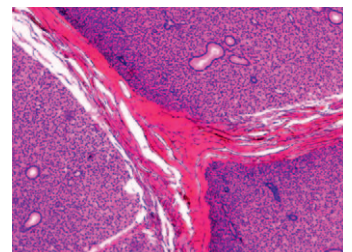

Parotid Gland



# Benefits: Leica DM100 & DM300

## Robust construction:

- › Maintenance-free, sealed, brass shaft, focus mechanism; the same design that is used in Leica Microsystems' clinical microscopes provides accurate focus control over the life of the microscope
- › Spring-loaded, high-magnification objectives prevent broken specimen slides
- › Designed to International Safety Standards

## Optimized Illumination and Optics:

- › LED illumination saves the cost of replacement lamps and provides a cool white light for over 20 years of average use at 80% lower energy consumption
- › Leica EZLite™ illumination system provides an evenly illuminated field of view for accurate specimen viewing
- › The illumination system provides stable, true daylight quality with a wide brightness ratio of 200 to 1

- › Superb optical performance as a result of the illumination, objective, viewing tube, and eyepiece working seamlessly together

## Student Friendly:

- › Coaxial focus mechanism for intuitive control
- › Compact size with small footprint for easy storage and carrying
- › Continuous light intensity control for comfortable viewing with specimens of various thickness and color
- › Leica EZTube™ binocular and monocular tubes with integrated eyepieces prevent loss
- › Provides continuous 360° tube rotation for shared viewing and easy storage

## Flexibility:

- › Pre-configured outfits for easy ordering
- › Choice of monocular or binocular tube depending on budget

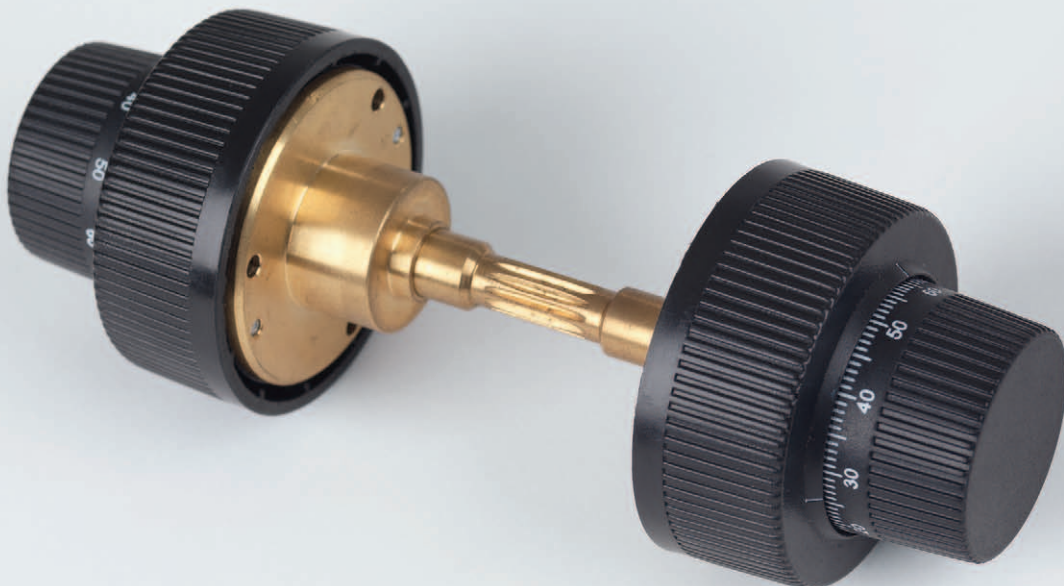

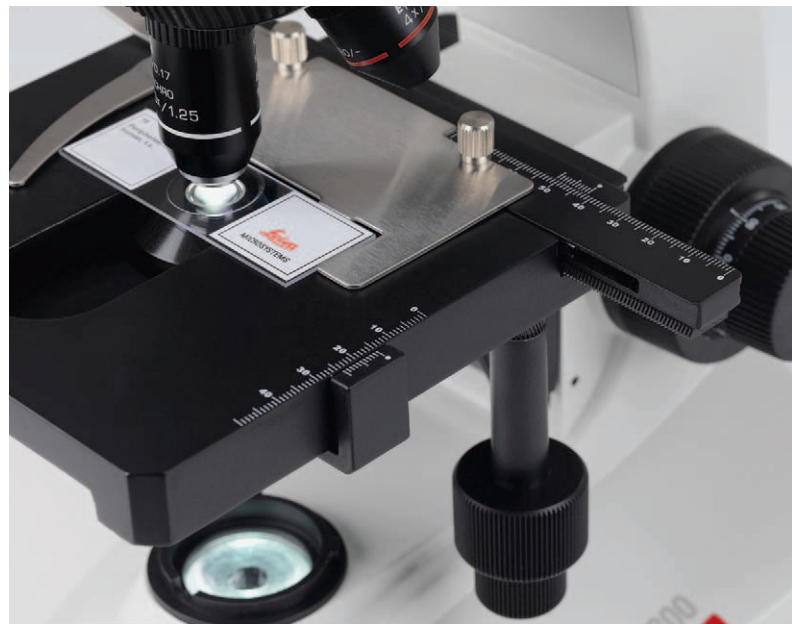
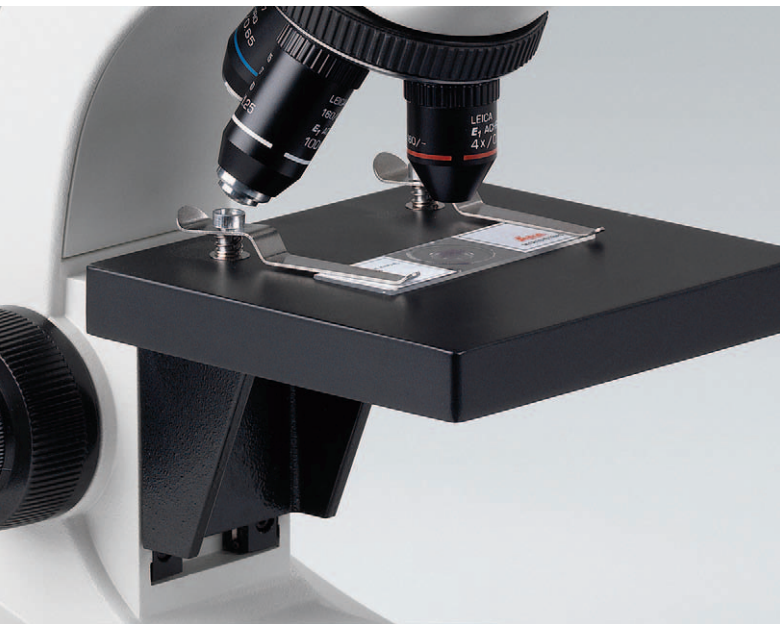
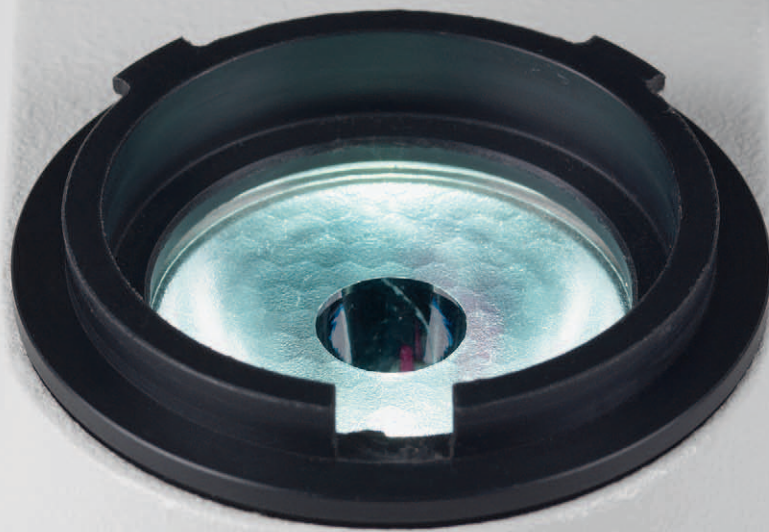

### Leica DM100

---

- › Affordable entry-level microscope
- › Fixed stage with stage clips for accurate manual specimen manipulation
- › Pre-centered, pre-focused condenser lens built into the stage for student-friendly operation
- › Clearly labeled disc diaphragm for matching aperture with objective for maximum resolution
- › Commonly configured with monocular tube for economy

### Leica DM300

---

- › Second level microscope for full lab sessions
- › Built-in mechanical stage with low position X/Y controls for accurate specimen movement at high magnifications
- › Pre-centered, pre-focused professional condenser system for maximizing illumination
- › Clearly labeled adjustable iris diaphragm for fine tuning the image resolution
- › Commonly configured with binocular tube for comfortable viewing during longer lab sessions

# Outfit Matrix

<b>ATTENTION:</b> <b>POWER CORD MUST BE ORDERED SEPARATELY</b>		13 613 301 Leica DM100 LED, Monoc, Fixed Stage, Disc Diaphragm, E1 4×, 10×, 40×, Dust Cover, User Documents	13 613 302 Leica DM300 LED, Monoc, Mechanical Stage, Abbe Condenser, E1 4×, 10×, 40×, Dust Cover, User Documents	13 613 303 Leica DM300 LED, Monoc, Mechanical Stage, Abbe Condenser, E1 4×, 10×, 40×, 100×, oil, Dust Cover, User Documents	13 613 304 Leica DM300 LED, Binoc, Mechanical Stage, Abbe Condenser, E1 4×, 10×, 40×, 100×, oil, Dust Cover, User Documents	13 613 305 Leica DM300 LED, Binoc, Mechanical Stage, Abbe Condenser, E2 Plan 4×, 10×, 40×, 100×, oil, Dust Cover, User Documents
<b>Stands</b>						
13 613 310	Leica DM100 Stand, Fixed Stage, Disc Diaphragm, Dust Cover, User Documents	X				
13 613 311	Leica DM300 Stand, Mechanical Stage, Abbe Condenser, Dust Cover, User Documents		X	X	X	X
<b>Tubes</b>						
13 613 320	Monocular Leica EZTube™ with eyeguard and pointer	X	X	X		
13 613 322	Binocular Leica EZTube™ with eyeguards, with pointer in right eyepiece				X	X
<b>E1 Objectives</b>						
13 394 000	Achromat 4×/0.10	X	X	X	X	
13 394 005	Achromat 10×/0.25	X	X	X	X	
13 394 010	Achromat 40×/0.65	X	X	X	X	
13 394 015	Achromat 100×/1.25 oil			X	X	
<b>E2 Plan Objectives</b>						
13 494 020	Plan Achromat 4×/0.10					X
13 494 025	Plan Achromat 10×/0.25					X
13 494 030	Plan Achromat 40×/0.65					X
13 494 035	Plan Achromat 100×/1.25 oil					X
<b>Accessories</b>						
13 614 800	Immersion oil, 10 ml			X	X	X

# Dimensions

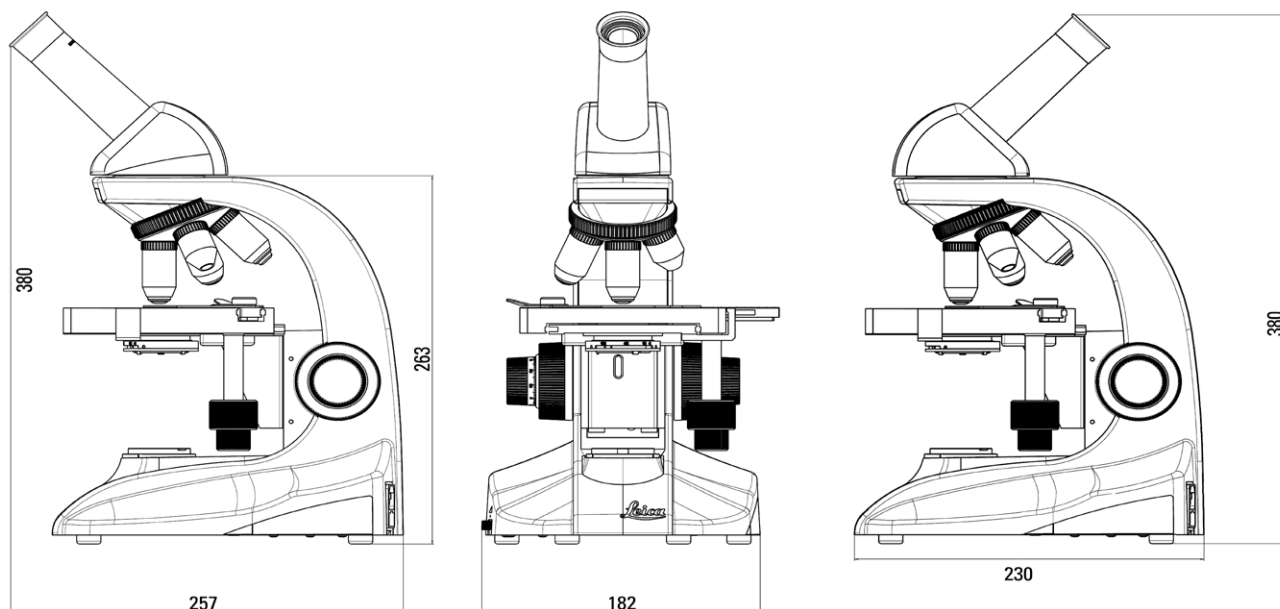

# System Diagram

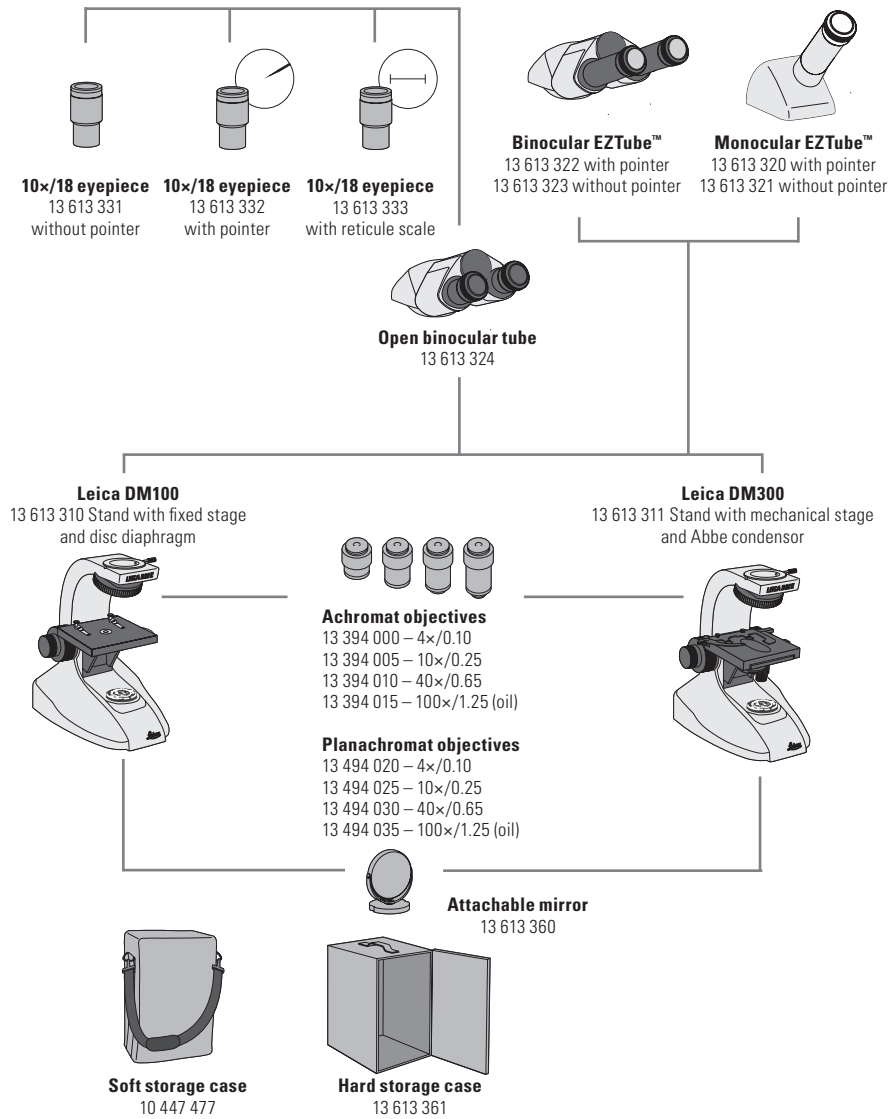

## BASIC COMPONENTS

- 13 613 331 10x/18 eyepiece without pointer
- 13 613 332 10x/18 eyepiece with pointer
- 13 613 333 10x/18 eyepiece with reticule scale

- 13 613 320 Monocular EZTube™ with pointer
- 13 613 321 Monocular EZTube™ without pointer
- 13 613 322 Binocular EZTube™ with pointer
- 13 613 323 Binocular EZTube™ without pointer
- 13 613 324 Open binocular tube

- 13 613 310 Leica DM100 Stand with fixed stage and disc diaphragm
- 13 613 311 Leica DM300 Stand with mechanical xy-stage and Abbe condenser

- 13 394 000 Objective Achromat 4x/0.10 NA
- 13 394 005 Objective Achromat 10x/0.25 NA
- 13 394 010 Objective Achromat 40x/0.65 NA
- 13 394 015 Objective Achromat 100x/1.25 (oil)

- 13 494 020 Objective Planachromat 4x/0.10
- 13 494 025 Objective Planachromat 10x/0.25
- 13 494 030 Objective Planachromat 40x/0.65
- 13 494 035 Objective Planachromat 100x/1.25 (oil)



## OPTIONS

- 10 447 477 Soft storage case
- 13 613 361 Hard storage case
- 13 614 800 Immersion oil 10 ml
- 13 613 363 Simple polarization kit
- 13 613 360 Attachable mirror

## REPLACEMENTS

- 13 613 300-100 User Document
- 13 596 010 Dust cover
- 13 613 362 Pair of eyeguards
- 13RFAG30003 Replacement Fuse

## INTERNATIONAL POWER CORDS

- 13 613 900 U.S. 
- 13 613 901 Europe Continental 
- 13 613 902 U.K. 
- 13 613 903 Switzerland 
- 13 613 904 Denmark 
- 13 613 905 Italy 
- 13 613 906 Australia 
- 13 613 907 China 
- 13 613 908 Japan 
- 13 613 909 Israel 
- 13 613 910 South Africa 
- 13 613 911 India 
- 13 613 912 Argentina 

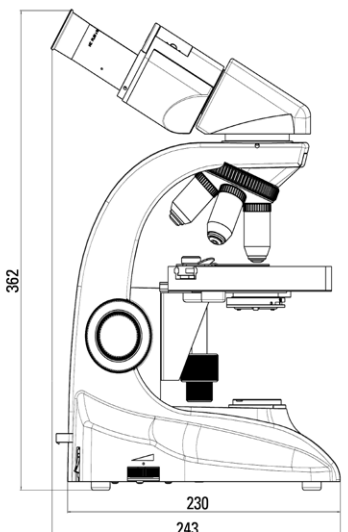
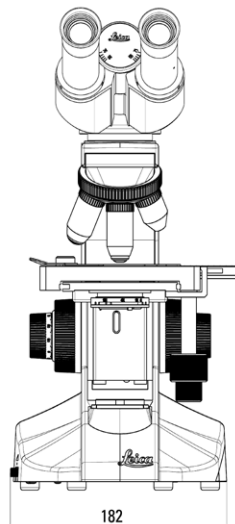
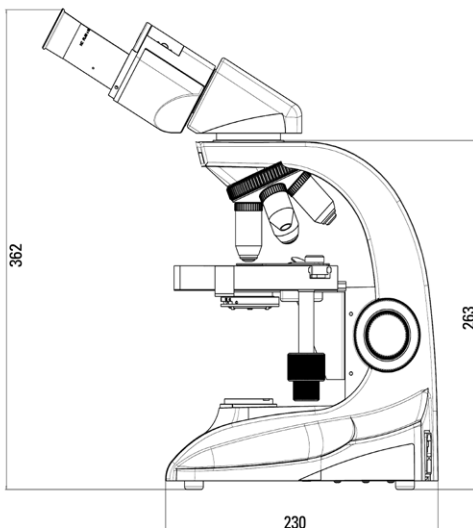

# Specifications Leica DM100 & DM300

## SEPARATE EYEPIECES

---

- › High eyepoint
- › 10×/18 eyepieces fixed
- › Available with or without pointer and with a measuring reticule
- › Foldable eyeguards
- › 23.2 mm mounting diameter

## EZTUBE™ MONOCULAR TUBE

---

- › 45 degree viewing angle
- › 10×/18 eyepiece integrated into eyetube
- › Attached to stand with 2 set screws
- › Rotatable mounting
- › Available with and without pointer

## STAND

---

- › Stand shape protects controls
- › Stand construction – die-cast aluminium
- › External fuses
- › Knurled nosepiece control
- › 4 position nosepiece
- › Drop in holder for 32 mm mounted or not mounted filters

## EZTUBE™ BINOCULAR TUBE

---

- › Preset diopters for corrected vision
- › 30° viewing angle
- › 10×/18 high eyepoint eyepieces integrated into eyetubes
- › Attached to stand with 2 set screws
- › Rotatable mounting
- › Available with and without pointer
- › Interpupillary distance range 52 mm – 75 mm

## OPEN BINOCULAR TUBE

---

- › Accepts separate 10×/18 eyepieces
- › Left eyetube with diopter focus
- › 30° viewing angle
- › Attached to stand with 2 set screws
- › Rotatable mounting
- › Interpupillary distance range 52 mm – 75 mm

## EZLITE™ ILLUMINATION

---

- › Preset field aperture
- › LED illumination – 6000 K temp, 25,000 h life at full intensity
- › Continuous intensity adjustment
- › Illumination enough for viewing at lowest intensity
- › Simple polarizing kit available

## CONDENSER

---

- › Prefocused and precentered condenser
- › Leica DM100 – NA = 0.65 – Disc diaphragm with magnification indicators
- › Leica DM300 – NA = 0.9/1.25 oil – Adjustable diaphragm with magnification labels

## STAGE

---

- › Leica DM100 – Fixed – Size: 13.0 cm (X) × 12.4 cm (Y)
- › Leica DM300 – Mechanical Right handed
- › Size: 13.5 cm (X) × 13.5 cm (Y)
- › Travel: 7.8 cm (X) × 3.6 cm (Y)
- › Front loading specimen holder for one standard slide

## FOCUS

---

- › Coaxial focus controls
- › Self-adjusting focus mechanism
- › 300 microns per fine focus rotation
- › Calibrated in 3 micron increments

## CERTIFICATIONS

---

- › cULus, CE, RoHS

## SHIPPING

---

- › Dimensions: 45 cm × 31.5 cm × 42 cm
- › Weight: 6.5 kg