

OPERATION MANUAL

AC Withstanding Voltage Tester

TOS8040

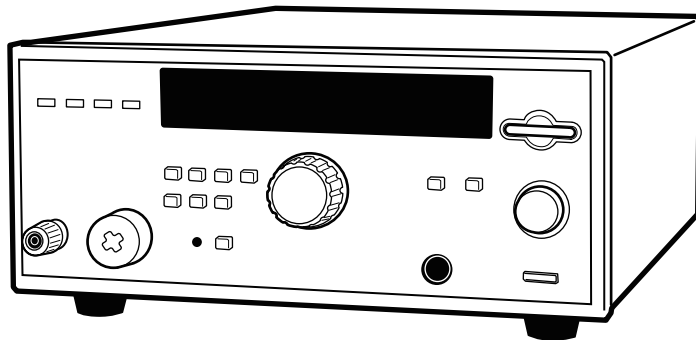

DANGER

This instrument generates high voltage.

- Any incorrect handling may cause death.
- Read “Precautions for Safe Testing” in this manual to prevent accident.
- Keep this manual near the instrument for easy access of the operator.

Use of Operation Manual

Please read through and understand this Operation Manual before operating the product. After reading, always keep the manual nearby so that you may refer to it as needed. When moving the product to another location, be sure to bring the manual as well.

If you find any incorrectly arranged or missing pages in this manual, they will be replaced. If the manual gets lost or soiled, a new copy can be provided for a fee. In either case, please contact Kikusui distributor/agent, and provide the “Kikusui Part No.” given on the cover.

This manual has been prepared with the utmost care; however, if you have any questions, or note any errors or omissions, please contact Kikusui distributor/agent.

Reproduction and reprinting of this operation manual, whole or partially, without our permission is prohibited.

Both unit specifications and manual contents are subject to change without notice.

Testing Cannot be Performed at Unpacking

If the TOS8040's power is turned on in the condition in which the tester has been simply unpacked upon receipt, the interlock function will be activated, preventing performance of testing as-is. See "6.2 Using the INTERLOCK Terminal" (page 45) to operate the tester, taking advantage of the interlock function.

■ About this manual

This documentation is the Operation Manual for the TOS8040 AC Withstanding Voltage Tester.

Firmware version of the product to be used:

This Operation Manual applies to products incorporating firmware of:

Version 1.0x

The firmware version is indicated on the test time indicator when the POWER switch is turned on. For more information, see "5.1 Turning the POWER Switch On" (page 32).

When inquiring about the product, please provide this version number and the serial number indicated on the rear of the product.

To the Supervisor in Charge of Operation

- If the operator does not read the language used in this manual, translate the manual into the appropriate language.
- Help the operator in understanding this manual before operation.
- Keep this manual near the instrument for easy access by the operator.

Hazardous Operations

Any of the following operations will result in electric shock, which may lead to serious injury or death.









- Touching the output terminal while output is being generated.
- Touching a test lead connected to the output terminal while output is being generated.
- Touching the DUT while output is being generated.
- Touching a part electrically connected to the output terminal while output is being generated.

Any of the following actions may result in electric shock leading to serious injury or death.

- Operating the tester without connecting the grounding wire to ground.
- Operating the tester without wearing rubber gloves intended for electrical work.
- Approaching a section electrically connected to the output terminal while output is being generated.

Safety Symbols

For the safe use and safe maintenance of this product, the following symbols are used throughout this manual and on the product. Understand the meanings of the symbols and observe the instructions they indicate (the choice of symbols used depends on the products).

	Indicates that a high voltage (over 1 000 V) is used here. Touching the part causes a possibly fatal electric shock. If physical contact is required by your work, start work only after you make sure that no voltage is output here.
DANGER	Indicates an imminently hazardous situation which, if ignored, will result in death or serious injury.
 WARNING	Indicates a potentially hazardous situation which, if ignored, could result in death or serious injury.
 CAUTION	Indicates a potentially hazardous situation which, if ignored, may result in damage to the product and other property.
	Shows that the act indicated is prohibited.
	Is placed before the sign “DANGER,” “WARNING,” or “CAUTION” to emphasize these. When this symbol is marked on the product, see the relevant sections in this manual.
	Protective conductor terminal.
	Chassis (frame) terminal.
	On (supply)
○	Off (supply)
	In position of a bi-stable push control
	Out position of a bi-stable push control

Safety Precautions

The following safety precautions are intended to avoid fire hazard, electrical shock, and other accidents or failures. Use of the product in a method not specified in this manual may impair the effectiveness of built-in protective functions.



Users

- This product must be used only by qualified personnel who understand the contents of this Operation Manual.
- If this product is handled by unqualified personnel, personal injury may result. Ensure that the product is handled under the supervision of qualified personnel (i.e., those experienced in electrical applications).

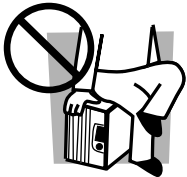

Purposes of use

- Do not use the product for any purpose other than those specified.
- This product is not designed or manufactured for home use or for general consumers.

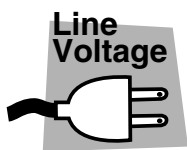

Input power

- Always connect the product to a power supply in line with the product's input rating.
- Use the provided power cord to supply input power.
- This product is designed as equipment falling under Overvoltage Category II of the IEC Standards (energy-consuming equipment to be supplied from fixed installation).

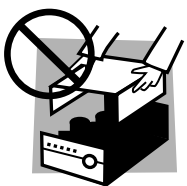

Cover

- Components inside the instrument may present physical hazards. Do not remove the external cover.

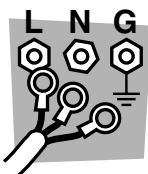

Grounding

- The product is equipment falling under Safety Class I of the IEC Standards (equipment with a protective conductor terminal). Always ground the product's protective conductor terminal to prevent electric shock.

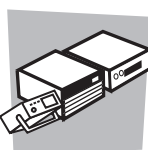

Installation

- This product is designed for indoor use. Only use it indoors.
- When installing products be sure to observe "2.2 Precautions for Installation" described in this manual.

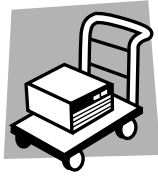

Relocation

- Turn off the POWER switch and disconnect all cables before relocating the product.
- Be sure the operation manual be included when the product is relocated.



Operation

- Before using the tester, check that there are no abnormalities on the surface of the power cord. (Before doing this, always disconnect the power cord from the electrical outlet.)
- If any abnormality or failure is detected in the products, stop using it immediately. Unplug the power cord. Be careful not to allow the product to be used before it is completely repaired.
- Do not disassemble or modify the product. If it must be modified, contact Kikusui distributor/agent.



Maintenance and checking

- To avoid electrical shock, be absolutely sure to unplug the power cord before performing maintenance or checking.
- Do not remove the cover when performing maintenance or checking.
- To maintain performance and safe operation of the product, it is recommended that periodic maintenance, checking, cleaning, and calibration be performed.



Service

- Internal service is to be done by Kikusui service engineers. If the product must be adjusted or repaired, contact Kikusui distributor/agent.

Label

- The product carries a label providing important safety information. If this label is damaged or the information provided becomes illegible, replace it with a new label. To obtain a new label, please contact your Kikusui distributor or agent.



危険 高电压
DANGER High Voltage
危険 高电压



本仪器输出过程中，为了防止触电事故的发生，请严格遵守以下操作规程。
(1) 不要触摸输出端子。
(2) 不要触摸连接输出端的测试线。
(3) 不要触摸被测体。
(4) 输出切断后，请不要立刻触摸以上部分。
如果不遵守上述注意事项，有可能发生重大的人身事故。
在使用之前，请仔细阅读使用说明书。

While tester is generating output:
(1) **Do not touch** output terminal.
(2) **Do not touch** lead-wire connected with output terminal.
(3) **Do not touch** device under test.
(4) **Do not touch** such parts immediately after output is cut off.
Failure to do so could result in **serious injury or death**.
Read OPERATION MANUAL before operating.

本器が出力中は、感電事故防止のため次の事をお守り下さい。
(1) 出力端子に触らない。
(2) 出力端子に接続されているリード線に触らない。
(3) 被試験物に触らない。
(4) 出力遮断後すぐに、(1)～(3)の部分に触らない。
上記事項を守らない場合、人命にもかかわる重大な事故となることがあります。
ご使用になる前に、取扱説明書をお読み下さい。

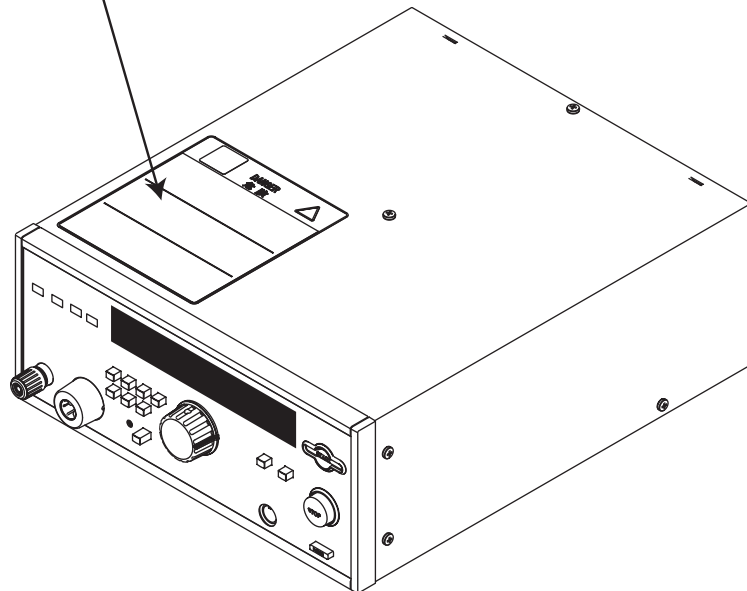

Front and rear panels

- Before using the tester, make sure you read and understand Chapter 3, “Precautions for Safe Testing.”

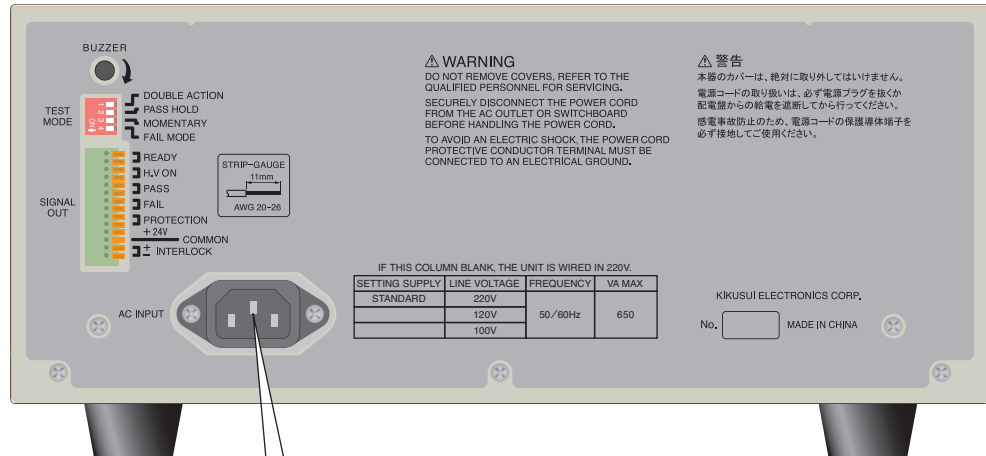
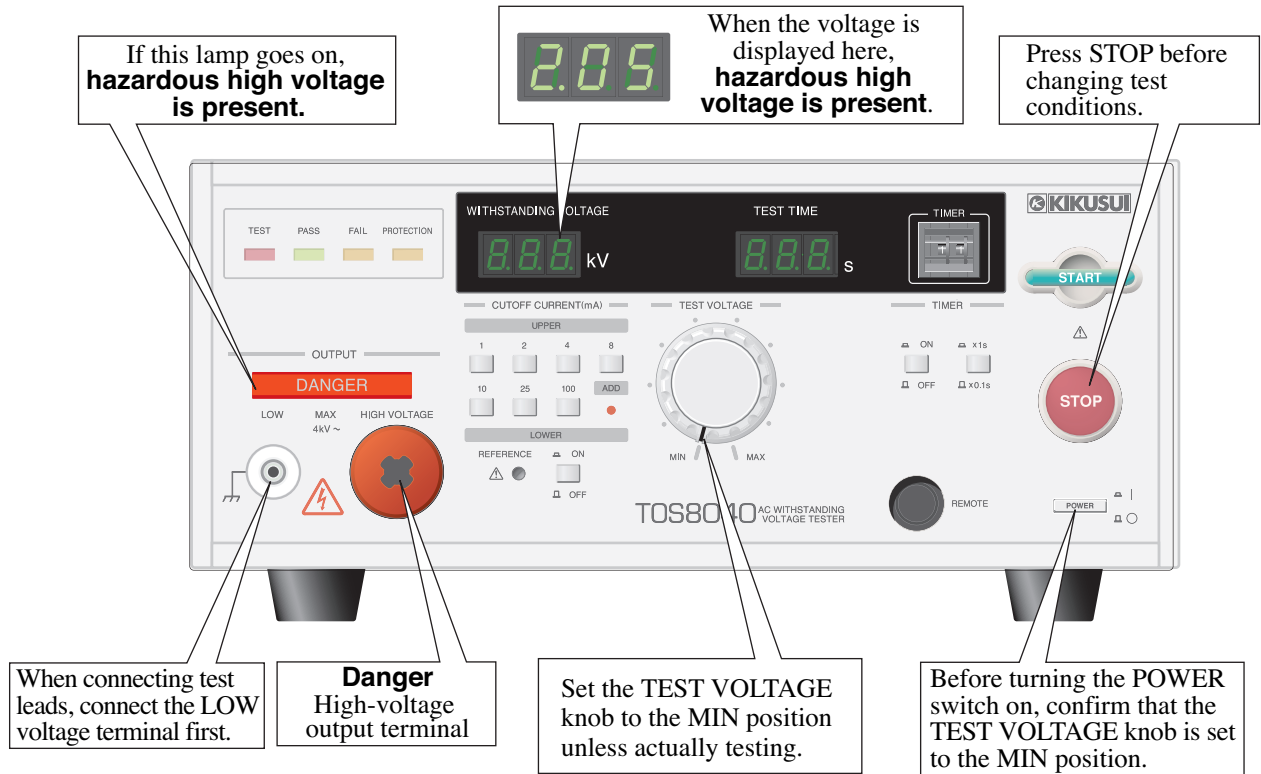

Organization of the Operation Manual

The information in this manual is organized into the following chapters:

Chapter 1 General

Provides a product overview and describes features and options.

Chapter 2 Installation and Preparations for Use

Describes how to unpack the tester for preparation before use.

Chapter 3 Precautions for Safe Testing

Gives the precautions to be observed at all times to ensure safe testing.

Chapter 4 Part Name's and Functions

Gives the names of switches, terminals, and other controls of the TOS8040.

Chapter 5 Panel Operations

Describes procedures for testing.

Chapter 6 Remote Control

Gives the procedure for operating the tester from a remote location using the REMOTE connector and the INTERLOCK terminal.

Chapter 7 Status Signal Output

Describes the status signal outputs (SIGNAL OUT).

Chapter 8 Special Test Modes

Explains the special test modes.

Chapter 9 Maintenance and Calibration

Describes the maintenance and calibration of the tester. The tester must be periodically inspected, maintained, and calibrated to maintain performance.

Chapter 10 Specifications

Provides the electrical and mechanical specifications for the TOS8040.

Appendix

Provides guidelines for current detection lower reference limit and zero-start switch.

Contents

Testing Cannot be Performed at Unpacking	1
To the Supervisor in Charge of Operation	2
Hazardous Operations	2
Safety Symbols	3
Safety Precautions	4

Chapter 1 General

1.1 Product Overview	12
1.2 Features	12
1.3 Options	14

Chapter 2 Installation and Preparations for Use

2.1 Unpacking Inspection	16
2.2 Precautions for Installation	17
2.3 Moving Precautions	18
2.4 Connecting the Power Cord	18
2.5 Grounding	20

Chapter 3 Precautions for Safe Testing

3.1 Startup Inspection	21
3.2 Preparations Before Testing	21
3.2.1 Checking the Test Leads	21
3.2.2 Wearing Rubber Gloves	21
3.3 Operating Precautions	22
3.3.1 Connecting the Test Leads	22
3.3.2 For High Voltage Output	24
3.3.3 Checking Safety after Shutting off the Output	25
3.4 When Interrupting Operations	26
3.5 Response to Emergencies	26
3.6 Stop Using the Tester in the Event of a Malfunction	27

Chapter 4 Part Name's and Functions

4.1 Front Panel	28
4.2 Rear Panel	31

Chapter 5 Panel Operations

5.1 Turning the POWER Switch On	32
5.2 Tester States and Indications	33

5.2.1	Five States	34
5.2.2	Events or Conditions That Can Activate the Protection Function	35
5.3	Procedure for Test	36
5.3.1	Test Parameters	36
5.3.2	Connection to the DUT	40
5.3.3	Starting the Test and Making Judgments	40

Chapter 6 Remote Control

6.1	Using the REMOTE Connector	41
6.1.1	Remote Control with the Optional Remote Control Box	41
6.1.2	Remote Control Using a Control Device	42
6.2	Using the INTERLOCK Terminal	45

Chapter 7 Status Signal Output

7.1	Five Signal Outputs	46
7.2	Using the SIGNAL OUT Terminals	47
7.2.1	Description of the Terminals	47
7.2.2	Example: Use of Signals	48

Chapter 8 Special Test Modes

8.1	Four Test Modes	49
8.1.1	DOUBLE ACTION	49
8.1.2	PASS HOLD	50
8.1.3	MOMENTARY	50
8.1.4	FAIL MODE	51

Chapter 9 Maintenance and Calibration

9.1	Cleaning the Tester	52
9.2	Inspection	52
9.3	Calibration	52

Chapter 10 Specifications

10.1	Basic Specifications	53
10.2	Other Functions	55
10.3	General Specifications	55
10.4	Dimensions	56

Appendix

A.1	Setting the Current Detection Lower Reference Limit	57
A.2	Improvements in Waveform Obtained Using a Zero-start Switch	59

Index	60
-------	----

Provides a product overview and describes features and options.

1.1 Product Overview

This instrument is a withstanding voltage tester with a maximum output of 4 kV/100 mA. It is capable of performing withstanding voltage (dielectric strength) tests for any electronic device or component according with JIS, UL, CSA, BS, or other various standards.

-
- ⚠ WARNING** • Note to the supervisor in charge of operation, and operator
- The utmost care has been devoted to making this tester as safe as possible. However, accidental contact with the device under testing (DUT), test lead, test probe, or the periphery of the output terminals may result in electric shock, since high voltage is applied to the DUT during tester operations. Thus, use of the tester requires thorough safety measures, including provision of fences at the peripheries of the tester and DUT to prevent personnel from approaching without good reason and to maintain safety.
-

1.2 Features

■ AC withstanding voltage tests of up to 4 kV/100 mA

The TOS8040 has a 500 VA high-voltage transformer in the high-voltage power supply section for tests involving a maximum output of 4 kV/100 mA (for 10 minutes maximum). For test voltages of 1 kV or higher, the tester can perform tests that meet the requirements (short-circuit current of 200 mA or more *) of the IEC standards.

* Continuous output is not available, since the output shuts off when an overcurrent is detected.

■ Test time of 0.5 s to 99 s (x0.1 / x1 range)

The test time can be set to a duration in the range from 0.5 s to 99 s, and in 0.1 s intervals in the range from 0.5 s to 9.9 s (x0.1 range).

■ PASS — FAIL judgment using the window comparator

The test results are determined using the window comparator. The window comparator indicates a PASS judgment if the measured value is between the upper and lower reference limit values and indicates FAIL in any other case.

The tester is capable of issuing a FAIL judgment not only when it detects leakage currents above the preset upper reference limit, but also if a leakage current below the lower reference limit (which can be adjusted continuously up to 1/2 the upper reference limit). This allows the tester to provide PASS—FAIL judgments of test results even in cases involving broken wires in the test leads or contact failure. (This function does have limits and will not work past certain values.)

■ Displaying the cause of activation of the protective function as a code number

If the protective function is activated, the cause is given as a code number via the voltmeter. A code number is also indicated if there are discrepancies in setting test conditions, allowing you to promptly correct the setting based on the code number displayed.

■ Remote control

The optional remote control box or test probe allows testing to be started or stopped remotely.

■ Status signal output

The tester has output terminals for READY, H.V ON, PASS, FAIL, and PROTECTION signals to enable external monitoring of tester status.

Use this function with the remote control function to automate functions or to reduce actual hands-on testing requirements.

■ Sequence circuit with noise reduction features

For reliability, the sequence circuit incorporates thorough noise reduction features to prevent noise-induced malfunctions.

1.3 Options

Remote Control Boxes

Connecting a remote control box to the REMOTE connector of our Withstanding Voltage Testers, Insulation Resistance Testers, or Withstanding Voltage Insulation Resistance Testers, enables remote starting or stopping of testing.

The RC01-TOS has one START switch; the RC02-TOS has two START switches. With the RC02-TOS remote control box, testing can be started only when both START switches are pressed simultaneously.

Description of RC01-TOS/RC02-TOS	
OPERATE switch	The START switch is enabled only when this switch is ON. Turning this OFF halts testing.
START switch	When the OPERATE switch is ON and the tester is in a READY state, press this switch to begin testing.
STOP switch	This switch shuts off the output voltage or cancels a status (such as FAIL). It has the same function as the STOP switch on the tester.

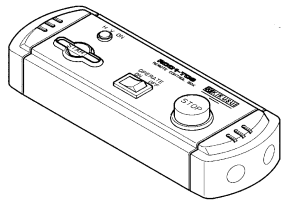

RC01-TOS
200(W) x 70(H) x 39(D) mm

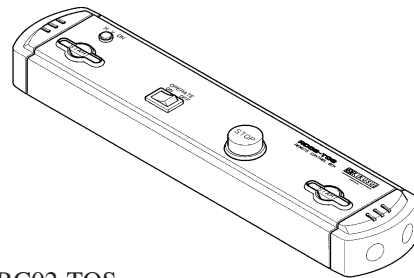

RC02-TOS
330(W) x 70(H) x 39(D) mm

High-voltage test probes

The HP01A-TOS and HP02A-TOS are test voltage output probes designed to be connected to our withstanding voltage tester.

The test probes are constructed so that a test voltage is output only when the slide lever at the grip of a test probe is held and the trigger is activated with one hand, and a switch on the upper part of the probe is pressed with the other; that is, operation requires two hands. Releasing either hand outputs a STOP signal, shutting off the tester's test voltage.

This features are intended to prevent inadvertent output of test voltages when using these probes.

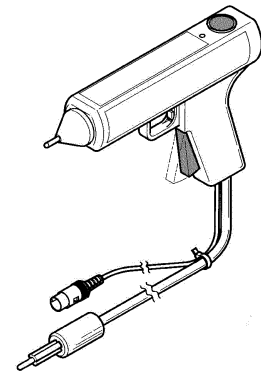

HP01A-TOS

Model number	Maximum usage voltage	Cable length
HP01A-TOS	4 kVac (rms) 50 Hz/60 Hz	Approx. 1.8 m
HP02A-TOS	5 kVdc	Approx. 3.5 m

-
- ⚠ WARNING** • When using a test probe, do not connect it to the DUT while a test voltage is being output from the probe. Also, do not disconnect the probe from the DUT while a test voltage is being output from the probe.

Disconnecting the probe from the DUT while high voltage is being output from the probe may result in damage to the DUT. Additionally, disconnecting the probe from the DUT in the middle of testing may result in a residual electrical charge in the DUT, posing a significant hazard.

For these reasons, the probe must be connected to the DUT before testing begins. When ending the test, confirm that the LED on the probe is not lit, then disconnect the probe from the DUT.

- NOTE** • To use a test probe, activate the FAIL MODE special test mode. With FAIL MODE activated, even releasing your hand from the probe when the test has ended in a FAIL judgment will not clear the FAIL state, thus allowing for secure identification of FAIL judgments. For more information, see “8.1.4 FAIL MODE” (page 51).
-

High-voltage test leads

Model number	Maximum usage voltage	Cable length	Remarks
TL01-TOS	5 kVac (rms) 50 Hz/60 Hz	Approx. 1.5 m	Equivalent of TOS8040 accessory
TL02-TOS	5 kVdc	Approx. 3.0 m	

Chapter 2 Installation and Preparations for Use

Describes how to unpack the tester for preparation before use.

2.1 Unpacking Inspection

Check the TOS8040 tester upon receipt for any damage that may have occurred during transit and to confirm that all accessories have been provided. If the product is damaged or if any accessories are missing, notify your Kikusui distributor or agent.

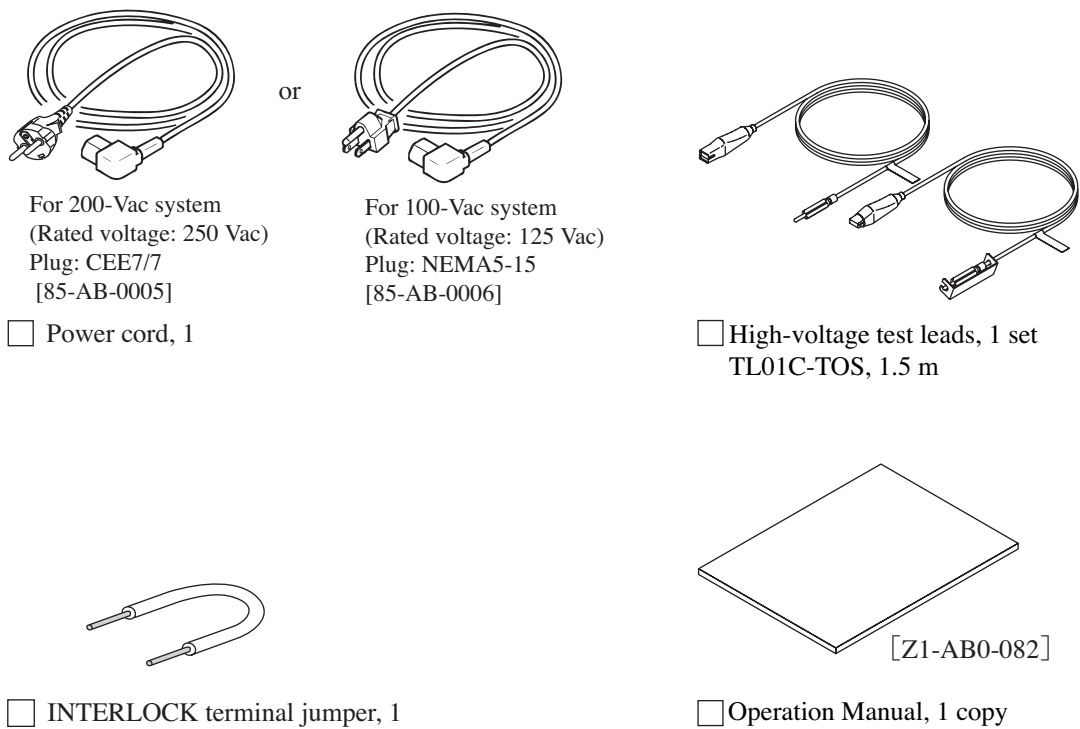

Fig.2-1 Accessories

NOTE • We recommend retaining all packing materials in case the product needs to be transported at a later date.

2.2 Precautions for Installation

Always observe the following precautions and conditions when installing the tester indoors:

■ **Do not use the tester in a flammable atmosphere.**

To prevent explosions or fires, never use the tester near combustible materials such as alcohol or thinner or in an atmosphere containing such vapors.

■ **Avoid locations subject to high temperatures or exposed to direct sunlight.**

Do not locate the tester near a heater or in areas subject to drastic temperature fluctuations.

Operating temperature range: 0°C to +40°C

Storage temperature range: -40°C to +70°C

■ **Avoid humid locations.**

Do not install the tester in high-humidity locations, including near boilers, humidifiers, or water supply.

Operating relative humidity range: 20% to 80% (with no dew condensation)

Storage relative humidity range: 90% or less (with no dew condensation)

Condensation may occur even within the operating humidity range. If so, do not use the tester until it is completely dry.

■ **Do not install the tester in a corrosive atmosphere.**

Do not install the tester in a corrosive atmosphere or in an atmosphere containing sulfuric acid mist or the like. Doing so may result in corrosion of conductors or improper connector contacts in the tester, resulting in malfunctions or failures and leading to potential fires.

■ **Do not install the tester in locations with excessive dust.**

Excessive dirt and dust may result in electric shock or fire.

■ **Do not use the tester in areas with poor ventilation.**

The tester uses an unforced air cooling system. Provide adequate space around the tester.

■ **Do not place any objects on the tester.**

In particular, heavy objects placed on the tester may lead to malfunctions.

■ **Do not install the tester on tilted surfaces or in locations subject to vibration.**

The tester may fall, resulting in damage or injury.

■ **Do not use the tester in locations subject to strong magnetic or electric fields.**

Using the tester in such locations may result in malfunctions, leading to electric shock or fire.

- **Do not use the tester in locations where sensitive measuring instruments or receivers are also being used.**

Use of the tester may affect the reliability or accuracy of such instruments or devices.

At a test voltage of more than 3 kV, corona discharges may occur that result in significant wide-range RF emissions between the clips of the test leads. To minimize these effects, keep the alligator clips as far apart as possible. Never allow an alligator clip or test lead to contact or approach the conductor surface (especially sharp metal ends).

- **Provide sufficient space around the power plug.**

Do not use excessive force to insert the power plug into an electrical outlet that resists insertion/extraction. Do not install objects near the plug that make plug insertion/extraction difficult.

2.3 Moving Precautions

When moving or transporting the tester to another installation site, observe the following precautions:

- **Turn the POWER switch off.**

Moving the tester with the power turned on may result in electric shock or damage.

- **Disconnect all wiring.**

Moving the tester with cables connected may result in breaks in the cables or may cause the tester to fall, which could result in injury.

- **When transporting the tester, always use the dedicated packing materials.**

Failure to use the dedicated packing materials may result in damage to the tester in the event of a fall or due to vibrations during transport.

2.4 Connecting the Power Cord

This product is designed to meet the standards for Overvoltage Category II (energy-consuming equipment to be supplied from fixed installation) of the IEC standards.

Checking the supply voltage

Before connecting the power cord, check the tester's supply voltage.

The tester's nominal input rating is indicated on the rear panel. The tester's standard specifications specify a supply voltage of 220 V.

SETTING SUPPLY	LINE VOLTAGE	FREQUENCY	VA MAX
STANDARD	220V	50/60Hz	650
<input checked="" type="checkbox"/>	120V		
<input type="checkbox"/>	100V		

If this field is marked, the supply voltage is 120 V.

-
- ⚠ CAUTION** • For the nominal input rating, the input voltage range for the tester to be able to operate correctly is required. Use beyond the input voltage range may result in malfunction or failure in addition to improper operation. Operate the tester with the supply voltage within the voltage range required. The waveform of the power source should be a sine wave having a peak value within 130% to 150% of the rms value. For information on the input voltage range to the nominal input rating, see “General Specifications” (page 55).
-

- NOTE** • The tester’s maximum rated output (4 kV at 100 mA) is specified at the nominal supply voltage. When the input voltage is less than the nominal input rating, the maximum rated output is not assured.
-

The tester is equipped with a high voltage output transformer of 500 VA. In the following two instances, large currents (several tens of amperes) may flow in the AC power line to which the tester is connected.

- A period of several tens of milliseconds during which the tester detects a FAIL judgment if the DUT is judged FAIL.
- The instant at which testing is conducted

In such cases, take into account the capacity of the AC power line and the power consumption of other electronic devices connected to that power line.

Connecting the power cord

-
- NOTE** • The power cord is a disconnecting device that disconnects the tester from the AC power line. Connect it to an easily accessible electrical outlet.
- Do not use the power cord provided with the product as a power cord for other equipment.
-

1. Check that the power supply meets the nominal input rating for the tester.
2. Turn the POWER switch off.
3. Connect the power cord to the AC INPUT connector on the tester’s rear panel.
4. Insert the power cord plug into an electrical outlet.

2.5 Grounding

Ground the tester by connecting the power cord to a properly grounded three-prong electrical outlet.

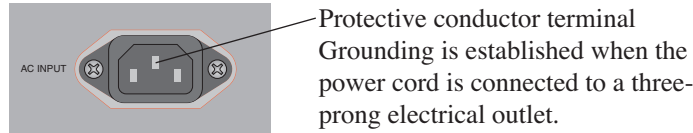

Fig. 2-2 Protective Conductor Terminal

-
- ⚠ WARNING** • This product is Safety Class I equipment (equipment with a protective conductor terminal) under IEC Standards. To prevent electric shock, always connect the product's protective conductor terminal to an electrical ground (safety ground).
-

■ Grounding is essential.

If the tester is used without grounding and output is inadvertently short-circuited to peripheral equipment such as a conveyor connected to ground or a nearby AC power line*, the tester's enclosure may be charged to hazardous voltages.

However, when the tester is properly grounded, it will not malfunction, and its enclosure will not be charged to high voltages even if the output is short-circuited to the ground via a peripheral, as noted above, or if the tester's LOW terminal and HIGH VOLTAGE terminal are short-circuited.

For these reasons, grounding the tester is essential to ensure safety.

-
- Description** * An AC power line is generally a power line connected to an electrical outlet to which the tester's power cord is connected. Here, it also refers to an AC line connected to a privately-owned electrical power generation device.
-

Gives the precautions to be observed at all times to ensure safe testing.

-
- ⚠ WARNING** • This tester supplies voltages as high as 4 kVAC or more to an external device during testing. Misuse may result in injury or death. To prevent such accidents, always observe the precautions given in this chapter. Use the tester with the utmost care and regard for safety.
-

3.1 Startup Inspection

Check the following items before testing:

Item	Description of inspection	Refer to:
Grounding	Confirm that the power cord has been connected to a properly grounded three-prong electrical outlet.	“2.5, Grounding” (page 20)
High-voltage test leads	Check for breaks, cracks, or other defects in the covering and for broken wires.	“3.3.1, Connecting the Test Leads” (page 22)
Displays and indicators	Confirm that all the displays and indicators light.	“5.1, Turning the POWER Switch On” (page 32)

3.2 Preparations Before Testing

3.2.1 Checking the Test Leads

Check for breaks, cracks, or other defects in the covering of the LOW-side test lead (black) and HIGH VOLTAGE-side test lead (red).

Use a tester to confirm that there are no broken wires in the test leads.

3.2.2 Wearing Rubber Gloves

-
- ⚠ WARNING** • When using the tester, always wear rubber gloves intended for electrical work to prevent electric shock.
-

If you have difficulty obtaining proper rubber gloves, consult your Kikusui distributor or agent.

3.3 Operating Precautions

3.3.1 Connecting the Test Leads

When connecting the test leads, observe the procedure given below to ensure secure connections.

1. Check the indications at the two locations shown in Fig. 3-1.

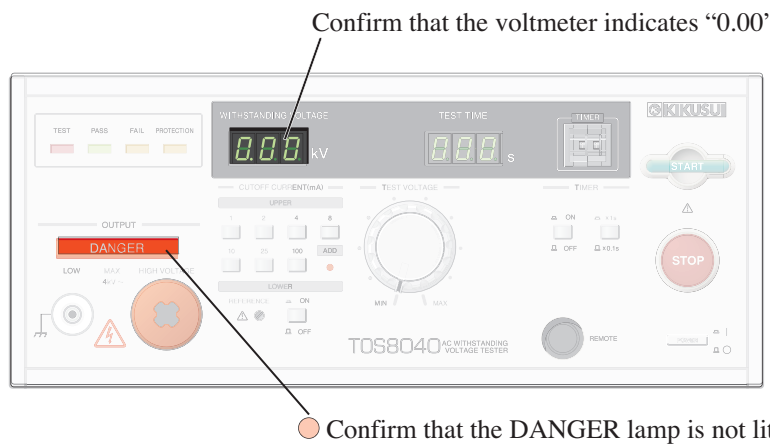

Fig.3-1 Checking that No High Voltage is Being Output

2. Insert the black test lead into the LOW terminal and attach an extraction prevention guard to the terminal, as shown in Fig. 3-2.

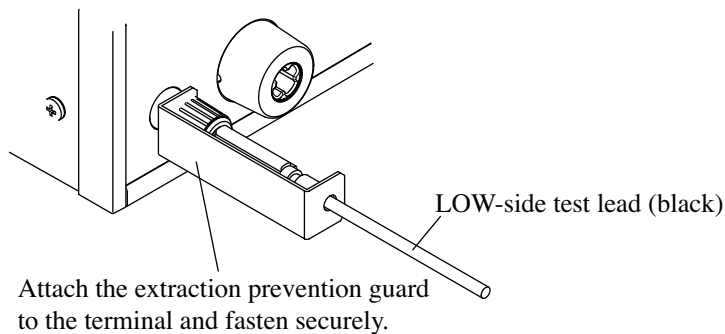

Fig. 3-2 Connecting the LOW-side Test Lead

3. Connect the black test lead to the DUT.

Note that improper test-lead connections may cause the entire DUT to be charged to dangerously high voltages.

4. Connect the red test lead to the DUT.

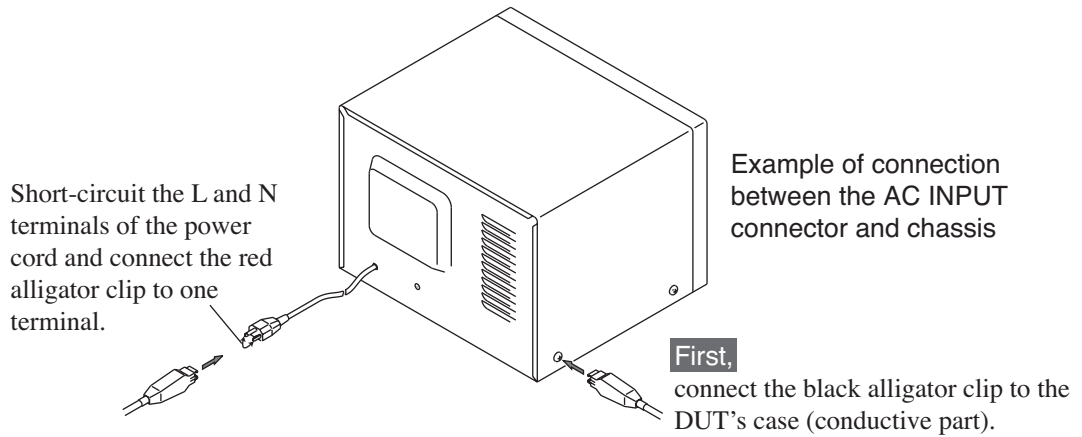

Fig. 3-3 Example of Connection to the DUT

5. Insert the red test lead into the HIGH VOLTAGE terminal.

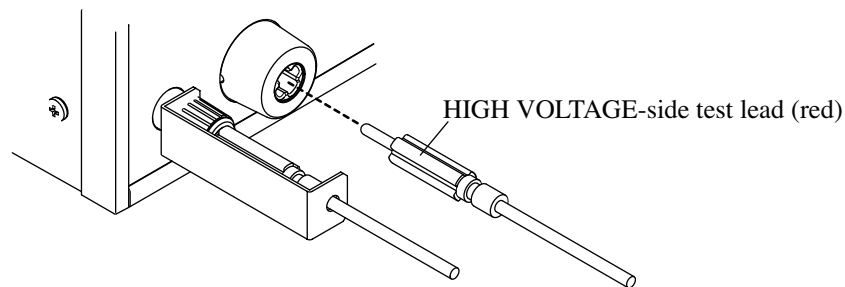

Fig. 3-4 Connecting the HIGH VOLTAGE-side test lead

■ To disconnect the test leads from the DUT

Disconnect the red test lead from the HIGH VOLTAGE terminal. You do not need to disconnect the black test lead from the LOW terminal.

3.3.2 For High Voltage Output

The TEST lamp goes on during testing. In this case, the DANGER lamp also lights up, alerting the operator that high voltages are being output.

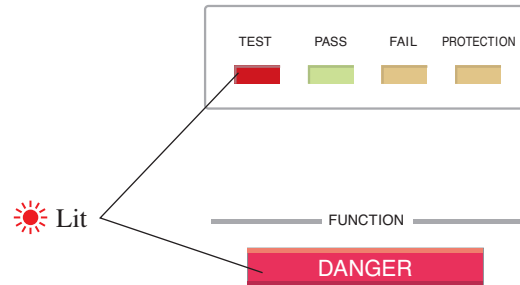

Fig. 3-5 Indicators Lit during Testing

When the DANGER lamp is lit



- **Do not touch the DUT, test lead, test probe, or any high-voltage-charged sections at the periphery of the output terminals.**

Contact with any of these areas may result in electric shock.

Never attempt to touch the PVC covering of the alligator clip of a test lead. (The dielectric strength is inadequate to prevent shock.)

During testing, never attempt to touch the alligator clip of a test lead.

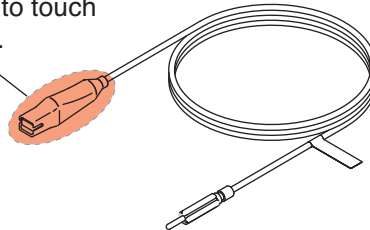

Fig. 3-6 Test Lead

- **Do not leave the tester while it is operating.**

A person who operates the tester must remain with it until the test is complete. If he/she must leave the tester, always turn the POWER switch off.

- **Do not turn the POWER switch off.**

Except in emergencies, do not turn the POWER switch off while output is being generated.

3.3.3 Checking Safety after Shutting off the Output

■ Checking indications at two locations

If you must touch the DUT, test lead, test probe, and/or a high-voltage-charged section such as the periphery of the output terminals for re-installing wiring, etc., check the indications at the two locations shown in Fig. 3-7 to ensure safety.

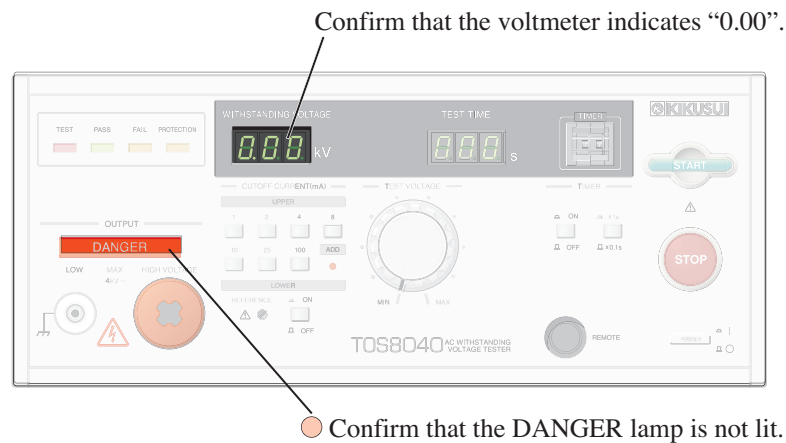

Fig. 3-7 Checking for the Absence of High Voltage

■ When disconnecting the test leads from the DUT

Disconnect the red test lead from the HIGH VOLTAGE terminal. You do not need to disconnect the black test lead from the LOW terminal.

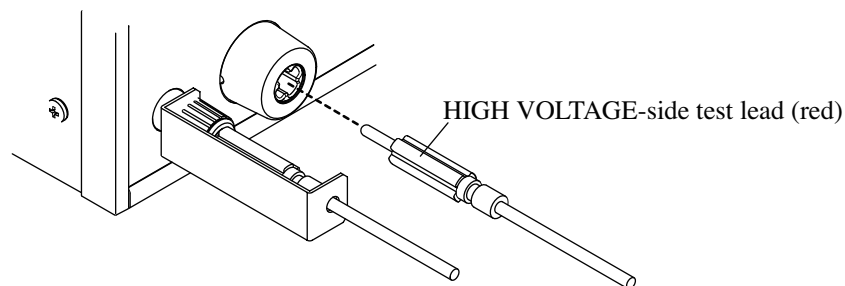

Fig. 3-8 Disconnecting the HIGH VOLTAGE-side Test Lead

3.4 When Interrupting Operations

If the tester will not be used for certain periods or if the operator is to leave the tester, turn the TEST VOLTAGE knob all the way counterclockwise (to the MIN position), then turn the POWER switch off.

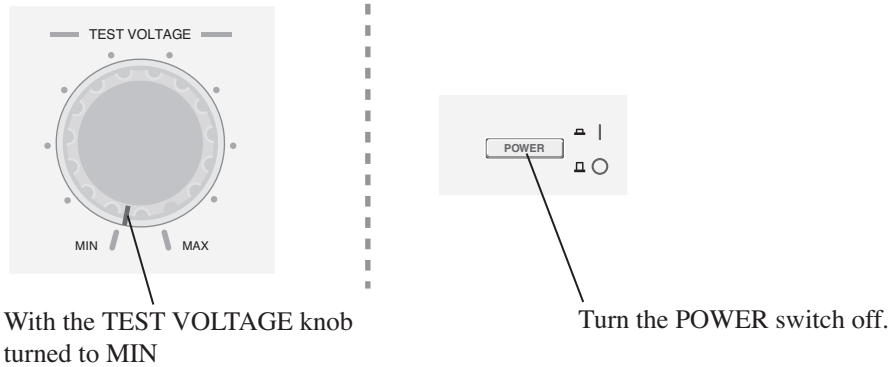

Fig. 3-9 When Interrupting Operations

3.5 Response to Emergencies

If electric shock occurs or the DUT is burned due to abnormalities in the tester, DUT, or other components, take the following two steps. Both must be performed, although either may be performed first.

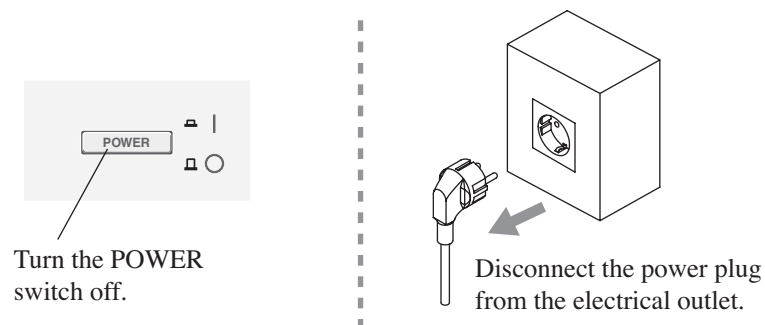

Fig. 3-10 Response to Emergencies

3.6 Stop Using the Tester in the Event of a Malfunction

Any of the following tester conditions may result in serious and hazardous malfunctions in which the tester's output cannot be shut off while high voltage is output. In such cases, immediately stop using the tester, turn the POWER switch off, and disconnect the power plug from the outlet.

- 1 The DANGER lamp remains lit even when the STOP switch is pressed.**
- 2 The DANGER lamp does not light, but the voltage is displayed on the voltmeter.**

The cause of condition 2 may simply be a defective DANGER lamp. Nevertheless, immediately stop using the tester to guard against the possibility of malfunctions resulting electric shock.

Additionally, if the tester fails to operate normally, suspend use immediately. In certain cases, high voltages may be output regardless of operator intention.

-
-  **WARNING**
- Implement safeguards so that no one will attempt to use the tester before it has been sent for repair.
 - Always contact your Kikusui distributor or agent to request repairs. To ensure safety, never attempt to repair the product yourself.
-

Gives the names of switches, terminals, and other controls of the TOS8040.

4.1 Front Panel

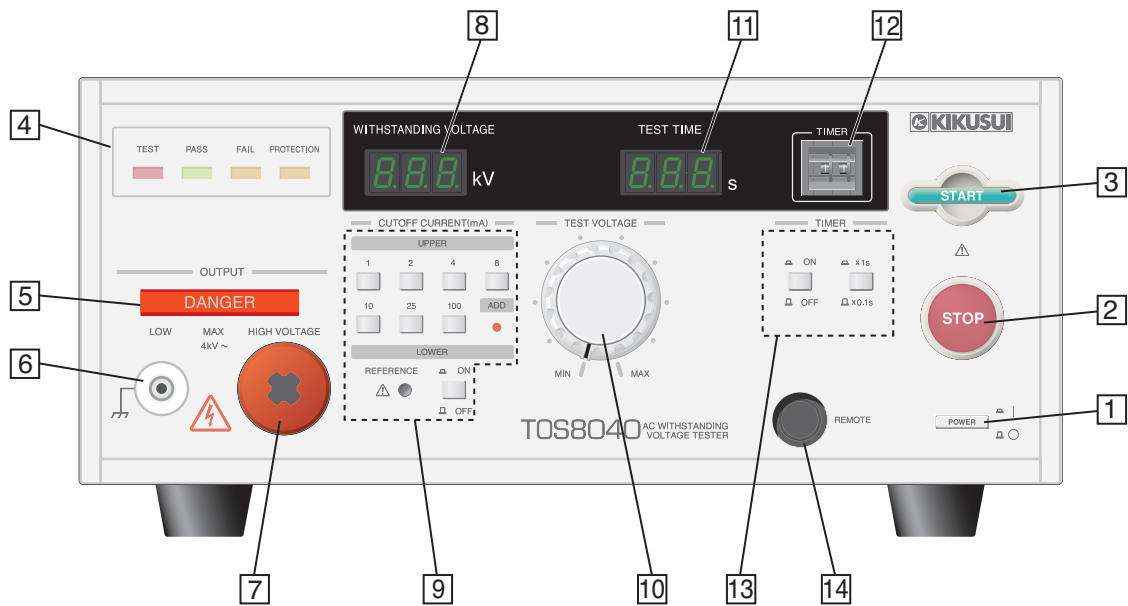

Fig.4-1 TOS8040 Front Panel

[1] POWER switch

Turns the tester power on/off. Depressing the switch turns power on (|). Before turning the POWER switch on, see “5.1 Turning the POWER Switch On” (page 32).

[2] STOP switch

This switch interrupts the test in progress. Pressing this switch transitions the tester from PASS, FAIL, or PROTECTION to the READY state. Tester states are defined in “5.2.1 Five States” (page 34).

[3] START switch

Press this switch when the tester is in the READY state to perform testing under the current test conditions. This switch is disabled for remote control operations.

[4] Indicators

Indicators indicate the selected test type and tester status. For more information, see “5.2 Tester States and Indications” (page 33).

TEST	Lights up when testing is in progress.
PASS	Lights up for approx. 200 ms* if the test result is determined to be PASS. * for standard setting
FAIL	Lights up when the test result is determined to be FAIL.
PROTECTION	Lights up when the protective function is activated.

[5] DANGER lamp

Lights up when high voltages are being output.

This lamp remains lit not just during actual testing, but for the period after interruption or completion of testing during which the output terminals retain a high voltage.

-
- ⚠ WARNING** • To prevent electric shock, always avoid contact with the DUT, test lead, test probe, and high-voltage-charged sections such as the periphery of the output terminals when the DANGER lamp is lit.
-

[6] LOW terminal

A low voltage terminal for outputting test voltages. Since it is connected directly to the chassis, grounding the protective conductor terminal of the power cord also grounds this terminal.

For more information, see “2.5 Grounding” (page 20).

[7] HIGH VOLTAGE terminal

A high voltage terminal for outputting test voltages

[8] Voltmeter

This voltmeter displays the output voltage, indicating the voltage at the HIGH VOLTAGE terminal.

If the tester enters the PROTECTION state, the voltmeter displays the reason for protective function activation by a code ranging from P01 to P12 (7 events).

[9] CUTOFF CURRENT (mA)

Used to set leakage current detection reference values.

UPPER	Used to set the upper reference limit. Allows selection of a limit value from 7 ranges of 1/2/4/8/10/25/100 mA. Pressing two or more switches sets a value equal to the algebraic sum of the selected ranges; the ADD lamp will light to indicate that the set value is an algebraic sum. For more information, see item “Current detection upper reference limit” (page 36).
LOWER	This area provides a switch for selecting whether to make a lower limit judgment and a variable resistor (VR) for setting the lower reference limit. The range of settings for the lower reference limit is from “0” to 1/2 of the upper reference limit set. When the VR is turned fully clockwise, the lower reference limit becomes 1/2 of the upper reference limit currently set. For more information, see item “Current detection lower reference limit” (page 37).

[10] TEST VOLTAGE knob

Regulates the test voltage.

Turning the knob clockwise from the MIN position increases output voltage. Unless testing is being performed, always turn the knob to the counterclockwise limit position (to the MIN position).

For more information, see item “Test voltage” (page 38).

[11] TEST TIME indicator

Displays test time.

This indicator displays the time elapsed from the start of the test for tests that do not use the timer, or remaining time for tests using the timer.

[12] TIMER

Sets the test time.

For more information, see item “Test time” (page 38).

[13] TIMER switch

Lets you select whether to use the timer.

The selected setting range (x0.1 / x1) is enabled when the TIMER switch is ON.

[14] REMOTE connector

Used to start or stop testing from a remote location.

For more information, see “6.1 Using the REMOTE Connector” (page 41).

4.2 Rear Panel

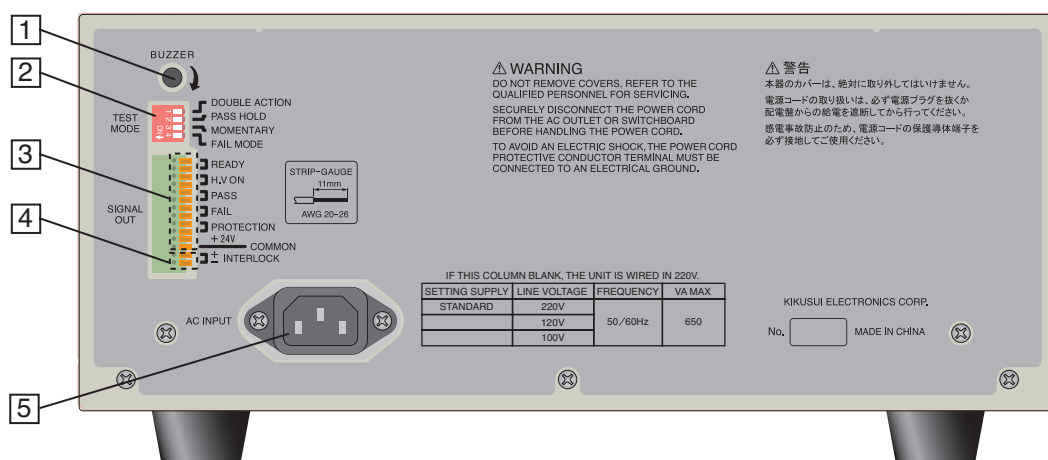

Fig. 4-2 TOS8040 Rear Panel

[1] BUZZER knob

Adjusts the volume of the buzzer that indicates a FAIL or PASS judgment.

Turning the knob clockwise makes the buzzer louder. The buzzer cannot be turned off.

[2] TEST MODE switches

Used to select four special test modes (DOUBLE ACTION, PASS HOLD, MOMENTARY, and FAIL MODE).

For more information, see “Chapter 8 Special Test Modes” (page 49).

[3] SIGNAL OUT terminal

Used to monitor the tester status externally.

There are five status terminals: READY, H.V ON, PASS, FAIL, and PROTECTION. A +24 V terminal is also provided to drive lamps or other devices during signal output.

For more information, see “Chapter 7 Status Signal Output” (page 46).

[4] INTERLOCK terminal

An interlock signal terminal.

Opening this interlock signal terminal causes the tester to enter the PROTECTION state (P01), disabling testing.

For more information, see “6.2 Using the INTERLOCK Terminal” (page 45).

[5] AC INPUT

An AC power input connector.

Connect the provided power cord to this connector.

For more information, see “2.4 Connecting the Power Cord” (page 18).

Describes procedures for testing.

5.1 Turning the POWER Switch On

1. Turn the TEST VOLTAGE knob all the way counterclockwise (to the MIN position), then turn the POWER switch on.

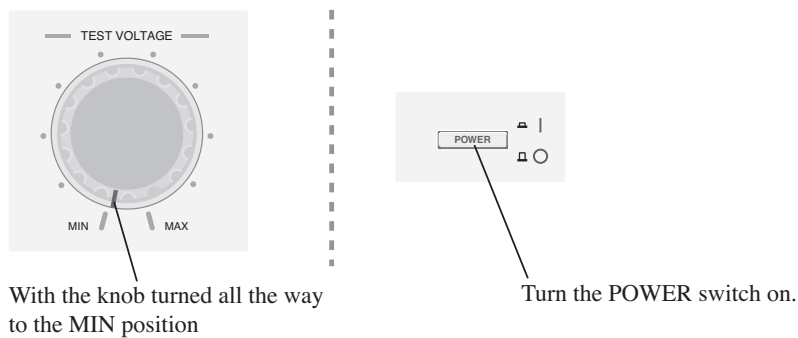
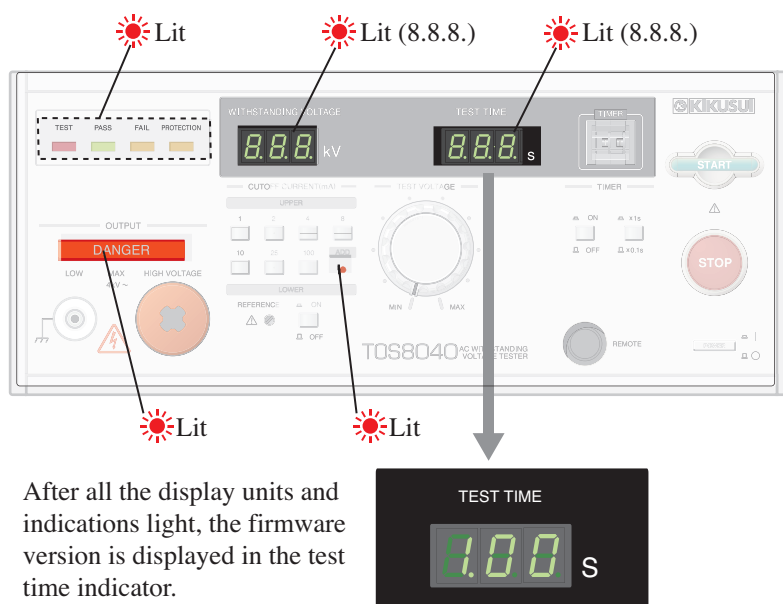

Fig.5-1 Check when Turning the POWER Switch On

2. Check that all display units and indications light appropriately.
If for any reason you fail to check their status, turn the POWER switch off, wait several seconds, then turn on once again.
After all the display units and indications light, the firmware version is displayed in the test time indicator. The tester then changes to display the test conditions currently set.



Example of indication of version 1.00

Fig. 5-2 Indications Displayed After POWER Switch is Turned On

■ **Do not turn the POWER switch on/off in quick succession.**

After turning the POWER switch off, wait several seconds before turning it on again.

Never perform a rapid on/off cycle of the POWER switch. The tester's protection function may be unable to protect the tester under these conditions, resulting in electric shock or other problems.

Except during an emergency, never turn the POWER switch off while voltage is being output.

5.2 Tester States and Indications

The front panel's indicators indicate tester state.

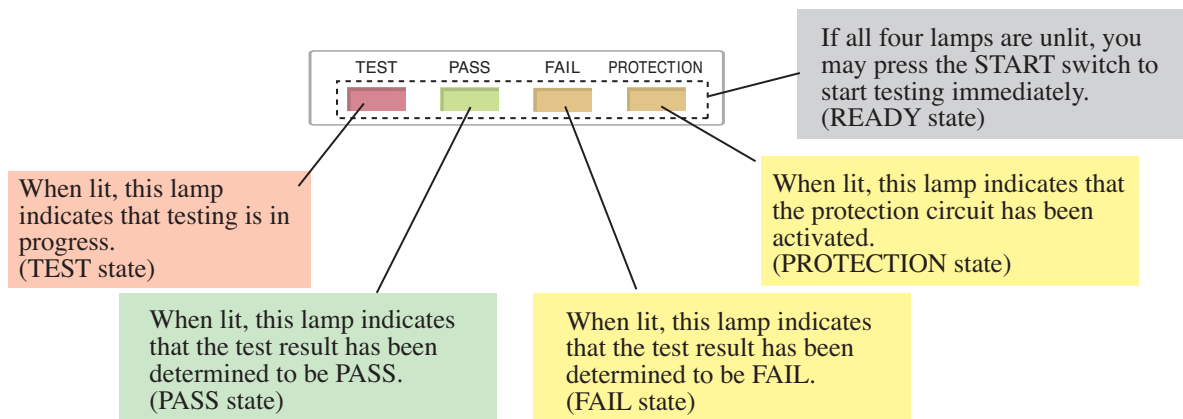

Fig. 5-3 Indicators on the Front Panel

5.2.1 Five States

This tester recognizes five tester states: TEST, PASS, FAIL, PROTECTION, and READY, which are defined below:

■ TEST state

State from start of to suspension or completion of testing

The TEST and DANGER lamps remain lit to indicate that a test voltage is being output. An H.V ON signal is generated.

■ PASS state

Indicates a state in which testing has ended and the result has been determined to be PASS.

The PASS lamp lights, a buzzer sounds, and a PASS signal is generated to indicate a PASS judgment. Note that this state is indicated only briefly (approx. 200 ms*) in the standard mode, after which the tester transitions to a READY state.

* If the PASS HOLD special test mode is activated, the PASS state is held until the STOP switch is pressed. For more information, see “8.1.2 PASS HOLD” (page 50).

■ FAIL state

Indicates a state in which testing has ended and the result has been determined to be FAIL.

The FAIL lamp lights, a buzzer sounds, and a FAIL signal is generated to indicate a FAIL judgment. The FAIL state can be canceled by pressing the STOP switch, after which the tester transitions to a READY state.

■ PROTECTION state

Indicates a state in which the protection function is activated.

The PROTECTION lamp lights, and a PROTECTION signal is generated to indicate that the tester is in the PROTECTION state. A code representing the cause of protection function activation is also displayed on the voltmeter in this state. For more information, see “5.2.2 Events or Conditions That Can Activate the Protection Function” (page 35).

The PROTECTION state can be canceled by pressing the STOP switch (or by inputting a STOP signal*), after which the tester transitions to a READY state.

* If the FAIL MODE special test mode is activated, the PROTECTION state cannot be cancelled by remote input of a STOP signal.

■ READY state

A READY signal is generated in this state.* All four lamps (TEST, PASS, FAIL, and PROTECTION) remain unlit.

Press the START switch in this state to start testing.

* If the DOUBLE ACTION special test mode is activated, a READY signal is generated for only approx. 0.5 second after the operator operates the STOP switch.

5.2.2 Events or Conditions That Can Activate the Protection Function

The following 7 events or conditions can activate the protection function. Each is assigned a unique code, which is displayed on the voltmeter.

If the protection function is activated, check the indicated code number and take appropriate measures in accordance with Table 5-1.

To clear the PROTECTION state, press the STOP switch.

-
- ⚠ WARNING** • If the PROTECTION lamp remains lit even after the event or condition activating the PROTECTION state has been removed and the STOP switch pressed, the tester may be defective. To ensure safety, immediately stop using the tester.
-

Table5-1 Events or Conditions Activating the Protection Function, and Remedies

Code Number	Possible Cause	Remedy
P01	The INTERLOCK terminal is open.	Take appropriate measures to close (short-circuit) the INTERLOCK terminal for the duration of the test.
P02	The test time has been set to a value of 0.4 s or less for a test involving the timer.	Set the test time to a value ranging from 0.5 s to 99 s.
P06	The value set for the upper reference limit has exceeded 105 mA.	Set the upper reference limit to a value ranging from 1 mA to 105 mA.
P07	The value set for the upper reference limit is 0 mA.	Set the upper reference limit to a value ranging from 1 mA to 105 mA.
P10	The REMOTE connector was inserted or extracted.	Turn the POWER switch off before connecting or disconnecting the plug to or from the REMOTE connector.
P11	The tester's internal temperature is too high.	Halt testing for a period equal to or longer than the test duration. For more information, see "Footnote *1" in "10.1 Basic Specifications" (page 53).
P12	A voltage of 4.3 kV or higher was output.	Adjust the output voltage to 4.0 kV or less using the TEST VOLTAGE knob.

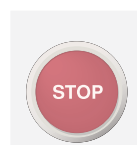
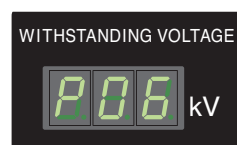

To cancel the PROTECTION state, press the STOP switch.

Fig. 5-4 Example of Display of Code "P06"

5.3 Procedure for Test

5.3.1 Test Parameters

The following parameters must be set.

Set these values according to the standards of the withstanding voltage test to be performed.

Parameter	Range
Current detection upper reference limit	1 mA to 105 mA
Current detection lower reference limit	OFF, 0 mA to 1/2 of the upper reference limit value set
Test time	TIMER OFF, 0.5 s to 99 s
Test voltage	0.05 kV to 4.00 kV

Current detection upper reference limit

If the measured leakage current exceeds the value set here, a FAIL determination is returned (upper limit judgment). Valid current values range from 1 mA to 105 mA. The current value can be set in 1 mA steps from 1 mA to 50 mA. Setting 0 mA (a condition in which no switch is pressed) or 106 mA or higher will cause the tester to enter a PROTECTION state (P07 or P06).

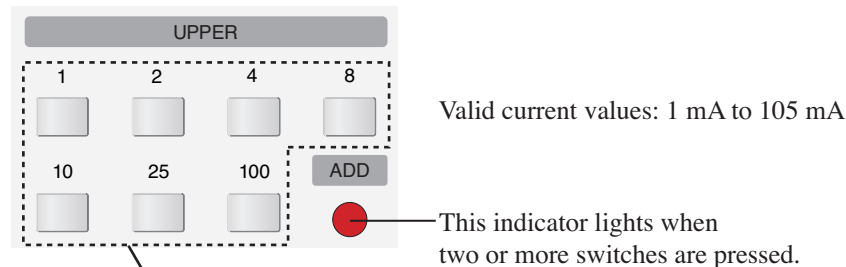

Press the appropriate switch(es) to set the reference current value (mA). Press multiple switches to set the value equal to the sum of the algebraic values corresponding to the switches pressed.
Example: Press the “1” and “100” switches to set a value of 101 mA.

Fig. 5-5 Setting a Current Detection Upper Reference Limit

NOTE

- If the operator sets a current value exceeding 50 mA, testing is subject to output time limitations. For more information, see “Footnote *1” in “10.1 Basic Specifications” (page 53).

Current detection lower reference limit

If the leakage current measured is less than the value set here, a FAIL determination is returned (lower limit judgment). Valid current values range from 0 mA to 1/2 of the upper reference limit value set. (The lower reference limit varies proportionally with the upper reference limit value.)

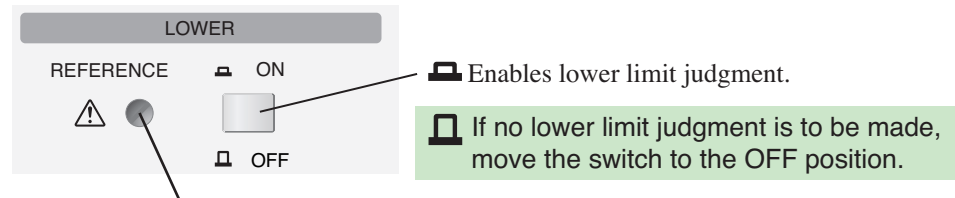

To set the lower reference limit, adjust the variable resistor (VR) using an adjustment screwdriver.

Valid current values: from 0 to 1/2 of the upper reference limit value set
Turning the VR all the way clockwise sets a current value equal to 1/2 of the upper reference limit value currently set.

Fig. 5-6 Setting a Current Detection Lower Reference Limit

NOTE

- If the lower reference limit is to be 1/2 of the upper reference limit value set, turn the VR all the way clockwise. To set the lower reference limit to other values, see “A.1 Setting the Current Detection Lower Reference Limit” (page 57).
-

■ Advantages of lower limit judgment

If the variation in leakage current values of the DUT is small and is more than the current value that can be recognized by the tester, test with the lower reference limit set to a value below the lower limit of variations. This allows identification of DUTs with exceptionally small leakage current or detection of contact failure or broken wires in the test leads for higher quality withstanding voltage testing.

5.3.1 Test Parameters (Continued)

Test time

When the time set here from the start of testing has elapsed, the test result is determined to be PASS, and the test is deemed complete. If the measured leakage current value exceeds the upper reference limit or falls below the lower reference limit, the test result is determined to be FAIL, even if the set test time has not yet expired, ending testing.

Valid test times range from 0.5 s to 99 s. Setting a test time of 0.4 s or less s will invoke the PROTECTION state (P02).

The time elapsed since the start of testing will be displayed for tests without timers, and the remaining time will be displayed for tests with timers.

If a test is ended in a FAIL state or PROTECTION state, the end time will remain on display until the STOP switch is pressed.

If you have pressed the STOP switch to abort the test, the test time will be displayed as "---".

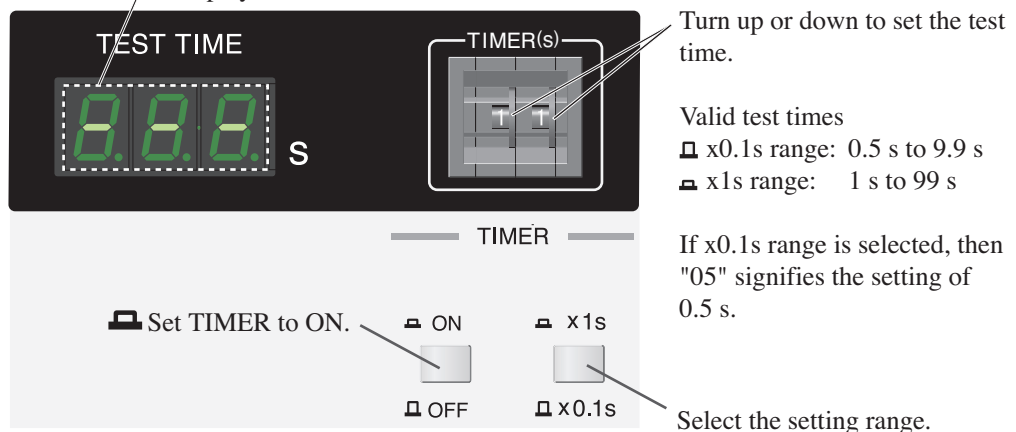

Fig. 5-7 Setting the Test Time

For testing in which the test time will exceed 99 s or in which no test time will be set, move the FUNCTION switch TIMER to the OFF position.

If the timer is not used, no PASS judgment will be made.

Test voltage

The voltage set here is applied to the DUT during the test.

-
- WARNING** • The test voltage must be set by actually outputting the voltage and reading the value on the voltmeter. For safety reasons, disconnect the test leads if they are connected to the output terminals.
-

NOTE

- The maximum output voltage of the tester at no-load rises above 4 kV. This value rises higher in proportion to power supply fluctuations, but it should always be set to a value ranging from 0.05 kV to 4.00 kV.

1. Bring the tester to the state shown in Fig. 5-8.

If the PROTECTION lamp is lit, press the STOP switch to cancel PROTECTION.

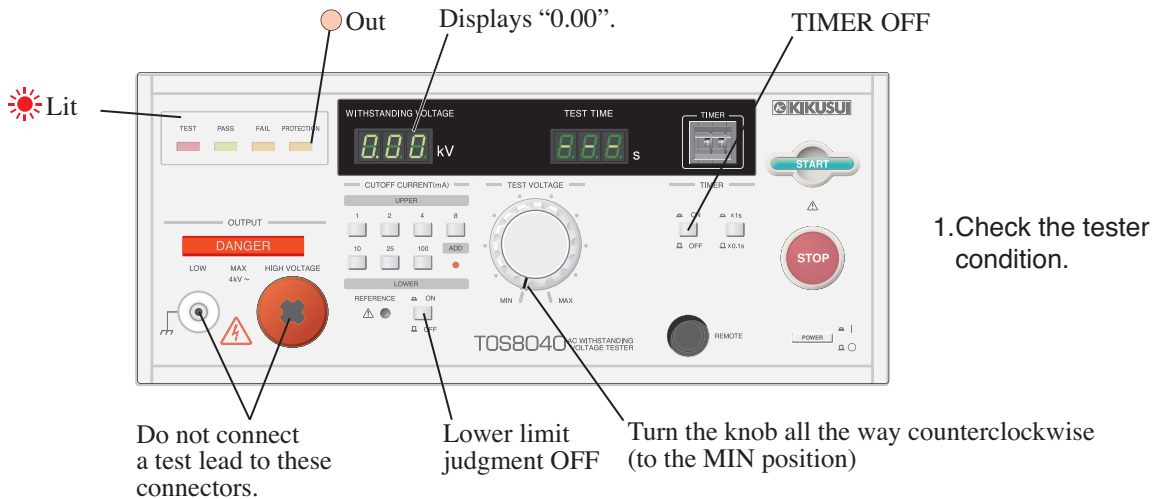

Fig. 5-8 Preparing for Test Voltage Setup

2. Press the START switch.

3. Monitoring the indication on the voltmeter, gradually turn the TEST VOLTAGE knob clockwise to set the test voltage.

4. Press the STOP switch to shut off the output.

If timer and/or lower limit judgment settings were changed in step 1 to set the test voltage, return the settings to their original values.

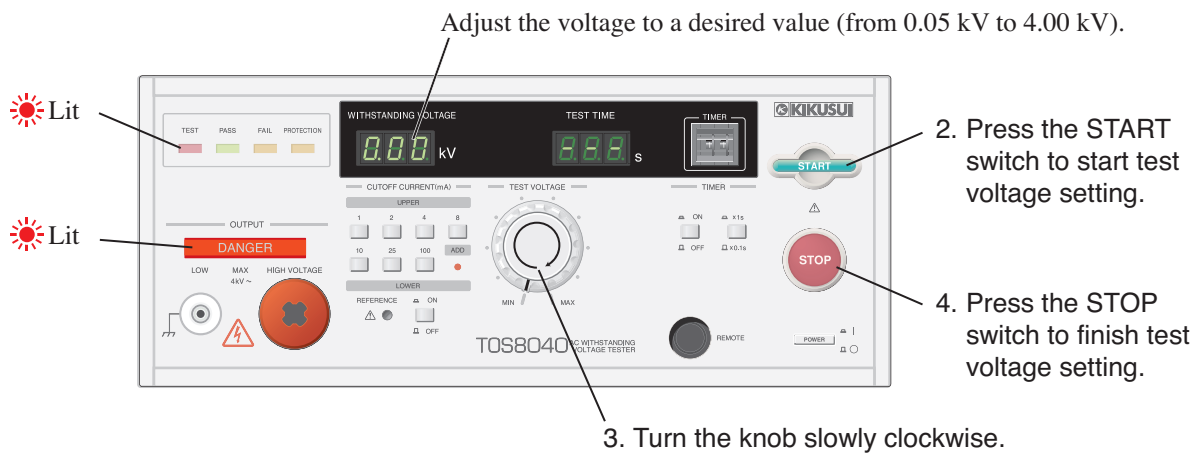

Fig. 5-9 Setting the Test Voltage

5.3.2 Connection to the DUT

Follow the procedure described in “3.3.1 Connecting the Test Leads” (page 22).

5.3.3 Starting the Test and Making Judgments

To start the test:

Press the START switch when the tester is in the READY state.

When a PASS judgment is made

When the time set by the timer has elapsed, the test voltage is shut off, causing a PASS determination to be returned. The PASS judgment is indicated in three ways: the PASS lamp lights, the buzzer sounds, and a PASS signal is generated.

In the standard test mode, the PASS state is indicated only briefly (approx. 200 ms), after which the tester immediately enters the READY state. To hold the PASS state until the STOP switch is pressed, activate the PASS HOLD special test mode. For more information, see “8.1.2 PASS HOLD” (page 50).

If a FAIL judgment is returned

If a leakage current exceeding the upper reference limit (or falling below the lower reference limit) flows through the DUT during testing, the test voltage is shut off, causing a FAIL determination to be returned. The FAIL judgment is indicated in three ways: the FAIL lamp lights, the buzzer sounds, and a FAIL signal is generated. The FAIL state is held until the STOP switch is pressed.



To stop the test:

To stop testing (shut off the output) for any reason after testing begins, press the STOP switch.

The following test types are also possible.

It is possible to conduct testing in which the test voltage is gradually increased from 0 V without using the timer. Note that, when setting test voltages of more than 50 mA, testing is subject to output time limitations. For more information, see “Footnote *1” in “10.1 Basic Specifications” (page 53).

Re-application of test voltage (re-testing)

As long as the tester is in a READY state, testing can be repeated under the current test conditions simply by pressing the START switch.

■ Before disconnecting the test leads from the DUT

Confirm that high voltage is not being output, referring to “3.3.3 Checking Safety after Shutting off the Output” (page 25).

Gives the procedure for operating the tester from a remote location using the REMOTE connector and the INTERLOCK terminal.

6.1 Using the REMOTE Connector

Always turn the tester POWER switch off before connecting or disconnecting an optional remote control box or other device to or from the REMOTE connector on the front panel.

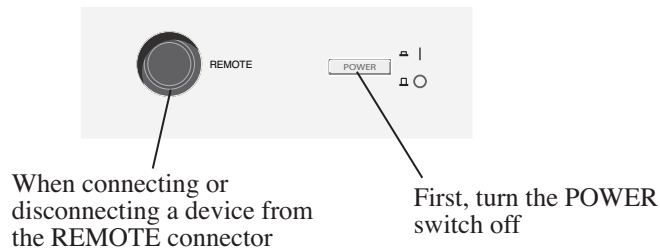

Fig. 6-1 REMOTE Connector and POWER Switch

NOTE

- If the FAIL MODE special test mode is activated during remote control, FAIL and PROTECTION cannot be cancelled with the STOP switch on the remote control box or by a STOP signal from the control device. For more information, see “8.1.4 FAIL MODE” (page 51).

6.1.1 Remote Control with the Optional Remote Control Box

The TOS8040 can be controlled from a remote location using an optional remote control box to start or stop testing.

Connecting the remote control box to the REMOTE connector on the front panel switches the tester from front panel control to remote control. Remote-controlled testing can be started or stopped as shown below:

	Front panel operation	Operations using the remote control box
Start testing	Disabled	START switch
Stop testing	STOP switch	STOP switch

For information on the optional remote control boxes, see “1.3 Options” (page 14).

6.1.2 Remote Control Using a Control Device

The tester can also be operated by remote control using a control device other than one of the listed optional remote control boxes.

-
- ⚠ WARNING** • Remote control operations involve outputting/shutting down high voltages by external signals. In certain cases, this may entail significant hazards. When high voltages are generated, thorough safety measures are required to prevent inadvertent generation of high voltages and human contact with the DUT, test lead, test probe, or the periphery of the output terminals. Do not operate the tester by remote control unless such measures can be assured.
-

Connecting a control device to the front panel's REMOTE connector switches the tester from front panel control to remote control. Remote-controlled testing using a control device is started or stopped as shown below:

	Front panel operation	Operations using a control device
Start testing	Disabled	START signal
Stop testing	STOP switch	STOP signal

For remote control via a control device, the descriptions given for START and STOP switch operations in other chapters (including chapter 5 "Panel Operations") are modified as follows:

Front panel operation	Remote control operations from a control device
Press the START switch.	Input a START signal.
Press the STOP switch.	Input a STOP signal, or press the STOP switch on the front panel.

Connecting a control device to the REMOTE connector requires a 5-pin, DIN Standard-based connector. Contact your Kikusui distributor or agent if you have difficulty obtaining a 5-pin DIN connector.

REMOTE connector pin configuration

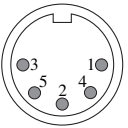
	Pin number	Signal name	Description
 <p>Viewed from the panel face</p>	1	NC	Leave this pin unconnected.
	2	COM	Common terminal
	3	ENABLE	Enables remote control at level L.
	4	START	Testing begins at level L.
	5	STOP	Stops testing at level L.

- The configuration of the REMOTE connector pin numbers are based on DIN Standards. Please note that the pins are not arranged by pin number.

NOTE

- If the REMOTE connector pin 3 is at level L, the tester switches from front panel control to remote control. Configure the control circuits so that pins 2 and 3 connect externally.

Control circuit example

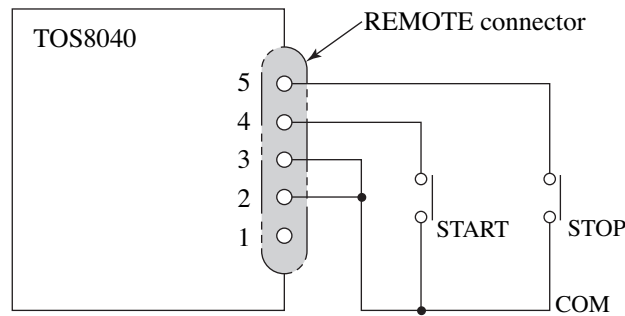

Fig.6-1 Example: Circuit 1

In this example, controlling the START and STOP contacts lets you operate the tester in the same way as from the front panel.

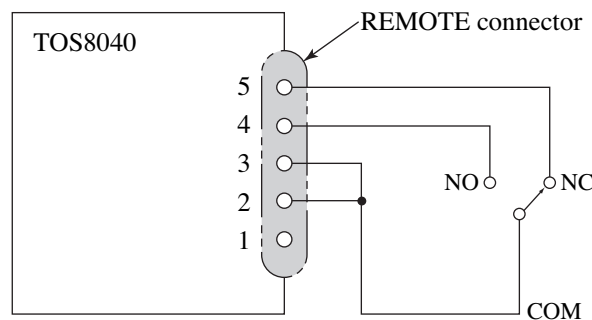

Fig. 6-2 Example: Circuit 2

In this example, setting the contact to the NO position invokes a TEST state; returning it to the NC position stops testing.

Logic elements, transistors, photocouplers, or other elements may take the place of contacts in Fig. 6-1. Fig. 6-3 shows one example.

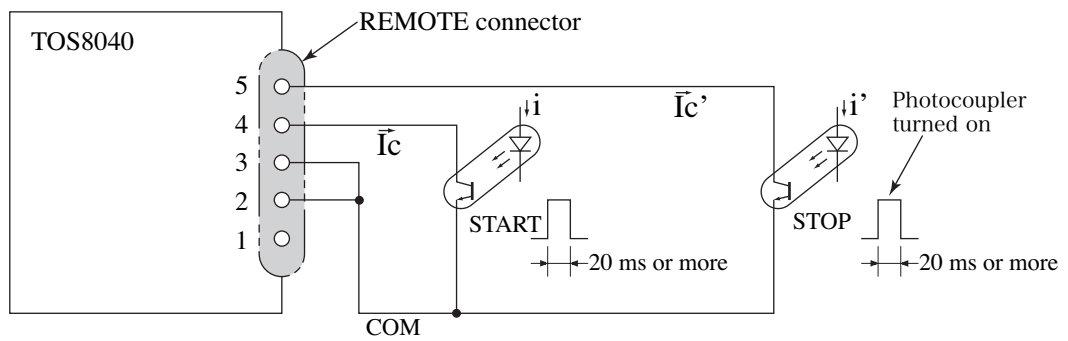

Fig. 6-3 Example: Circuit 3

REMOTE Connector Input Conditions	
H-level input voltage	11 V to 15 V
L-level input voltage	0 V to 4 V
L-level output-enable current	5 mA or less
Input time width	20 ms minimum

- Each gate is pulled up to +12 V. Opening the input terminals renders a state equivalent to H-level input.
- Consider i and i' so that 5 mA or greater flows through I_c and I_c' .
- To cancel a FAIL state, transmit a STOP signal of at least 20 ms in duration no sooner than 100 ms after the generation of a FAIL signal, as indicated in Fig. 6-4.

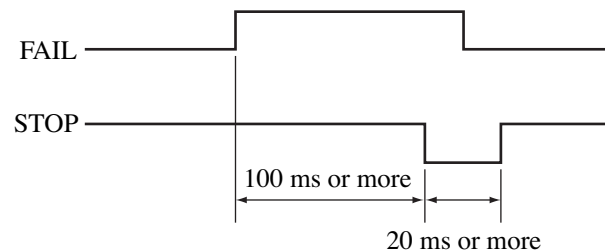

Fig. 6-4 Timing of a STOP Signal

Countermeasures against noise

For elements connected to the tester, using photocouplers as shown in Fig. 6-3 or relays as shown in Fig. 6-2 appears to be advantageous, in that they are capable of reducing the incidence of noise-induced system malfunctions.

The TOS8040 tester has been designed to minimize susceptibility to noise-induced malfunctions, whether originating from the tester itself or from a peripheral device. Nevertheless, to prevent malfunctions in connected devices, the user is advised to implement thorough measures to minimize noise.

6.2 Using the INTERLOCK Terminal

- ⚠ WARNING** • Short-circuiting the INTERLOCK terminals with the provided jumper is a convenient way to cancel the PROTECTION function, but this jumper should only be used when the tester is being temporarily operated for inspection. For safety, always enable the interlock function when performing actual testing.

To ensure user safety, the TOS8040 interlock function interlocks with external equipment to shut down output. When this function is activated, a PROTECTION state is invoked and output is shut off, preventing further testing. When this function is activated, the PROTECTION state cannot be cancelled simply by pressing the STOP switch on the front panel or by issuing a STOP signal from the remote control.

For improved safety, the interlock function allows testing to be controlled from an external device.

When using the tester, take advantage of the interlock function to improve operational safety. Consider the following examples:

- A cover covering the DUT is provided as an electric shock-prevention device; the status of the interlock function is linked to the opening and closing of the cover.
- Fences are installed around locations where testing is performed; the status of the interlock function is linked to the opening and closing of the fence.

Using the interlock function

Opening the INTERLOCK terminals on the rear panel activates the interlock function. This invokes the PROTECTION state.

To cancel the PROTECTION state invoked by the interlock function, short-circuit the terminals. Press the front panel STOP switch or send a STOP signal from the remote control.

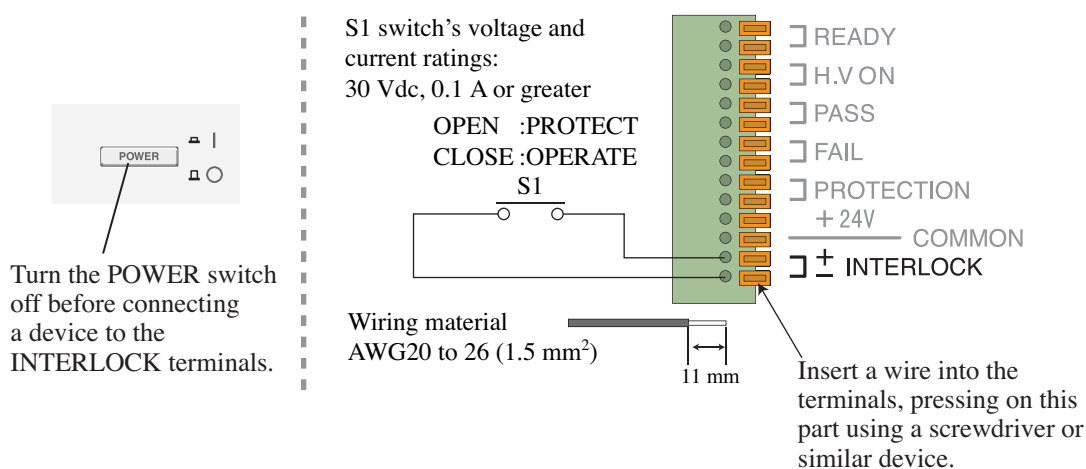

Fig. 6-5 Connecting a Device to the INTERLOCK Terminals

Describes the status signal outputs (SIGNAL OUT).

7.1 Five Signal Outputs

The following status signals are output from the SIGNAL OUT terminals on the rear panel. These signals are output in sync with the states defined in “5.2.1 Five States.” For more information on each state, see “5.2.1 Five States” (page 34).

READY signal

This signal is output when the tester is in a READY state.*

- * In the DOUBLE ACTION special test mode, a READY signal is generated for approx. 0.5 second after the operator presses the STOP switch. For more information, see “8.1.1 DOUBLE ACTION” (page 49).

H.V ON signal

This signal is output during testing or when high voltage remains in the output terminals (the DANGER lamp remains lit).

PASS signal

This signal is output when the test result is determined to be PASS.

In standard mode, a PASS signal is output for approx. 200 ms*, after which the tester shifts to a READY state, outputting a READY signal.

- * In the PASS HOLD special test mode, a PASS signal is output until the operator presses the STOP switch. For more information, see “8.1.2 PASS HOLD” (page 50).

FAIL signal

This signal is output when the test result is determined to be FAIL. A FAIL signal is output continuously until the tester enters a READY state or PROTECTION state.

PROTECTION signal

This signal is output when the tester is in a PROTECTION state.*

- * Connecting or disconnecting the REMOTE connector with the FAIL MODE special test mode set to off and the tester in a STOP state will result in no PROTECTION signal being output.

7.2 Using the SIGNAL OUT Terminals

7.2.1 Description of the Terminals

The SIGNAL OUT terminals are circuits in which a contact is closed when a signal is output (make contact signal), and there is no power supply in the internal circuits of SIGNAL OUT terminals. The terminals cannot drive a load without a power supply. See the internal circuit for each pair of terminals shown in Fig. 7-1.

The +24 V terminal can be used as a power supply for a lamp or similar device.

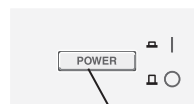
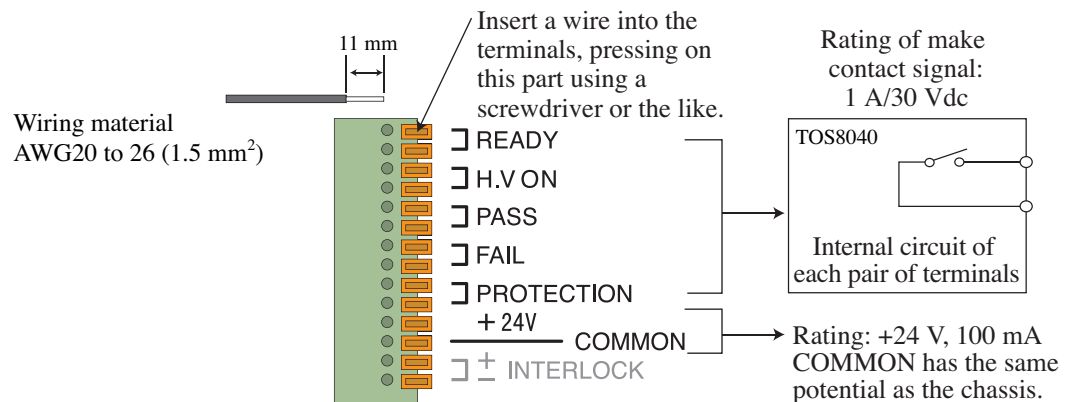

Turn the POWER switch off before connecting a wire to the SIGNAL OUT terminals.

Fig. 7-1 Connecting a Wire to the SIGNAL OUT Terminals

7.2.2 Example: Use of Signals

■ Driving a DC buzzer using a FAIL signal

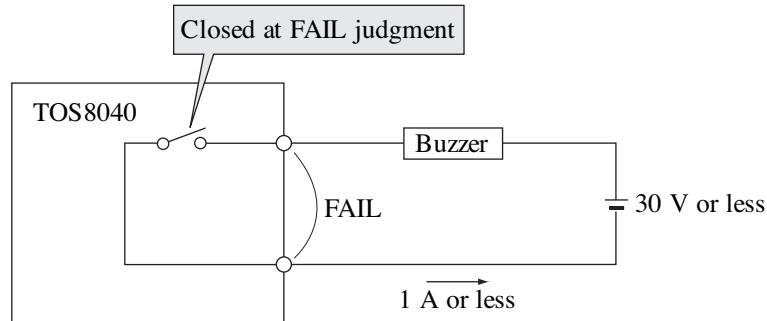

Fig. 7-2 Example: Use of FAIL Signal

■ Driving a lamp using an H.V ON signal

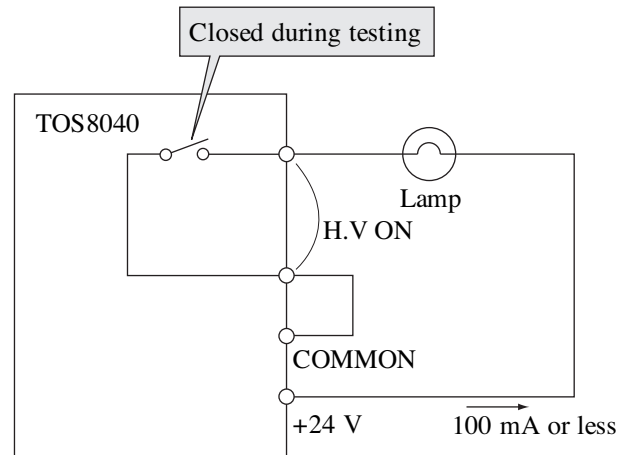

Fig. 7-3 Example: Use of an H.V ON Signal

■ Obtaining an L-level digital signal at signal output

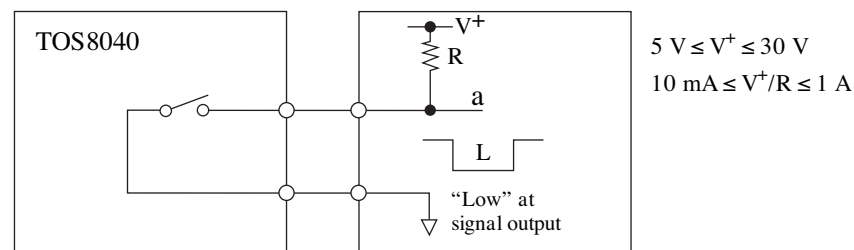

Fig. 7-4 Conversion into a Logical Signal

In Fig. 7-4, “L”-level output is obtained at point “a” at signal output. However, because a signal at point “a” contains contact chatter, measures for preventing contact chatter are required, which measures are compatible with the subsequent circuit to be connected. Moreover, the minimum applicable load for the contact is 5 V, 10 mA or greater. Thus, set V^+ and R values so that a load has this rating or above. Other cases may require additional measures against noise.

Explains the special test modes.

8.1 Four Test Modes

Four special TOS8040 tester test modes can be set using TEST MODE switches. Fig. 8-1 shows the standard switch configuration (default factory settings).

Moving switches 1 to 4 from the standard position to the ON position permits selection of the following four modes. These modes can be used in any combination.

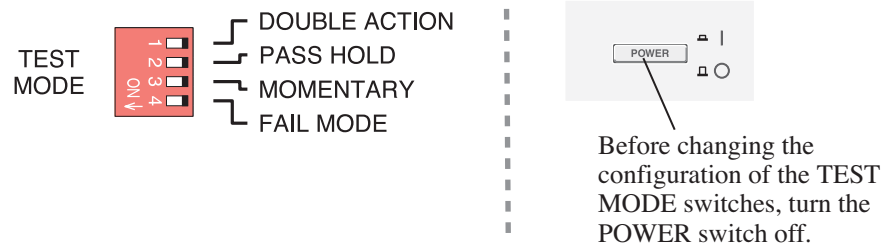

Fig. 8-1 Standard Settings of TEST MODE Switches

8.1.1 DOUBLE ACTION

Shown below are the differences in operation between the standard setting and this test mode:

Standard setting	DOUBLE ACTION
Start testing by pressing the START switch when the tester is in a READY state.	Simply pressing the START switch when the tester is in a READY state will not start testing. Testing starts only if the START switch is pressed within approx. 0.5 second after the STOP switch is pressed.

While operations are more complex in this mode, safety is improved. (This function works in the same way with remote control.)

NOTE

- If this test mode is set, a READY signal is generated for only approx. 0.5 second after the operator presses the STOP switch.

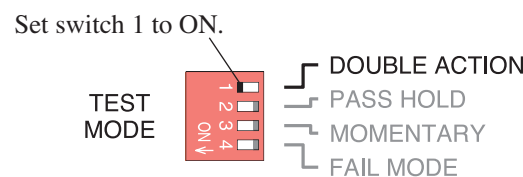

Fig. 8-2 Setting DOUBLE ACTION Test Mode

8.1.2 PASS HOLD

Shown below are the differences in operation between the standard setting and this test mode:

Standard setting	PASS HOLD
A PASS state is held for approx. 200 ms if the test result is determined to be PASS.	After the result is judged PASS, a PASS state is held until the operator presses the STOP switch.

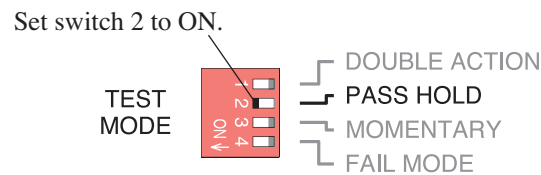

Fig. 8-3 Setting the PASS HOLD Test Mode

8.1.3 MOMENTARY

Shown below are the differences in operation between the standard setting and this test mode:

Standard setting	MOMENTARY
Once the START switch is pressed, a TEST state is held until the test time set with the timer elapses, or until the operator presses the STOP switch. The TEST state holds even if the START switch is released.	Testing can be performed only while the START switch is held down. Releasing the switch halts testing.

This operation ensures safety by requiring the operator to keep his/her hand on the START switch on the front panel during testing.

Use this function with the optional RC02-TOS (remote control box requiring two-hand operations) for even higher safety.

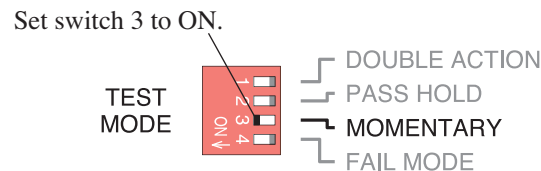

Fig. 8-4 Setting the MOMENTARY Test Mode

8.1.4 FAIL MODE

Shown below are the differences in operation between the standard setting and this test mode:

Standard setting	FAIL MODE
A STOP signal issued from the remote control can shut off output during testing or cancel a FAIL, PROTECTION, or PASS state just like the front panel STOP switch.	A STOP signal issued from the remote control can shut off the output during testing or cancel a PASS state, but cannot clear a FAIL or PROTECTION state. The FAIL or PROTECTION state must be cancelled by pressing the front panel STOP switch.

This function is useful for confirming a FAIL state when using the optional high-voltage probe HP01A-TOS or HP02A-TOS.

Set switch 4 to ON.



Fig. 8-5 Setting FAIL MODE Test Mode

Describes the maintenance and calibration of the tester. The tester must be periodically inspected, maintained, and calibrated to maintain performance.

9.1 Cleaning the Tester

-
- ⚠ CAUTION** • Always turn the POWER switch off before cleaning.
- Do not use volatile solvents such as thinners or benzine. They may discolor the tester surface coating, dissolve printed characters, or cause other problems.
-

If the panel becomes dirty, moisten a piece of soft cloth with a diluted mild detergent and gently wipe the panel.

9.2 Inspection

Power cord

Check that the cover is free of breaks and cracks and that the plug is free of cracks and looseness.

High-voltage test leads

Check that the covering is free of breaks and cracks. Check for broken wires in the test leads using a tester or other device.

-
- ⚠ WARNING** • A broken wire or breaks or cracking in the wire covering poses the risk of electric shock. If any such defect is observed, immediately stop using the power cord and/or test leads.
-

Please contact your Kikusui distributor or agent to purchase accessories.

9.3 Calibration

The TOS8040 tester is calibrated appropriately on shipment from the factory. However, the tester should be calibrated after long-term usage.

-
- ⚠ WARNING** • The tester generates voltages as high as 4 kV. Because internal inspection, parts replacement, and calibration is extremely hazardous, all such work should be performed by Kikusui service personnel.
-

Provides the electrical and mechanical specifications for the TOS8040.

The specifications are based on the following conditions and settings, unless otherwise specified.

- Warm-up time: 30 minutes
- Temperature: 5°C to 35°C
- Relative humidity: 20% to 80% (with no dew condensation)
- “xx% of reading” represents xx% of voltmeter reading.

10.1 Basic Specifications

Output section	
Output voltage range	0.05 kV to 4.00 kV/single range
Maximum rated load (*1)	400 VA (4 kV/100 mA) (at a nominal input rating)
Transformer capacity	500 VA
Output voltage waveform (*2)	AC line waveform
Voltage regulation	10% or less (during transition from the maximum rated load to no-load)
Short-circuit current	200 mA or more (at output voltage of 1.0 kV or more)
Switching	A zero-start switch is used.
Voltmeter	
Display	Digital three-digit indication
Measurement range	0.00 kV to 5.00 kV/two ranges
Display resolution	10 V
Accuracy	± 1.5% full scale or $V_m \geq 1.00 \text{ kV}: \pm (2\% \text{ of reading} + 10 \text{ V})$, $V_m < 1.00 \text{ kV}: \pm (2\% \text{ of reading} + 20 \text{ V})$ – whichever is smaller. <div style="text-align: right;">where V_m: measured voltage value</div>
Response	Mean value response/rms value indication

*1 Time limitations on the output

The heat radiation capacity of the output voltage generator section of the tester is designed to be 1/2 of the rated output, in consideration of the instrument dimensions, weight, costs, and other factors. The tester, therefore, must be used under the following time constraints (interval time and output time). If used beyond these limits, the output section may overheat, activating the internal protection circuit. In such cases, always halt testing for a duration equal to or greater than the test duration.

Ambient temperature (t)	Upper reference limit (i)	Interval time	Output time
$t \leq 40^\circ\text{C}$	$50 \text{ mA} < i \leq 105 \text{ mA}$	Equal to or greater than output time	10 minutes max.
	$i \leq 50 \text{ mA}$	Not necessary	Continuous output is possible.

*2 Test voltage waveform

If AC voltage is applied to a capacitive load, the output voltage in certain cases may rise above the value at no-load, depending on the value of the capacitive element of the load. Moreover, for samples whose capacitance values show voltage dependency (as with ceramic capacitors), waveform distortions may result. However, for a test voltage of 1.5 kV, the effects of a capacitance of 1000 pF or less may be ignored.

Judgment function	
Judgment method	Compares the reference values and measured leakage current using a window comparator. The result is returned as a PASS or FAIL.
Judgment action	FAIL judgment <ul style="list-style-type: none"> • If a current exceeding the upper reference limit or falling below the lower reference limit is detected: • The FAIL lamp is lit, • A FAIL signal is output from the SIGNAL OUT terminal (*3), and • The buzzer sounds. (*4)
	PASS judgment <ul style="list-style-type: none"> • When there are no abnormalities even after the set time has elapsed: • The PASS lamp is lit. • A PASS signal is output from the SIGNAL OUT terminal (*5), and • The buzzer sounds. (*4)
Upper reference limit	1/2/4/8/10/25/100 mA, 7 ranges May be set from 1 mA to 50 mA in 1 mA steps by a combination.
Lower reference limit	Continuously variable from 0 to 1/2 of the upper reference limit
Judgment accuracy (*6)	$\pm (5\% + 20 \mu\text{A})$ with respect to the upper reference limit $\pm 20\%$ with respect to the lower reference limit (*7)
Current detection method	Integrates the absolute current value to compare it to the reference value.
Calibration	Use a pure resistive load to make calibrations based on sine-wave rms values.
Output voltage at no-load that is required for detection (*8)	Approx. 300 V when set to 100 mA
Time	
Test time	x0.1s range: 0.5 s to 9.9 s; x1s range: 1 s to 99 s (the TIMER off function provided)
Resolution	x0.1s range: 0.1 s; x1s range: 1 s
Accuracy	-0 ms, +50 ms

*3 A FAIL signal is continuously output until STOP is input.

*4 The volume of a buzzer can be adjusted. However, it cannot be individually adjusted with respect to FAIL and PASS judgments.

*5 If PASS HOLD has been set, a PASS signal will be continuously output until STOP is input.

*6 In an AC withstanding voltage test, a current also flows in stray capacities such as measurement leads and devices. The approximate current values flowing in these stray capacities are as shown in the table below.

Output voltage	1 kV	2 kV	3 kV	4 kV
Main unit only (without measurement leads)	4 μA	8 μA	12 μA	16 μA
When a lead wire with a length of 350 mm is suspended in air (typical values)	6 μA	12 μA	18 μA	24 μA
When the provided TL01C-TOS or TL01-TOS lead wires are used (typical values)	20 μA	40 μA	60 μA	80 μA

*7 When the lower reference value is 1/2 of the upper reference limit (i.e., the variable resistor is turned fully clockwise). No calibration is made for other values.

*8 Voltage required to make FAIL judgment with the output terminals short-circuited due to internal resistance in the output circuit.

10.2 Other Functions

Remote control		
Connector	5-pin DIN connector on the front panel	
Control available	Start/stop of testing	
Optional devices connectable	Remote control boxes: RC01-TOS and RC02-TOS High-voltage test probes: HP01A-TOS and HP02A-TOS	
Signal I/O		
Connector	14-pin screw-less terminal on the rear panel	
Status signal output	Output of a READY signal / H.V ON signal / PASS signal / FAIL signal / PROTECTION signal Make-contact signal (contact rating: 1 A/30 Vdc)	
Power output terminal	Output of internal power (24 V at 100 mA) The COMMON terminal has a potential equal to the chassis potential.	
INTERLOCK input terminal	A PROTECTION state is invoked when the terminals are open.	
Special test modes		
DOUBLE ACTION	Starts testing only when the START switch is pressed within approx. 0.5 second after the STOP switch has been released.	
PASS HOLD	Holds PASS judgment.	
MOMENTARY	Performs testing only while the START switch is pressed.	
FAIL MODE	Disables cancellation of the FAIL or PROTECTION state caused by a remote STOP signal.	

10.3 General Specifications

Environment		
Operation environment		Indoor use, Overvoltage Category II
Specifications-assured range	Temperature	5°C to 35°C
	Relative humidity	20% to 80% (with no dew condensation)
Operating range	Temperature	0°C to 40°C
	Relative humidity	20% to 80% (with no dew condensation)
Storage range	Temperature	-40°C to 70°C
	Relative humidity	90% or less (with no dew condensation)
Altitude		Up to 2000 m
AC input		
Nominal input rating (Input voltage range)		220 V (200 V to 240 V), 120 V (110 V to 130 V), or 100 V (90 V to 110 V), 50 Hz or 60 Hz
Power consumption	At no-load (in READY state)	50 VA or less
	At rated load	650 VA maximum

Insulation resistance	AC INPUT to chassis	30 M Ω or more (at 500 Vdc)
Withstand voltage	AC INPUT to chassis	20 mA or less when 1390 Vac is applied for 2 seconds
Earth continuity		25 Aac/0.1 Ω or less
Dimensions (largest section)		320 (330) W x 132 (165) H x 370 (410) D mm
Weight		Approx. 17 kg
Accessories		<ul style="list-style-type: none"> • High-voltage test leads TL01C-TOS (approx. 1.5 m): 1 set • Power cord: 1 • INTERLOCK jumper: 1 • Operation Manual: 1 copy

10.4 Dimensions

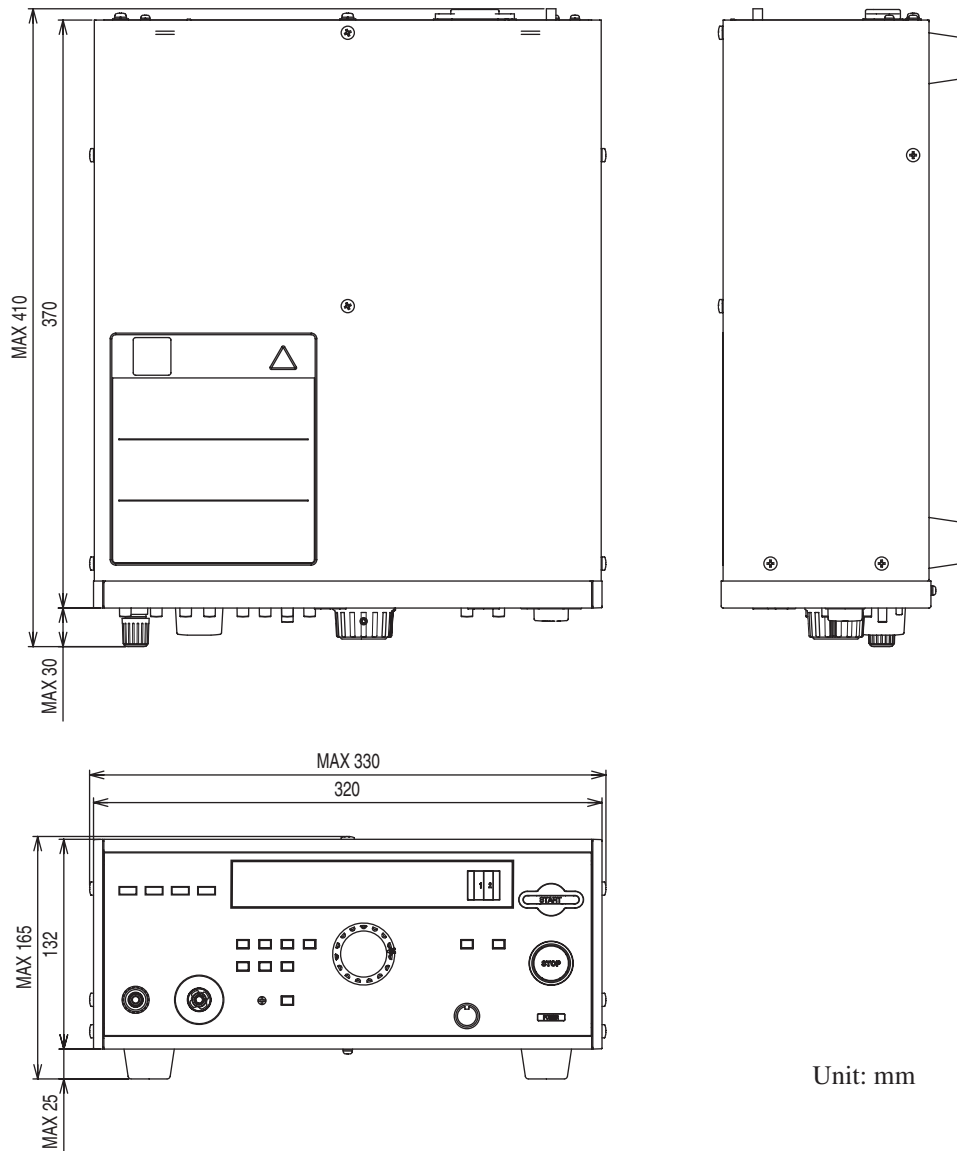

Appendix

Provides guidelines for current detection lower reference limit and zero-start switch.

A.1 Setting the Current Detection Lower Reference Limit

This section describes precautions for making lower limit judgments. It also describes how to set the current detection lower reference limit.

■ Precautions for lower limit judgment

If lower limit judgment is enabled in the following cases, the test result will be judged inappropriately as FAIL.

- Test voltage is set under no-load conditions.
- Virtually no current flows through the DUT.

Judgment error caused by stray capacity

In certain cases of high sensitivity and high voltage AC testing, a current flowing through stray capacities such as the test leads will exceed the lower reference limit, disabling lower limit judgment. Since no current flows through the DUT when the connection to the DUT is interrupted, the current flowing through the DUT should be less than the lower reference limit, which should result in a FAIL judgment. However, if a current exceeding the lower reference limit flows through stray capacities, the tester's current detection circuit detects that current, and the tester issues a PASS judgment. For information on stray capacities, see "Footnote *6" in "10.1 Basic Specifications" (page 53).

Be alert for comprehensive judgment errors. Check whether the tester issues a FAIL judgment when the connection to the DUT is interrupted at the setting of test conditions.

Setting the current detection lower reference limit:

1. Set the current detection upper reference limit.
See "Current detection upper reference limit" (page 36).
2. Adjust the front panel settings as shown in Fig. A-1.

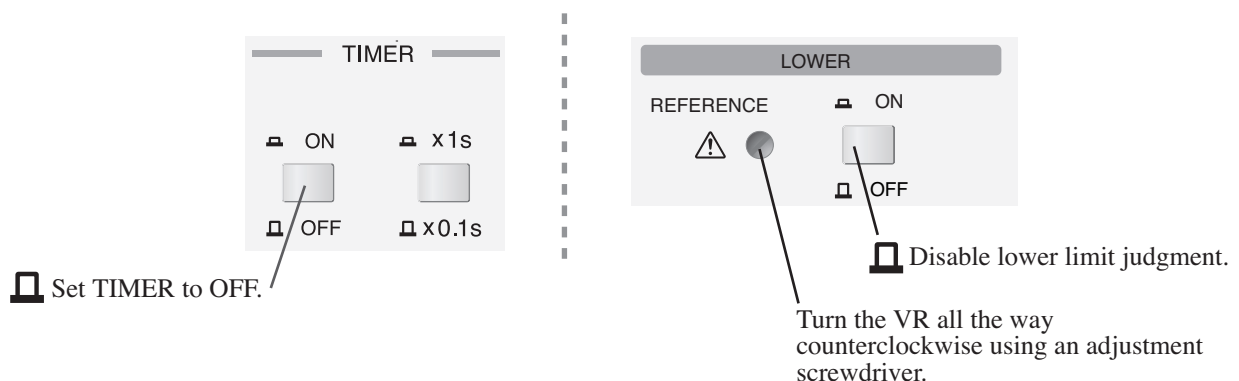

Fig. A-1 Preparing to Set the Current Detection Lower Reference Limit

3. Connect the DUT to the tester as described in “3.3.1 Connecting the Test Leads” (page 22).
4. Set the lower reference limit as indicated in the flowchart in Fig. A-2.

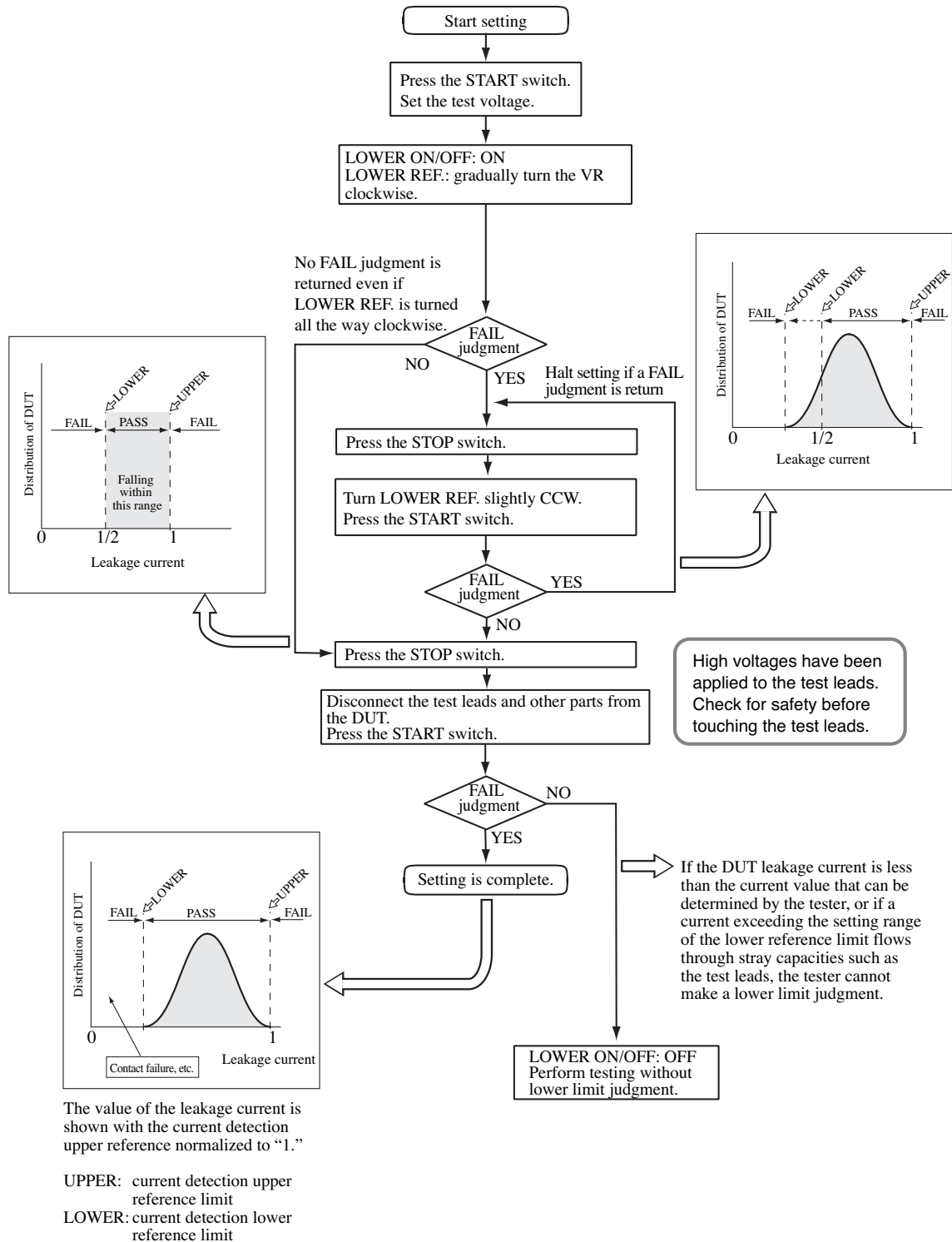

Fig. A-2 Flowchart for Setting the Current Detection Lower Reference Limit

A.2 Improvements in Waveform Obtained Using a Zero-start Switch

In the withstanding voltage tester, opening and closing the primary side of the high voltage transformer with a contact switch opens and closes the primary winding, distorting the output waveform. This results in the application of unnecessarily high voltage to the DUT, potentially damaging the DUT or resulting in a FAIL assessment for a good DUT.

To reduce distortion of test voltage waveforms, the TOS8040 tester uses a zero-start switch semiconductor to open or close a circuit when the supply voltage is near 0 V.

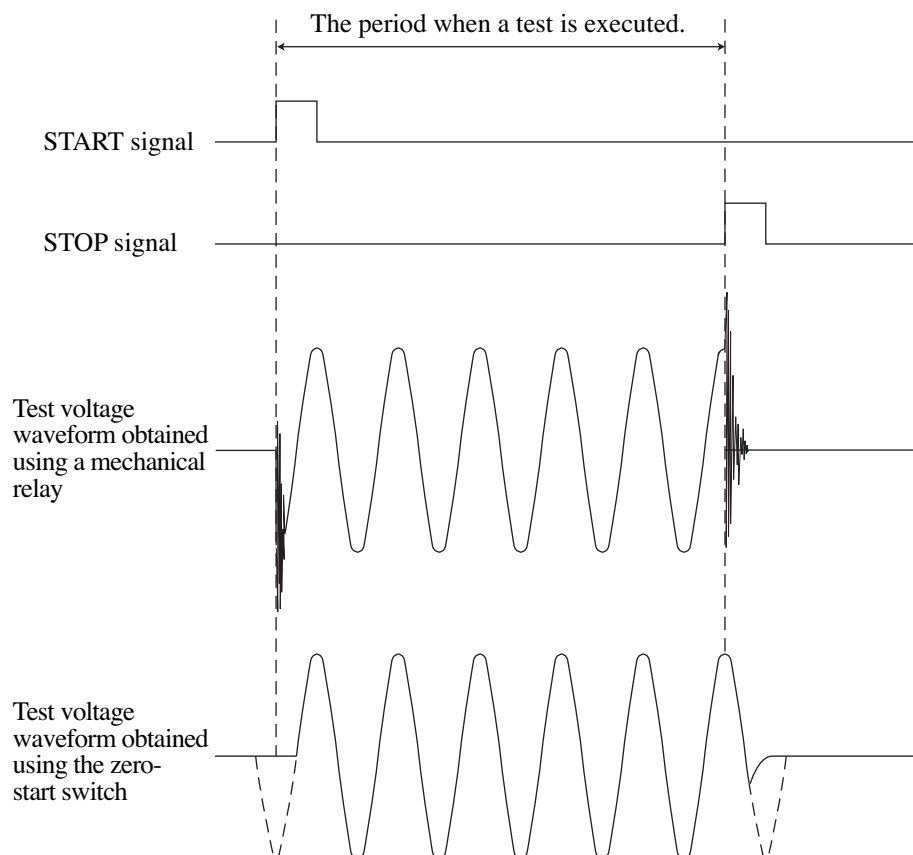

Fig. A-3 Improvements in Waveform Obtained Using the Zero-start Switch

Index

A

AC INPUT 31
accessories 16

B

BUZZER knob 31

C

calibration 52
cleaning 52
current detection lower reference limit 37, 57
current detection upper reference limit 36
CUTOFF CURRENT 30

D

DANGER lamp 24, 29
DOUBLE ACTION 49

E

emergencies 26

F

FAIL judgment 40
FAIL MODE 51
FAIL signal 46
FAIL state 34
firmware version 1, 32

G

grounding 20

H

H.V ON signal 46
hazardous operations 2
HIGH VOLTAGE terminal 29
high-voltage test lead 15
high-voltage test probe 14
HP01A-TOS 15
HP02A-TOS 15

I

indicators 29, 33
inspection 52
installation 17
interlock function 45
INTERLOCK terminal 31, 45
interrupting operations 26
interval time 53

L

LOW terminal 29
lower reference limit 37, 57

M

maintenance 52
making judgments 40
malfunction event 27
MOMENTARY 50
moving 18

O

output time 53

P

PASS HOLD 50
PASS judgment 40
PASS signal 46
PASS state 34
power cord 18
POWER switch 28, 32
protection function 35
PROTECTION signal 46
PROTECTION state 34

R

RC01-TOS 14
RC02-TOS 14
READY signal 46
READY state 34
REMOTE connector 30, 41, 43
remote control 41
remote control box 14
re-testing 40
rubber gloves 21

S

SIGNAL OUT terminal 31, 47
special test modes 49
START switch 28
starting the test 40
startup inspection 21
status signal output 46
STOP switch 28
stray capacity 54, 57
supply voltage 18

T

test lead 15
 -checking 21
 -connecting 22
TEST MODE switches 31, 49
test probe 14
TEST state 34
test time 38
TEST TIME indicator 30
test voltage 38
TEST VOLTAGE knob 30
test voltage waveform 53
time limitations 53
TIMER 30
TIMER switch 30
TL01-TOS 15
TL02-TOS 15

U

upper reference limit 36

V

voltmeter 29

W

window comparator 13

Z

zero-start switch 59