

R&S®FS-K73/K73+

3GPP FDD User Equipment Test

Software Manual



1154.7275.42 – 06

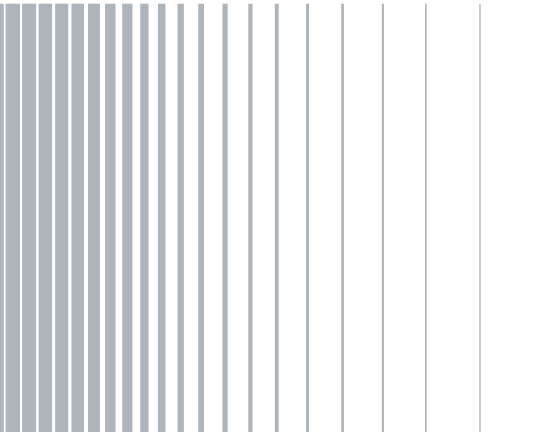

Test and Measurement
Software Manual
PAD-T-M: 3574.3259.02/01.00/C/1/EN

© 2014 Rohde & Schwarz GmbH & Co. KG

Muehldorfstr. 15, 81671 Munich, Germany

Phone: +49 89 41 29 - 0

Fax: +49 89 41 29 12 164

E-mail: info@rohde-schwarz.com

Internet: <http://www.rohde-schwarz.com>

Subject to change – Data without tolerance limits is not binding.

R&S[®] is a registered trademark of Rohde & Schwarz GmbH & Co. KG.

Trade names are trademarks of the owners.

The following abbreviations are used throughout this manual:

R&S[®]FS-K73/K73+ is abbreviated as R&S FS-K73/K73+

Contents

1	3GPP FDD User Equipment Test - Application Firmware R&S FS-K73/K73+	7
2	Enabling the Firmware Option	8
3	Getting Started	9
3.1	Basic Settings in Code Domain Measurement Mode	10
3.2	Measurement 1: Measuring the Signal Power	10
3.3	Measurement 2: Measurement of Spectrum Emission Mask	11
3.4	Measurement 3: Measurement of Relative Code Domain Power	11
3.4.1	Setting: Synchronizing the reference frequencies	12
3.4.2	Setting: Behaviour with Deviating Center Frequency Setting	13
3.4.3	Setting: Behaviour with Incorrect Scrambling Code	13
3.5	Measurement 4: Triggered Measurement of Relative Code Domain Power	14
3.5.1	Setting: Trigger offset	14
3.6	Measurement 5: Measurement of Composite EVM	15
3.7	Measurement 6: Measurement of Peak Code Domain Errors	16
3.8	Measurement 7: Measurement of the Trigger To Frame Time	17
3.8.1	Resolution of the TTF time measurement	17
3.8.2	Absolute accuracy of the TTF time measurement	18
3.8.3	Trace statistic in the RESULT SUMMARY display	19
4	Setup for User Equipment Tests	20
4.1.1	Standard Test Setup	20
4.1.2	Presetting	21
5	3GPP FDD Channel Configurations	22
6	Menu Overview	24
7	Configuration of 3GPP FDD Measurements	27
7.1	Measurement of Channel Power	28
7.2	Measurement of Adjacent-Channel Power - ACLR	29
7.3	Signal Power Check – SPECTRUM EM MASK	38
7.4	Measurement of Occupied Bandwidth - OCCUPIED BANDWIDTH	41
7.4.1	Measurement of Signal Statistics	44

7.5	Code Domain Measurements on 3GPP FDD Signals	48
7.5.1	Display modes – <i>RESULTS</i> hotkey	50
7.5.2	Measurement Configuration – <i>CHAN CONF</i> hotkey	79
7.5.3	Configuration of CDP Measurement – <i>SETTINGS</i> hotkey	84
7.5.4	Frequenz-Einstellung – Key <i>FREQ</i>	89
7.5.5	Span Settings – Key <i>SPAN</i>	90
7.5.6	Level Settings – Key <i>AMPT</i>	90
7.5.7	Marker Settings – Key <i>MKR</i>	91
7.5.8	Changing Instrument Settings – Key <i>MKR</i> →	93
7.5.9	Marker Functions – Key <i>MKR FCTN</i>	94
7.5.10	Bandwidth Setting – Key <i>BW</i>	94
7.5.11	Measurement Control – Key <i>SWEEP</i>	94
7.5.12	Measurement Selection – Key <i>MEAS</i>	94
7.5.13	Trigger Settings – Key <i>TRIG</i>	94
7.5.14	Trace-Einstellungen – Key <i>TRACE</i>	95
7.5.15	Display-Lines – Key <i>LINES</i>	97
7.5.16	Settings of Measurement Screen – Key <i>DISP</i>	97
7.5.17	Storing and Loading of Unit Data – Key <i>FILE</i>	98
8	Remote-Control Commands	99
8.1	CALCulate – Subsystem	99
8.1.1	CALCulate:FEED – Subsystem	99
8.1.2	CALCulate:LIMit – Subsystem	101
8.1.3	CALCulate:MARKer – Subsystem	108
8.1.4	CALCulate:PEAKsearch – Subsystem	109
8.1.5	CALCulate:STATistics - Subsystem	110
8.2	CONFigure:WCDPower Subsystem	112
8.3	DISPlay - Subsystem	117
8.4	INSTrument Subsystem	118
8.5	SENSe - Subsystem	118
8.5.1	SENSe:CDPower Subsystem	118
8.5.2	SENSe:POWer - Subsystem	124
8.6	STATus-QUEStionable:SYNC Register	131
8.7	TRACe Subsystem	133
8.8	Table of Softkeys with Assignment of IEC/IEEE Commands	140
9	Performance Test	148
9.1	Required Measuring Equipment and Accessories	148

9.2 Test Procedure.....149

10 Glossary 151

11 Index 153

1 3GPP FDD User Equipment Test - Application Firmware R&S FS-K73/K73+

The Spectrum Analyzer R&S FSP, R&S FSU, Signal Analyzer R&S FSQ or Measuring Receiver R&S FSMR equipped with Application Firmware R&S FS-K73 perform code domain power measurements on uplink signals according to standard 3GPP (FDD mode). The application firmware is in line with standard 3GPP (Third Generation Partnership Project) with version Release 5. In addition to the code domain measurements prescribed by the standard 3GPP, the application offers measurements with predefined settings in the frequency domain, e.g. power and ACLR measurement. The Application Firmware R&S FS-K73+ additionally allows measurements according to Release 7 including EDPDCH channels with modulation format 4PAM. R&S FS-K73 must be installed before installing R&S FS-K73+ on the R&S Analyzer

2 Enabling the Firmware Option

Firmware Option R&S FS-K73 is enabled in the GENERAL SETUP menu by entering a keyword. The keyword is delivered with the option. R&S FS-K73 and R&S FS-K73+ have different keywords. R&S FS-73 must be installed before R&S FS-K73+ is installed. If one option is factory-installed, it is already enabled.

GENERAL SETUP menu

OPTIONS

The OPTIONS softkey opens a submenu where keywords for new firmware options (application firmware modules) can be entered. Available options are displayed in a table, which is opened when entering the submenu.

INSTALL OPTION

The INSTALL OPTION softkey activates the entry of the keyword for a firmware option.

One or several keywords can be entered in the entry field. On entering a valid keyword, OPTION KEY OK is displayed on the message line and the option is entered in the FIRMWARE OPTIONS table.

In case of invalid keywords, OPTION KEY INVALID is displayed on the message line.

3 Getting Started

The following chapter explains basic 3GPP FDD user equipment tests by means of a setup with signal generator R&S SMIQ. It describes how operating and measurement errors can be avoided using correct presetting.

The measurement screen is presented in chapter 6 for each measurement.

Key settings are shown as examples to avoid measurement errors. Following the correct setting, the effect of an incorrect setting is shown. The following measurements are performed:

- Measurement 1: Measuring the spectrum
- Measurement 2: Measurement of spectrum emission mask
- Measurement 3: Measurement of relative code domain power
 - Setting: Setting the analyzer center frequency to the DUT frequency
 - Setting: Scrambling code of signal
- Measurement 4: Triggered measurement of relative code domain power
 - Setting: Trigger offset
- Measurement 5: Measurement of composite EVM
- Measurement 6: Measurement of peak code domain error

The measurements are performed using the following units and accessories:

- R&S Analyzer with Application Firmware R&S FS-K73: 3GPP FDD user equipment test.
- Vector Signal Generator R&S SMIQ with option R&S SMIQB45: digital standard 3GPP
- (options R&S SMIQB20 and R&S SMIQB11 required)
- 1 coaxial cable, 50 Ω , approx. 1 m, N connector
- 1 coaxial cable, 50 Ω , approx. 1 m, BNC connector

Conventions for displaying settings on R&S Analyzer:

- [<KEY>]** Press a key on the front panel, e.g. [SPAN]
- [<SOFTKEY>]** Press a softkey, e.g. [MARKER -> PEAK]
- [<nn unit>]** Enter a value and terminate by entering the unit, e.g. [12 kHz]

Conventions for displaying settings on R&S SMIQ:

- [<KEY>]** Press a key on the front panel, e.g. [FREQ]
- <MENÜ>** Select a menu, parameter or a setting, e.g. DIGITAL STD.
The menu level is marked by an indentation.
- <nn unit>** Enter a value and terminate by entering the unit, e.g. 12 kHz

3.1 Basic Settings in Code Domain Measurement Mode

In the default setting after PRESET, the R&S Analyzer is in the analyzer mode. The following default settings of the code domain measurement are activated, provided the code domain measurement mode is selected.

Table 3-1: Default settings of the code domain measurement

Parameter	Setting
Digital standard	W-CDMA 3GPP REV
Sweep	CONTINUOUS
CDP mode	CODE CHAN AUTOSEARCH
Trigger settings	FREE RUN
Trigger offset	0
Scrambling code	0
Threshold value	-60 dB
Symbol rate	15 ksps
Code number	0
Slot number	0
I/Q branch	Q
Display	Screen A: CODE PWR RELATIVE Screen B: RESULT SUMMARY

3.2 Measurement 1: Measuring the Signal Power

The measurement of the spectrum gives an overview of the 3GPP FDD signal and the spurious emissions close to the carrier.

Test setup ▶ Connect the RF output of R&S SMIQ to the RF input of R&S Analyzer (coaxial cable with N connectors).

Settings on R&S SMIQ: **[PRESET]**
[LEVEL: 0 dBm]
[FREQ:2.1175 GHz]
 DIGITAL STD
 WCDMA/3GPP
 SET DEFAULT
 LINK DIRECTION UP/REVERSE
 TEST MODELS (NOT STANDARDIZED)...
 C+D960K
 STATE: ON

Settings on R&S Analyzer: **[PRESET]**
[CENTER: 2.1175 GHz]
[AMPT: 0 dBm]
[3G FDD UE]
[MEAS: POWER]

Measurement on The following is displayed:

R&S Analyzer:

- Spectrum of the 3GPP FDD signal

3.3 Measurement 2: Measurement of Spectrum Emission Mask

The 3GPP specification defines a measurement, which monitors the compliance with a spectral mask in a range of at least ± 12.5 MHz about the 3GPP FDD carrier. To assess the power emissions in the specified range, the signal power is measured in the range near the carrier by means of a 30kHz filter, in the ranges far off the carrier by means of a 1MHz filter. The resulting trace is compared to a limit line defined in the 3GPP specification.

Test setup

- ▶ Connect the RF output of R&S SMIQ to the RF input of R&S Analyzer (coaxial cable with N connectors).

Settings on R&S SMIQ: **[PRESET]**
[LEVEL: 0 dBm]
[FREQ: 2.1175 GHz]
DIGITAL STD
WCDMA/3GPP
SET DEFAULT
LINK DIRECTION UP/REVERSE
TEST MODELS (NOT STANDARDIZED)...
C+D960K
STATE: ON

Settings on R&S Analyzer: **[PRESET]**
[CENTER: 2.1175 GHz]
[AMPT: 0 dBm]
[3G FDD UE]
[MEAS: SPECTRUM EM MASK]

Measurement on R&S Analyzer: The following is displayed:

- Spectrum of the 3GPP FDD signal
- Limit line defined in the standard
- Information on limit line violations (passed/failed)

3.4 Measurement 3: Measurement of Relative Code Domain Power

A code domain power measurement on one of the channel configurations is shown in the following. Basic parameters of CDP analysis are changed to demonstrate the effects of non-signal-adapted values.

Settings on R&S SMIQ:

- ▶ Connect the RF output of R&S SMIQ to the input of R&S Analyzer
- ▶ Connect the reference input (EXT REF IN/OUT) on the rear panel of the

analyzer to the reference input (REF) on the rear panel of R&S SMIQ (coaxial cable with BNC connectors).

Settings on R&S SMIQ:

```

[PRESET]
[LEVEL:      0 dBm]
[FREQ:      2.1175 GHz]
DIGITAL STD
  WCDMA 3GPP
    LINK DIRECTION  UP/REVERSE
    TEST MODELS (NOT STANDARDIZED)...
      C+D960K
    SELECT BS/MS
      MS 1 ON
                                OVERALL SYMBOL RATE...6*960
STATE: ON

```

Settings on R&S Analyzer:

```

[PRESET]
[CENTER:    2.1175 GHz]
[AMPT:     10 dBm]
[3G FDD UE]

[SETTINGS:  SCRAMBLING CODE 0]

```

Measurement on R&S Analyzer: The following is displayed:

- Screen A: Code domain power of signal, branch Q (channel configuration with 3 data channels on Q branch)
- Screen B: Numeric results of CDP measurement

3.4.1 Setting: Synchronizing the reference frequencies

The synchronization of the reference oscillators both of the DUT and analyzer strongly reduces the measured frequency error.

Test setup ► Connect the reference input (EXT REF IN/OUT) on the rear panel of the analyzer to the reference output (REF) on the rear panel of R&S SMIQ (coaxial cable with BNC connectors).

Settings on R&S SMIQ: As for measurement 2

Settings on R&S Analyzer: As for measurement 2, plus

```

[SETUP:  REFERENCE EXT]

```

Measurement on R&S Analyzer: Frequency error The displayed frequency error should be < 10 Hz.

The reference frequencies of the analyzer and of the DUT should be synchronized

3.4.2 Setting: Behaviour with Deviating Center Frequency Setting

In the following, the behaviour of the DUT and the analyzer with wrong center frequency setting is shown.

Settings on R&S SMIQ: ► Tune the center frequency of the signal generator in 0.5 kHz steps and watch the analyzer screen:

Measurement on R&S Analyzer:

- A CDP measurement on the analyzer is still possible with a frequency error of up to approx. 1 kHz. Up to 1 kHz, a frequency error causes no apparent difference in measurement accuracy of the code domain power measurement.
- Above a frequency error of 1 kHz, the probability of an impaired synchronization increases. With continuous measurements, at times all channels are displayed in blue with almost the same level.
- Above a frequency error of approx. 2 kHz, a CDP measurement cannot be performed. R&S Analyzer displays all possible codes in blue with a similar level

Settings on R&S SMIQ: ► Set the signal generator center frequency again to 2.1175 GHz:
[FREQ: 2.1175 GHz]

The analyzer center frequency should not differ from the DUT frequency by more than 2 kHz.

3.4.3 Setting: Behaviour with Incorrect Scrambling Code

A valid CDP measurement can only be carried out if the scrambling code set on the analyzer is identical to the one of the transmitted signal.

Settings on R&S SMIQ *SELECT BS/MS*
BS 1: ON
SCRAMBLING CODE: 0001
(the scrambling code is set to 0000 on the analyzer)

Measurement on R&S Analyzer: The CDP display shows all possible codes with approximately the same level.

Settings on R&S Analyzer: Set scrambling code to new value:
[SETTINGS: SCRAMBLING CODE 1]

Measurement on R&S Analyzer: The CDP display again shows the channel configuration.

The scrambling code setting of the analyzer must be identical to that of the measured signal.

3.5 Measurement 4: Triggered Measurement of Relative Code Domain Power

If the code domain power measurement is performed without external triggering, a section of approximately 20 ms of the test signal is recorded at an arbitrary moment to detect the start of a 3GPP FDD frame in this section. Depending on the position of the frame start, the required computing time can be quite long. Applying an external (frame) trigger can reduce the computing time.

Test setup

- ▶ Connect the RF output of R&S SMIQ to the input of R&S Analyzer
- ▶ Connect the reference input (EXT REF IN/OUT) on the rear panel of R&S Analyzer to the reference input (REF) on the rear panel of R&S SMIQ (coaxial cable with BNC connectors).
- ▶ Connect the external trigger input on the rear panel of R&S Analyzer (EXT TRIG GATE) to the external trigger output on the rear panel of R&S SMIQ (TRIGOUT1 of PAR DATA).

Settings on R&S SMIQ: As for measurement 3

Settings on R&S Analyzer: As for measurement 3, plus
[TRIG EXTERN]

Measurement on R&S Analyzer: The following is displayed:

Screen A: Code domain power of signal (channel configuration with 3 data channels on Q branch)

Screen B: Numeric results of CDP measurement

Trg to Frame: Offset between trigger event and start of 3GPP FDD frame

The repetition rate of the measurement increases considerably compared to the repetition rate of a measurement without external trigger.

3.5.1 Setting: Trigger offset

A delay of the trigger event referred to the start of the 3GPP FDD frame can be compensated by modifying the trigger offset.

Settings on R&S Analyzer: [TRIG: TRIGGER OFFSET 100 µS]

Measurement on R&S Analyzer: The parameter Trg to Frame in the numeric results table (screen B) changes:

Trigger to Frame -100 µs

A trigger offset compensates analog delays of the trigger event.

3.6 Measurement 5: Measurement of Composite EVM

The 3GPP specification prescribes the composite EVM measurement as the average square deviation of the total signal:

An ideal reference signal is generated from the demodulated data. The test signal and the reference signal are compared with each other. The square deviation yields the composite EVM.

- Test setup
- ▶ Connect the RF output of R&S SMIQ to the input of R&S Analyzer.
 - ▶ Connect the reference input (EXT REF IN/OUT) on the rear panel of R&S Analyzer to the reference input (REF) on the rear panel of R&S SMIQ (coaxial cable with BNC connectors).
 - ▶ Connect the external trigger input on the rear panel of R&S Analyzer (EXT TRIG GATE) to the external trigger output on the rear panel of R&S SMIQ (TRIGOUT1 of PAR DATA).

Settings on R&S SMIQ:

```
[PRESET]
[LEVEL:           0 dBm]
[FREQ:           2.1175 GHz]
DIGITAL STD
LINK DIRECTION   UP / REVERSE
TEST MODELS (NOT STANDARDIZED)..
C+D960K
SELECT BS/MS
MS 1 ON
OVERALL SYMBOL RATE... 6*960
STATE: ON
```

Settings on R&S Analyzer:

```
[PRESET]
[CENTER:       2.1175 GHz]
[REF:          10 dBm]
[3G FDD UE]
[TRIG          EXTERN]
[RESULTS      COMPOSITE EVM]
```

Measurement on R&S Analyzer:

The following is displayed:

Screen A: Code domain power of signal, branch Q
(channel configuration with 3 data channels on branch Q)

Screen B: Composite EVM (EVM for total signal)

3.7 Measurement 6: Measurement of Peak Code Domain Errors

The peak code domain error measurement is defined in the 3GPP specification for FDD signals.

An ideal reference signal is generated from the demodulated data. The test signal and the reference signal are compared with each other. The difference of the two signals is projected onto the classes of the different spreading factors. The peak code domain error measurement is obtained by summing up the symbols of each difference signal slot and searching for the maximum error code.

- Test setup
- ▶ Connect the RF output of R&S SMIQ to the input of R&S Analyzer
 - ▶ Connect the reference input (EXT REF IN/OUT) on the rear panel of R&S Analyzer to the reference input (REF) on the rear panel of R&S SMIQ (coaxial cable with BNC connectors).
 - ▶ Connect the external trigger input on the rear panel of R&S Analyzer (EXT TRIG GATE) to the external trigger output on the rear panel of R&S SMIQ (TRIGOUT1 of PAR DATA).
- Settings on R&S SMIQ:
- ```
[PRESET]
[LEVEL: 0 dBm]
[FREQ: 2.1175 GHz]
DIGITAL STD
 WCDMA 3GPP
 LINK DIRECTION UP / REVERSE
 TEST MODELS (NOT STANDARDIZED)...
 C+D960K
 SELECT BS/MS
 MS 1 ON
 OVERALL SYMBOL RATE... 6*960
 STATE: ON
```
- Settings on R&S Analyzer:
- ```
PRESET]
[CENTER: 2.1175 GHz]
[REF:    0 dBm]
[3G FDD UE]
[TRIG    EXTERN]
[RESULTS PEAK CODE DOMAIN ERR]
           SPREAD FACTOR 256]
```
- Measurement on R&S Analyzer:
- The following is displayed:
- Screen A: Code domain power of signal, branch Q (channel configuration with 3 data channels on branch Q).
- Screen B: Peak code domain error (projection of the error onto the class with spreading factor 256).

3.8 Measurement 7: Measurement of the Trigger To Frame Time

The trigger to frame (TTF) time measurement yields the time between an external trigger event and the start of the 3GPP WCDMA frame. The result is displayed in the result summary. The trigger event is expected in a time range of one slot (667us) before the frame start. The resolution and absolute accuracy depend on the analyzer type and the measurement mode.

- Test setup:
- ▶ Connect the RF output of R&S SMIQ to the input of R&S Analyzer (coaxial cable with N connectors).
 - ▶ Connect the reference input (EXT REF IN/OUT) on the rear panel of R&S Analyzer to the reference input (REF) on the rear panel of R&S SMIQ (coaxial cable with BNC connectors)
 - ▶ Connect the external trigger input on the rear panel of R&S Analyzer (EXT TRIG GATE) to the external trigger output on the rear panel of R&S SMIQ (TRIGOUT1 of PAR DATA).

Settings on R&S SMIQ:

```
[PRESET]
[LEVEL:           0 dBm]
[FREQ:           2.1175 GHz]
DIGITAL STD
  WCDMA 3GPP
    TEST MODELS ...
      TEST1_32
        STATE: ON
```

Settings on R&S Analyzer:

```
[PRESET]
[CENTER:         2.1175 GHz]
[REF:            0 dBm]
[3G FDD BS]
[TRIG           EXTERN]
[RESULTS       RESULT SUMMARY]
[SCREEN        SCREEN B]
[TRACE:        AVERAGE]
[              CLEAR / WRITE]
[SWEEP COUNT] <numeric value>
```

Measurement on R&S Analyzer: The following is displayed:

Screen A: Code domain power of signal
(Test-Modell 1 mit 32 Kanälen)

Screen B: Result-Summary with Trace-Statistik-Messunge

3.8.1 Resolution of the TTF time measurement

The resolution of the TTF time depends on the analyzer type that is used and the applied trace statistic mode. By using an average mode, the resolution can be increased. The higher the number of sweeps, the higher the resolution at the expense of measurement time. In the average mode, the TTF time is averaged for a number of

sweeps (TRACE→SWEEP COUNT). If the TTF time of the applied signal does not change during for this number of sweeps, the trigger resolution can be improved.

TTF time resolution in dependency of the analyzer type and the statistic mode:

Analyzer	Trace mode	TTF resolution	Number of sweeps
R&S - FSQ	CLEAR/WRITE	< 8 ns	1
R&S - FSQ	AVERAGE	< 0.5 ns	100
R&S - FSU	CLEAR/WRITE	< 65 ns	1
R&S - FSU	AVERAGE	< 4 ns	100
R&S - FSP	CLEAR/WRITE	< 65 ns	1
R&S - FSP	AVERAGE	< 4 ns	100

3.8.2 Absolute accuracy of the TTF time measurement

The absolute accuracy of the TTF time measurement depends on the level of the trigger pulse. The analyzer is calibrated to display the minimum deviation at a trigger pulse level of 4 V. The trigger threshold for an external trigger event is 1.4 V. Due to an internal lowpass between the back panel and the trigger detector, the trigger pulse is delayed in correlation to its own level

The absolute error of the TTF time measurement as a function of the trigger level is as follows:

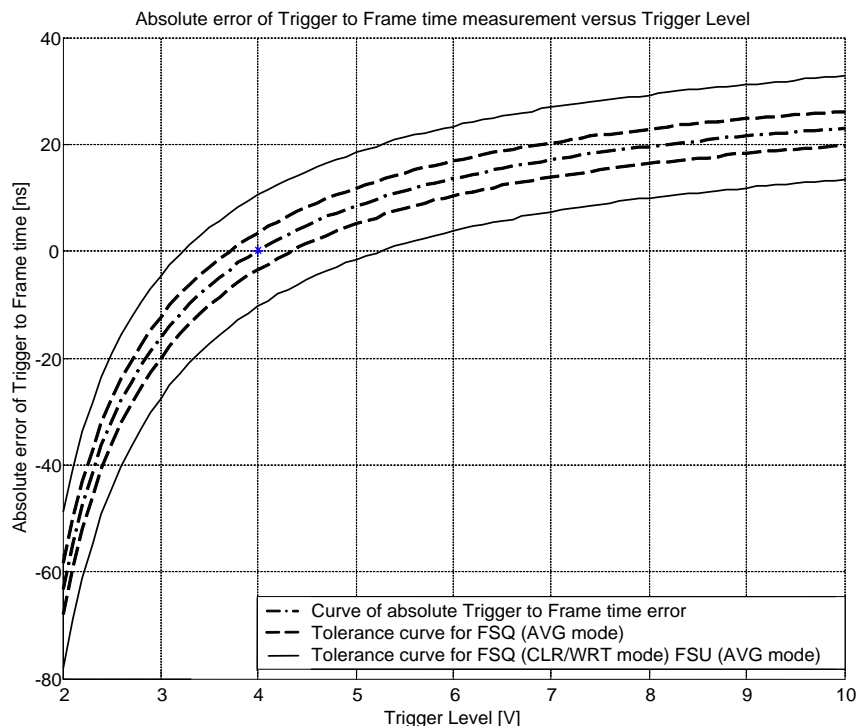

The dash-dotted curve shows the error of the TTF measurement. The dashed and solid curves indicate the expected measurement uncertainty depending on the

analyzer type used and the applied trace statistic. To calculate the accurate TTF time, the error needs to be subtracted from the measured TTF value:

$$T_{TrgToFrame} = T_{Meas_Analyser} - T_{Error}$$

where:

$T_{TrgToFrame}$	correct TTF time
$T_{meas_Analyser}$	TTF time displayed by the analyzer (display RESULT SUMMARY)
T_{error}	absolute error

3.8.3 Trace statistic in the RESULT SUMMARY display

The trace statistic functions can be enabled by selecting SCREEN B. After screen B is selected, the trace menu can be called (press hardkey TRACE). In the trace menu, the kind of trace statistic can be selected.

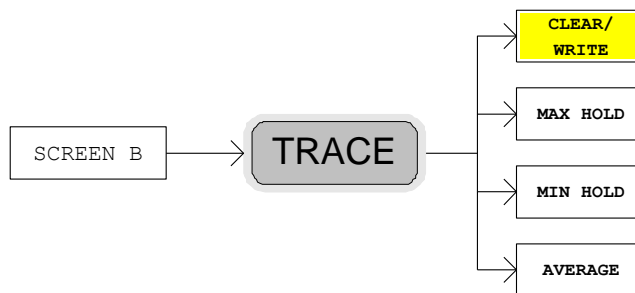

The parameter SWEEP COUNT determines the number of sweeps. The result values in the result summary of screen B are tagged with an abbreviation to indicate which kind of trace statistic is applied to the results. If measured with the trace statistic, the channel table is automatically switched to predefined mode. The last measured channel table is used and stored to "RECENT". In this case, any change in the signal channel configuration does not influence the displayed channel table.

The following trace statistic functions can be applied and are tagged with the corresponding abbreviations shown in the last column:

CLEAR/WRITE:	Displays the result value of the last sweep	(<none>)
MAX HOLD:	Displays the maximum result values of a number of sweeps	(<MAX>)
MIN HOLD:	Displays the minimum result value of a number of sweeps	(<MIN>)
AVERAGE:	Displays the average result value of a number of sweeps	(<AVG>)

4 Setup for User Equipment Tests

NOTICE

Non-compliance with these instructions may cause damage to the instrument.

- Before turning the instrument on, the following conditions must be fulfilled:
- Instrument covers are in place and all fasteners are tightened.
- Fan openings are free from obstructions.
- Signal levels at the input connectors are all below specified maximum values.
- Signal outputs are correctly connected and not overloaded.

This section describes how to set up the analyzer for 3GPP FDD user equipment tests. As a prerequisite for starting the test, the instrument must be correctly set up and connected to the AC power supply as described in chapter 1 of the operating manual for the analyzer. Furthermore, the application firmware module must be properly installed following the instructions given in chapter 1 of the present manual.

4.1.1 Standard Test Setup

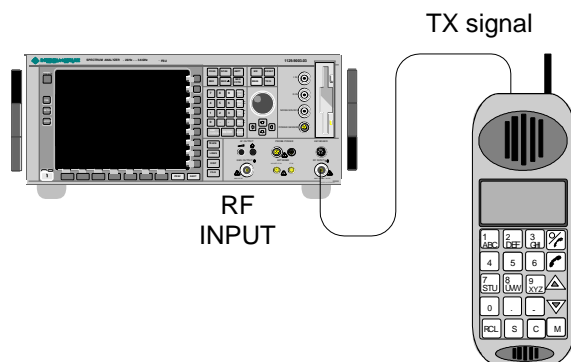

Figure 4-1: UE test setup

- ▶ Connect antenna output (or TX output) of UE to RF input of the analyzer via a power attenuator of suitable attenuation. The following values are recommended for the external attenuator to ensure that the RF input of the analyzer is protected and the sensitivity of the analyzer is not reduced too much:

Max. power	Recommended ext. attenuation
≥ 55 to 60 dBm	35 to 40 dB
≥ 50 to 55 dBm	30 to 35 dB
≥ 45 to 50 dBm	25 to 30 dB
≥ 40 to 45 dBm	20 to 25 dB
≥ 35 to 40 dBm	15 to 20 dB

≥ 30 bis 35 dBm	10 bis 15 dB
≥ 25 bis 30 dBm	5 bis 10 dB
≥ 20 bis 25 dBm	0 bis 5 dB
< 20 dBm	0 dB

- ▶ For signal measurements at the output of two-port networks, connect the reference frequency of the signal source to the rear reference input of the analyzer (*EXT REF IN/OUT*).
To ensure that the error limits specified by the 3GPP standard are met, the analyzer should use an external reference frequency for frequency measurements on user equipments. A rubidium frequency standard may be used for instance as a reference source.
- ▶ If the user equipment is provided with a trigger output, connect this output to the rear trigger input of the analyzer (*EXT TRIG GATE*).

4.1.2 Presetting

- ▶ Enter external attenuation (REF LVL OFFSET).
- ▶ Enter reference level.
- ▶ Enter center frequency.
- ▶ Set the trigger.
- ▶ Select standard and measurement.

5 3GPP FDD Channel Configurations

The possible channel configurations for the mobile station signal are limited by 3GPP. Only two different configurations for data channels DPDCH are permissible according to the specification. In addition to these two channel configurations the transmission of channel HS-DPCCH is permissible for operating the mobile station in mode HSDPA. For this reason, the R&S FS-K73 checks for these channel configurations only during the automatic channel search. Therefore, channels whose parameters do not correspond to one of these configurations are not automatically detected as active channels.

The two possible channel configurations are summarized below:

Table 5-1: Channel configuration 1: DPCCH and 1 DPDCH

Channel type	Number of channels	Symbol rate	Spreading code(s)	Mapping to component
DPCCH	1	15 ksps	0	Q
DPDCH	1	15 ksps – 960 ksps	[Spreading-Faktor / 4]	I

Table 5-2: Channel configuration 2: DPCCH and up to 6 DPDCH

Channel type	Number of channels	Symbol rate	Spreading code(s)	Mapping to component
DPCCH	1	15 ksps	0	Q
DPDCH	1	960 ksps	1	I
DPDCH	1	960 ksps	1	Q
DPDCH	1	960 ksps	3	I
DPDCH	1	960 ksps	3	Q
DPDCH	1	960 ksps	2	I
DPDCH	1	960 ksps	2	Q

Table 5-3: Channel configuration 3: DPCCH, up to 6 DPDCH and 1 HS-DPCCH

In addition to the channel configurations shown above in table 4-2, one HS-DPCCH can be added to each channel table.

Number of DPDCH	Symbol rate all DPDCH	Symbol rate HS-DPCCH	Spreading code HS-DPCCH	Mapping to component (HS-DPCCH)
1	15 – 960 ksps	15 ksps	64	Q
2	1920 ksps	15 ksps	1	I
3	2880 ksps	15 ksps	32	Q
4	3840 ksps	15 ksps	1	I
5	4800 ksps	15 ksps	32	Q
6	5760 ksps	15 ksps	1	I

Table 5-4: Kanalkonfiguration 4: DPCCH, bis zu 1 DPDCH, 1E-DPCCH, bis zu 4 E-DPDCH

The E-DPCCH is always spread with channelisation code 1 at symbol rate 15 ksps. The number of E-DPDCH channels depends on the number of DPDCH channels: If there is no DPDCH configur.ed, the signal can contain up to 4 E-DPDCH channels. If there is one DPDCH configured, only up to 2 E-DPDCH channels are possible.

E-DPDCH_k shall be spread with channelisation code $c_{ed,k}$. The sequence $c_{ed,k}$ depends on $N_{\max\text{-dpdch}}$ and the spreading factor selected for the corresponding frame or sub-frame as specified in [7]; it shall be selected according to table 1E.

Number of DPDCH	E-DPDCH _k	Spreading code E-DPDCH
0	E-DPDCH1	Cch,SF,SF/4 if SF ≥ 4 Cch,2,1 if SF = 2
	E-DPDCH2	Cch,4,1 if SF = 4 Cch,2,1 if SF = 2
	E-DPDCH3 E-DPDCH4	Cch,4,1
1	E-DPDCH1	Cch,SF,SF/2
	E-DPDCH2	Cch,4,2 if SF = 4 Cch,2,1 if SF = 2



When more than one E-DPDCH is transmitted, the respective channelisation codes used for E-DPDCH₁ and E-DPDCH₂ are always the same

6 Menu Overview

Application Firmware Module R&S FS-K73 (3GPP FDD user equipment test) extends the analyzer by the code domain measurement mode for 3GPP FDD standard. Additional softkeys are available which allow overview measurements in the analyzer mode.

The R&S FS-K73 application is started by a click on the 3G FDD UE hotkey:

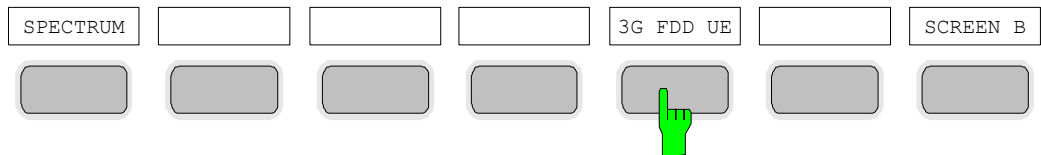

The main settings of the code domain power measurements can be directly selected via the hotkey bar that changes after the application has been started.

When one of the *CHAN CONF*, *SETTINGS*, *RESULTS* hotkeys is selected, the measurement is automatically switched to the Code Domain Power measurement mode.

If the *EXIT 3GPP* hotkey is selected, R&S FS-K73 is exited. The hotkey bar of the basic unit is displayed again.

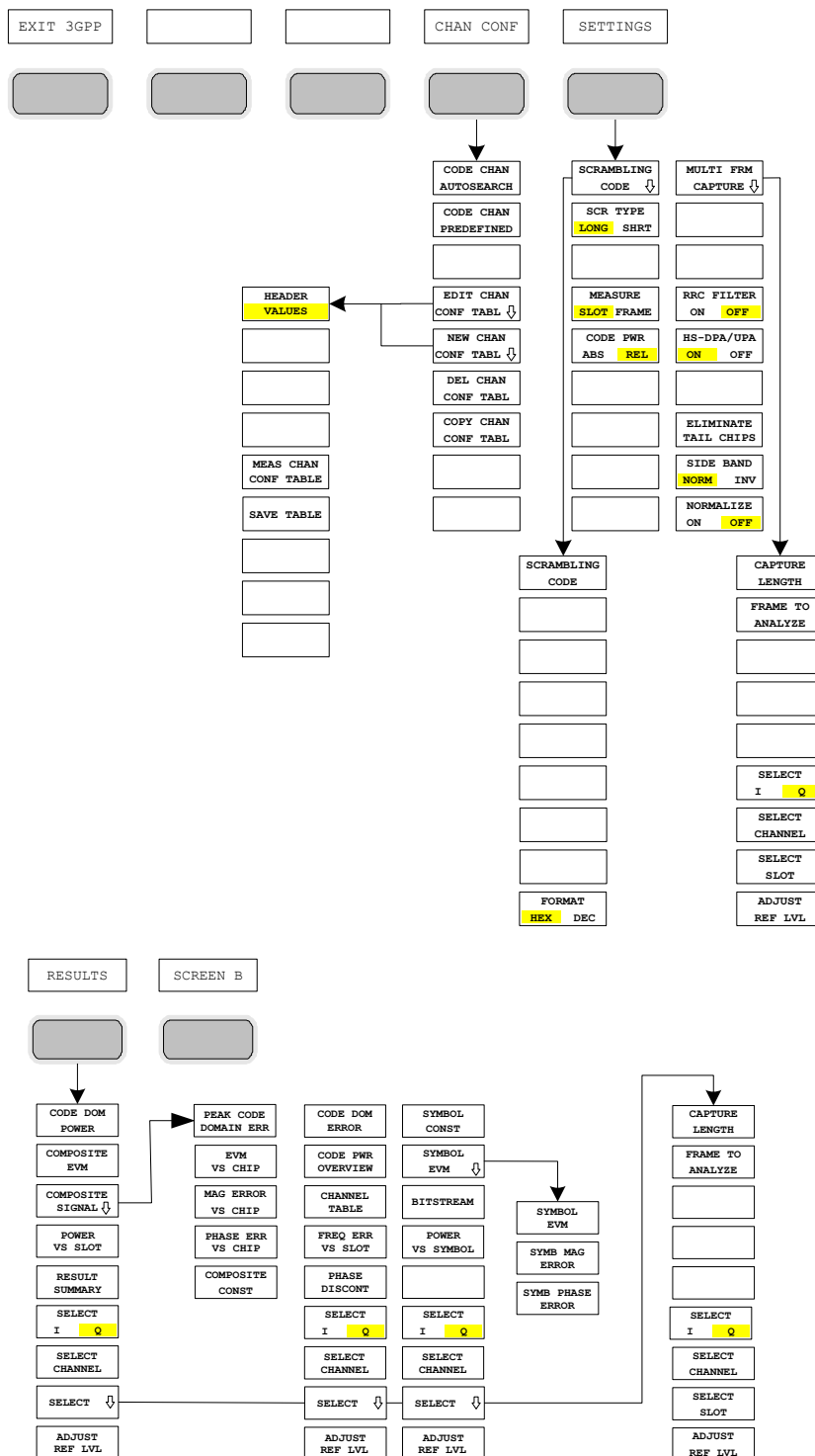

Figure 6-1: Overview of menus of code domain power

The measurements available in R&S FS-K73 can be selected by means of the MEAS key:

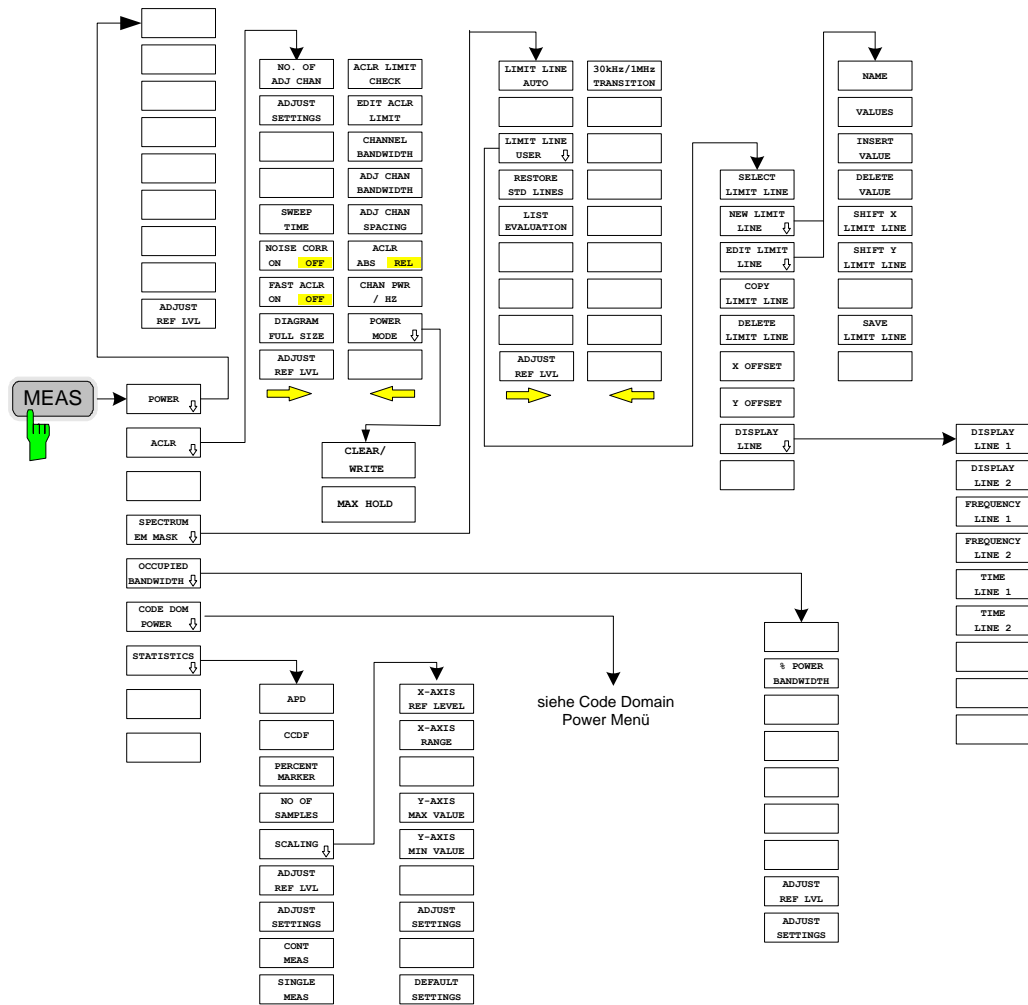

Figure 6-2: Overview of menus

7 Configuration of 3GPP FDD Measurements

The most important parameters for the 3GPP FDD user equipment tests are summarized in the menu of key *MEAS* and are explained below using the softkey functions.

The *CODE DOM POWER* softkey activates the code domain measurement mode and opens the submenus for setting the measurement. A change of the hotkey labels after the application has been started ensures that the most important parameters of the CDP (code domain power) measurements are directly accessible via the hotkey bar.

The softkeys *POWER*, *ACLR*, *SPECTRUM EM MASK*, *OCCUPIED BANDWIDTH* and *STATISTICS* activate user equipment tests in the analyzer or vector analyzer mode. Pressing the associated softkey performs the settings required by 3GPP specifications. A subsequent modification of settings is possible.

The other menus of the spectrum analyzer correspond to the menus of these modes and are described in the operating manual of the main unit.

Key *MEAS*

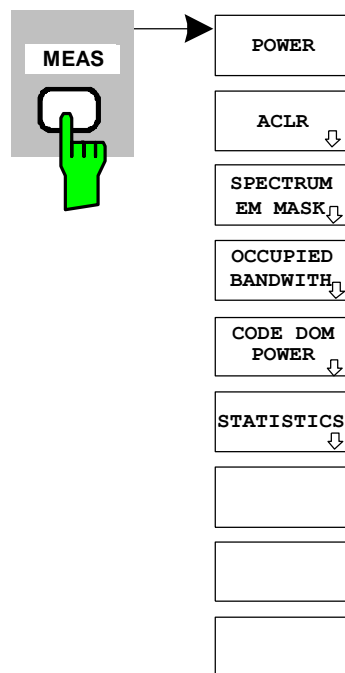

The *MEAS* key opens a submenu for setting the various measurement modes of option R&S FS-K73:

- *POWER* activates the channel power measurement with defined settings in the analyzer mode.
- *ACLR* activates the adjacent channel power measurement with defined settings in the analyzer mode.
- *SPECTRUM EM MASK* compares the signal power in different carrier offset ranges with the maximum values specified by 3GPP.

- OCCUPIED BANDWIDTH activates the measurement of the occupied bandwidth (analyzer mode).
- CODE DOM POWER activates the code domain measurement mode and opens another submenu for selecting and configuring the parameters. All other menus of the spectrum analyzer are adapted to the functions of the code domain measurement mode.
- STATISTICS evaluates the signal with regard to its statistical characteristics (distribution function of the signal amplitudes).

7.1 Measurement of Channel Power

POWER

The POWER softkey activates measurement of the 3GPP FDD signal channel power.

The R&S Analyzer measures the unweighted RF signal power in a bandwidth of.

$$f_{BW} = 5\text{ MHz} \geq (1 + \alpha) \cdot 3.84\text{ MHz} \approx 4.7\text{ MHz} \quad | \quad \alpha = 0.22$$

The power is measured in zero span mode using a digital channel filter of 5 MHz in bandwidth. According to the 3GPP standard, the measurement bandwidth (5 MHz) is slightly larger than the minimum required bandwidth of 4.7 MHz. The bandwidth is displayed numerically below the screen.

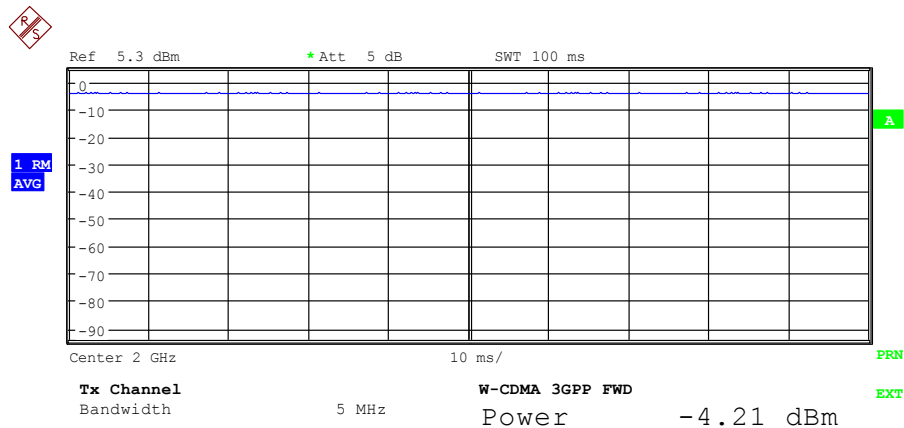

Figure 7-1: Power measurement in the 3.84 MHz transmission channel using a 5 MHz channel filter

Pressing the softkey activates the analyzer mode with defined settings:

SYSTEM PRESET		
After PRESET the following user-specific settings are restored and so the adaptation to the DUT is maintained:		
Reference Level + Rev Level Offset		
Center Frequency + Frequency Offset		
Input Attenuation		
Mixer Level		
All trigger settings		
CHAN PWR / ACP	CP / ACP ON	

CP / ACP STANDARD	W-CDMA 3GPP REV	
CP / ACP CONFIG	NO. OF ADJ CHAN	0

Starting from these settings, the instrument can be operated in all functions available in the analyzer mode, i.e. all test parameters can be adapted to the requirements of the specific measurement.

Remote: CONF:WCDP:MEAS POW

Query of results: CALC:MARK:FUNC:POW:RES? CPOW

7.2 Measurement of Adjacent-Channel Power - ACLR

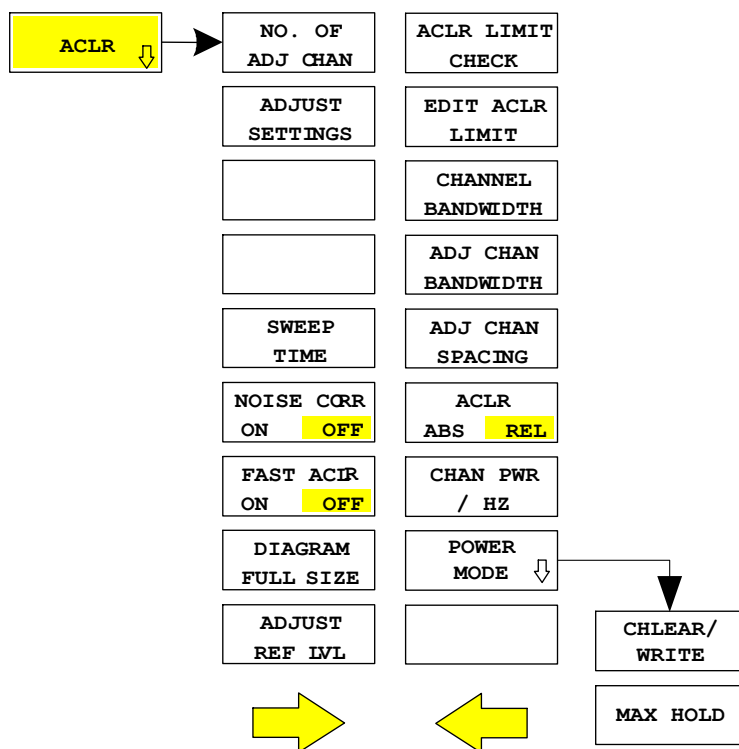

The *ACLR* softkey activates the adjacent-channel power measurement in the default setting according to 3GPP specifications (Adjacent Channel Leakage Power Ratio).

The instrument measures the channel power and the relative power of adjacent channels and of the next channels. The results are displayed below the screen

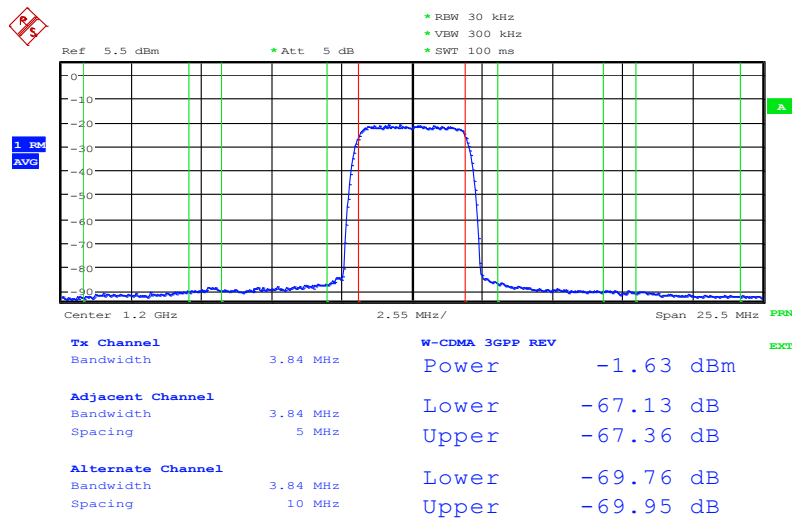

Figure 7-2: Adjacent-channel power measurement of a 3GPP FDD user equipment

Pressing the softkey activates the analyzer mode with defined settings:

SYSTEM PRESET		
After PRESET the following user-specific settings are restored and so the adaptation to the DUT is maintained:		
Reference Level + Rev Level Offset Center Frequency + Frequency Offset Input Attenuation Mixer Level All trigger settings		
CHAN PWR / ACP	CP / ACP ON	
CP / ACP STANDARD	W-CDMA 3GPP REV	
CP / ACP CONFIG	NO. OF ADJ CHAN	2

Starting from these settings, the instrument can be operated in all functions available in the analyzer mode, i.e. all test parameters can be adapted to the requirements of the specific measurement.

Remote: CONF:WCDP:MEAS ALCR

Query of results: CALC1:MARK:FUNC:POW:RES? ACP

NO. OF ADJ CHAN

The *NO. OF ADJ CHAN* softkey activates the entry of the number $\pm n$ of adjacent channels to be considered in the adjacent-channel power measurement.

Numbers from 0 to 12 can be entered.

The following measurements are performed depending on the number of the channels.

- 0 Only the channel power is measured.
- 1 The channel power and the power of the upper and lower adjacent channel are measured.
- 2 The channels power, the power of the upper and lower adjacent channel and of the next higher and lower channel (alternate channel 1) are measured.

- 3 The channel power, the power of the upper and lower adjacent channel, the power of the next higher and lower channel (alternate channel 1) and of the next but one higher and lower adjacent channel (alternate channel 2) are measured.

With higher numbers the procedure is expanded accordingly.

Remote: SENS:POW:ACH:ACP 2

Result: SENS:POW:ACH:ACP?

This increased number of adjacent channels is implemented through all the relevant settings such as:

ACLR LIMIT CHECK

CALC:LIM:ACP:ACH:RES?

CALC:LIM:ACP:ALT1..11:RES?

EDIT ACLR LIMITS

CALC:LIM:ACP:ACH:STAT ON

CALC:LIM:ACP:ACH:ABS -10dBm, -10dBm

CALC:LIM:ACP:ACH:ABS:STAT ON

CALC:LIM:ACP:ALT1..11 0dB, 0dB

CALC:LIM:ACP:ALT1..11:STAT ON

CALC:LIM:ACP:ALT1..11:ABS -10dBm, -10dBm

CALC:LIM:ACP:ALT1..11:ABS:STAT ON

ADJ CHAN BANDWIDTH

SENS:POW:ACH:BWID:ALT1..11 30kHz

ADJ CHAN SPACING

SENS:POW:ACH:SPAC:ALT1..11 4MHz

ADJUST SETTINGS

The *ADJUST SETTINGS* softkey automatically optimizes analyzer settings for the selected power measurement (see below).

All analyzer settings relevant for power measurements within a specific frequency range (channel bandwidth) are optimally set depending on the channel configuration (channel bandwidth, channel spacing):

- Frequency span:
The frequency span must cover at least all the channels that are to be considered. When the channel power is measured, the span is set to twice the channel bandwidth.
The setting of the span for adjacent-channel power measurements depends on the channel spacing and the channel bandwidth of the adjacent channel with the largest distance from the transmission channel, ADJ, ALT1 or ALT2 .
- Resolution bandwidth $RBW \leq 1/40$ of channel bandwidth
- Video bandwidth $VBW \geq 3 \times RBW$
- Detector RMS detectorr

The trace math and trace averaging functions are switched off.

The reference level is not influenced by *ADJUST SETTINGS*. It can be separately adjusted with *ADJUST REF LVL*.

The adjustment is only carried out once; if necessary, the instrument settings can be changed later.

Remote: SENS:POW:ACH:PRES ACP|CPOW|OBW

SWEEP TIME

The *SWEEP TIME* softkey activates entry of the sweep time. When the RMS detector is used, a longer sweep time yields more stable results.

This setting is identical with the *SWEEP TIME MANUAL* setting in the *BW* menu.

Remote: SENS:SWE:TIM <value>

NOISE CORR ON / OFF

The *NOISE CORR ON/OFF* softkey switches on correction of measurement results due to the residual instrument noise. When the softkey is switched on, the first step is to measure the residual instrument noise. The measured noise is then deducted from the power in the observed channel.

Each time the measurement frequency, the resolution bandwidth, the measurement time or the level settings are changed, noise correction is switched off. To repeat the residual noise measurement with the new settings, the softkey must be pressed again

Remote: SENS:POW:NCOR ON

FAST ACLR ON / OFF

The *FAST ACLR* softkey toggles between measurement in line with the IBW method (*FAST ACLR OFF*) and measurement in the time domain (*FAST ACLR ON*).

With *FAST ACLR ON* selected, the power is measured in the various channels in the time domain. The R&S Analyzer sets its center frequency to the different channel center frequencies one after the other, and then measures the power at these frequencies with the set measurement time (= sweep time/number of measured channels). Suitable RBW filters are automatically used for the selected standard and frequency offset (root raised cosine at WCDMA).

The RMS detector is used for correct power measurement. Software correction factors are not required in this case.

Measured values are output in the form of a table; the power of the useful channel is specified in dBm and the power of the adjacent channels in dBm (*ACLR ABS*) or dB (*ACLR REL*).

The selected sweep time (= measurement time) depends on the desired reproducibility of measurement results. The longer the selected sweep time, the better the reproducibility of results, because, in this case, the power is measured over a longer period of time.

As a rule of thumb, it can be assumed that approx. 500 uncorrelated values are required for a reproducibility value of 0.5 dB (99% of the measurement is within 0.5 dB of the true measured value). Measured values are considered uncorrelated if their time spacing corresponds to the reciprocal of the measurement bandwidth.

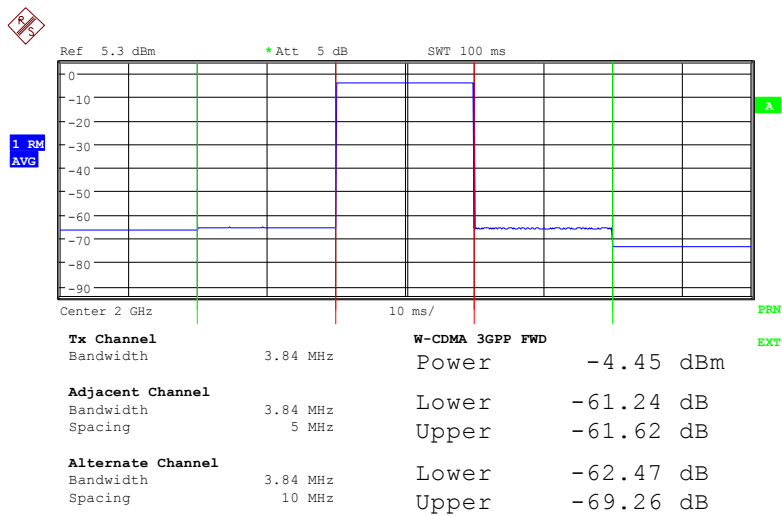

Remote: SENS:POW:HSP ON

DIAGRAM FULL SIZE

The *DIAGRAM FULL SIZE* softkey switches the diagram to full screen size.

Remote: -

ADJUST REF LVL

The *ADJUST REF LVL* softkey adapts the reference level of the R&S Analyzer to the measured channel power. This ensures that the settings for RF attenuation and reference level are optimally adapted to the signal level so that the R&S Analyzer is not overdriven or that the dynamic range is not reduced by an S/N ratio that is too low.

Since the measurement bandwidth for adjacent-channel power measurements is clearly narrower than the signal bandwidth, the signal path can be overdriven although the measured trace is definitely below the reference level.

Remote: SENS:POW:ACH:PRES:RLEV

ACLR LIMIT CHECK

The *ACLR LIMIT CHECK* softkey switches limit check for the ACLR measurement on or off.

Remote: CALC:LIM:ACP ON

Query of LIMIT CHECK results for

Adjacent Ch: CALC:LIM:ACP:ACH:RES?

Alternate Ch<1..2>: CALC:LIM:ACP:ALT<1..2>:RES?

Result Format:

Left Sideband [PASSED, FAILED]

Right Sideband [PASSED, FAILED]

EDIT ACLR LIMIT

EDIT ACLR LIMIT opens a table with limits for the ACLR measurement. The standard-specific default values are entered with the *ADJUST SETTINGS* softkey.

ACP LIMITS				
CHAN	RELATIVE LIMIT CHECK		ABSOLUTE LIMIT CHECK	
	VALUE	ON	VALUE	ON
ADJ	-55 dBc	√	0 dBm	
ALT1	-70 dBc	√	0 dBm	
ALT2	0 dBc		0 dBm	

The following rules apply for limit values:

- A limit value can be defined for each of the adjacent channels. The limit value applies to the upper and the lower adjacent channel.
- A relative limit value and/or an absolute limit can be defined. The check can be activated separately for the two limit values.
- Compliance with active limit values is checked irrespective of whether absolute or relative limits are specified or whether the measurement itself is performed with absolute levels or a relative level ratio. If the two checks are active and the higher one of the two levels is exceeded, the respective value will be marked.

Note:

Measured values violating the limit are printed in red and preceded by a red asterisk.

```
Remote:  CALC:LIM:ACP ON
         CALC:LIM:ACP:ACH 0dB,0dB
         CALC:LIM:ACP:ACH:STAT ON
         CALC:LIM:ACP:ACH:ABS -10dBm,-10dBm
         CALC:LIM:ACP:ACH:ABS:STAT ON
         CALC:LIM:ACP:ALT1 0dB,0dB
         CALC:LIM:ACP:ALT1:STAT ON
         CALC:LIM:ACP:ALT1:ABS -10dBm,-10dBm
         CALC:LIM:ACP:ALT1:ABS:STAT ON
         CALC:LIM:ACP:ALT2 0dB,0dB
         CALC:LIM:ACP:ALT2:STAT ON
         CALC:LIM:ACP:ALT2:ABS -10dBm,-10dBm
         CALC:LIM:ACP:ALT2:ABS:STAT ON
```

CHANNEL BANDWIDTH

The *CHANNEL BANDWIDTH* softkey activates the entry of the channel bandwidth for the transmission channel.

The useful channel bandwidth is generally defined by the transmission method. In the WCDMA default setting, measurements are performed with a channel bandwidth of 3.84 MHz.

When measuring according to the IBW method (*FAST ACP OFF*), the channel bandwidth is marked by two vertical lines to the left and right of the screen center. It can thus be visually checked whether the entire power of the signal to be measured is within the selected channel bandwidth.

With the time domain method (*FAST ACP ON*), the measurement is performed in zero span. The channel limits are not marked in this case. The R&S Analyzer offers all available channel filters for selecting the channel bandwidth. Deviating channel bandwidths cannot be set. If deviating channel bandwidths are required, the IBW method should be used

```
Remote:  SENS:POW:ACH:BWID 3.84MHz
```

ADJ CHAN BANDWIDTH

The *ADJ CHAN BANDWIDTH* softkey opens a table where the channel bandwidths for the adjacent channels can be defined.

ACP CHANNEL BW	
CHAN	BANDWIDTH
ADJ	3.84 MHz
ALT1	3.84 MHz
ALT2	3.84 MHz

When measuring according to the IBW method (FAST ACP OFF), the bandwidths of the different adjacent channels are to be entered numerically. Since all adjacent channels often have the same bandwidth, the other channels ALT1 and ALT2 are set to the bandwidth of the adjacent channel on entering the adjacent-channel bandwidth (ADJ). Thus only one value needs to be entered in case of equal adjacent channel bandwidths. The same holds true for the ALT2 channels (alternate channels 2) when the bandwidth of the ALT1 channel (alternate channel 1) is entered.

Note:

The bandwidths can be selected independently from each other by overwriting the table from top to bottom.

With the time domain method (FAST ACP ON), the adjacent-channel bandwidths are selected from the list of available channel filters. For deviating adjacent-channel bandwidths, the IBW method should be used.

```
Remote:  SENS:POW:ACH:BWID:ACH 3.84MHz
         SENS:POW:ACH:BWID:ALT1 3.84MHz
         SENS:POW:ACH:BWID:ALT2 3.84MHz
```

**ADJ CHAN
SPACING**

The *ADJ CHAN SPACING* softkey opens a table for defining the channel spacings.

ACP CHANNEL SPACING	
CHAN	SPACING
ADJ	5 MHz
ALT1	10 MHz
ALT2	15 MHz

Since all adjacent channels often have the same distance to each other, the entry of the adjacent-channel spacing (ADJ) causes channel spacing ALT1 to be set to twice and channel spacing ALT2 to three times the adjacent-channel spacing. Thus only one value needs to be entered in case of equal channel spacing. The same holds true for the ALT2 channels when the bandwidth of the ALT1 channel is entered.

Note

The channel spacings can be set separately by overwriting the table from top to bottom.

```
Remote:  SENS:POW:ACH:SPAC:ACH 5MHz
         SENS:POW:ACH:SPAC:ALT1 10MHz
         SENS:POW:ACH:SPAC:ALT2 15MHz
```

**ACLR
ABS / REL**

The *ACLR ABS / REL* softkey (channel power absolute/relative) switches between absolute and relative power measurement in the channel.

ACLR ABS The absolute power in the transmission channel and in the adjacent channels is displayed in the unit of the y-axis, e.g. in dBm.

ACLR REL In case of adjacent-channel power measurements (*NO. OF ADJ CHAN* > 0), the level of the adjacent channels is displayed relative to the level

of the transmission channel in dBc.

With linear scaling of the y-axis, the power of the new channel is displayed relative to the reference channel (CP/CP_{ref}). With dB scaling, the logarithmic ratio $10\lg(CP/CP_{ref})$ is displayed.

Relative channel power measurement can thus also be used for universal adjacent-channel power measurements. Each channel can be measured individually.

Remote: SENS:POW:ACH:MODE ABS

CHAN PWR / HZ

The *CHAN PWR / HZ* softkey switches between the measurement of the total power in the channel and the power measurement with reference to 1 Hz bandwidth.

The conversion factor is $10 \cdot \lg \frac{1}{\text{Channel} \cdot \text{Bandwidth}}$.

Remote: CALC:MARK:FUNC:POW:RES:PHZ ON|OFF

For manual setting of the test parameters different from the settings made with *ADJUST SETTINGS* the following should be observed:

Frequency span The frequency span has to cover at least all channels to be measured.

For channel power measurement this is the channel bandwidth.

If the frequency span is large compared to the frequency section (or frequency sections) under test, only a few pixels are available to be measured.

Resolution bandwidth (RBW)

To ensure both an acceptable measurement speed and the required selection (to suppress spectral components outside the channel to be measured, especially of the adjacent channels), the resolution bandwidth must not be selected too small or too large. As a general approach, the resolution bandwidth is to be set to values between 1% and 4% of the channel bandwidth. A larger resolution bandwidth can be selected if the spectrum within the channel to be measured and around it has a flat characteristic

Video bandwidth (VBW)

For a correct power measurement, the video signal must not be limited in bandwidth. A restricted bandwidth of the logarithmic video signal would cause signal averaging and thus result in a too low indication of the power (-2.51 dB at very low video bandwidths). The video bandwidth should therefore be selected at least three times the resolution bandwidth.

The *ADJUST SETTINGS* softkey sets the video bandwidth (VBW) as a function of the channel bandwidth as follows:

Detektor

$$VBW \geq 3 \times RBW.$$

The *ADJUST SETTINGS* softkey selects the RMS detector.

The RMS detector is selected since it correctly indicates the power irrespective of the characteristics of the signal to be measured. In principle, the sample detector would be possible as well. Due to the limited number of trace pixels used to calculate the power in the channel, the sample detector would yield less stable results.

Averaging, which is often performed to stabilize the measurement results, leads to a too low-level indication and should therefore be avoided. The reduction in the displayed power depends on the number of averages and the signal characteristics in the channel to be measured.

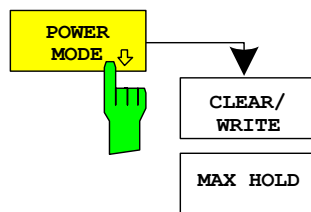

The *POWER MODE* submenu allows you to change between the normal (*CLEAR/WRITE*) and the *MAX HOLD* power mode. In the *CLEAR/WRITE* mode the channel power and the adjacent channel powers are calculated directly from the current trace. In *MAX HOLD* mode, the power values are still derived from the current trace, but they are compared with a maximum algorithm to the previous power value. The greater value is retained.

Remote: `CALC:MARK:FUNC:POW:MODE WRIT|MAXH`

7.3 Signal Power Check – SPECTRUM EM MASK

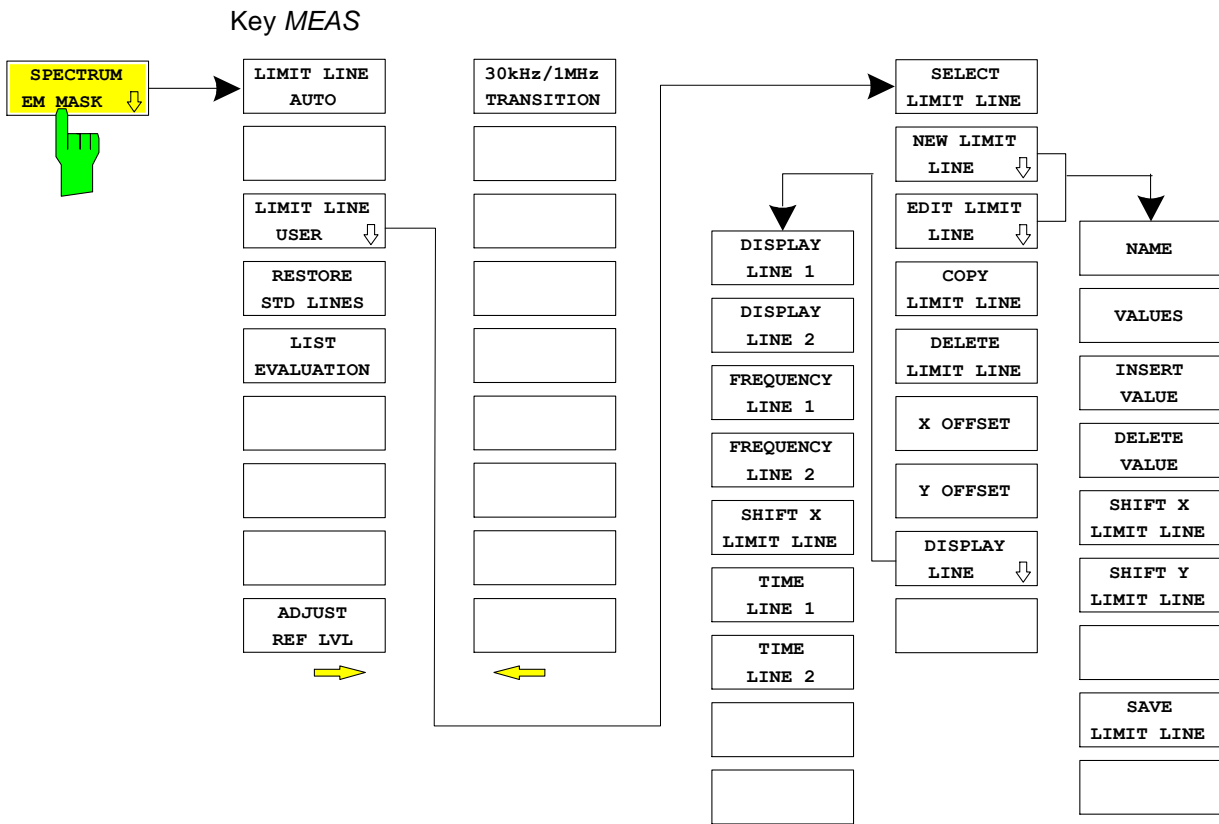

The *SPECTRUM EM MASK* softkey starts the determination of the power of the 3GPP FDD signal in defined offsets from the carrier and compares the power values with a spectral mask specified by 3GPP.

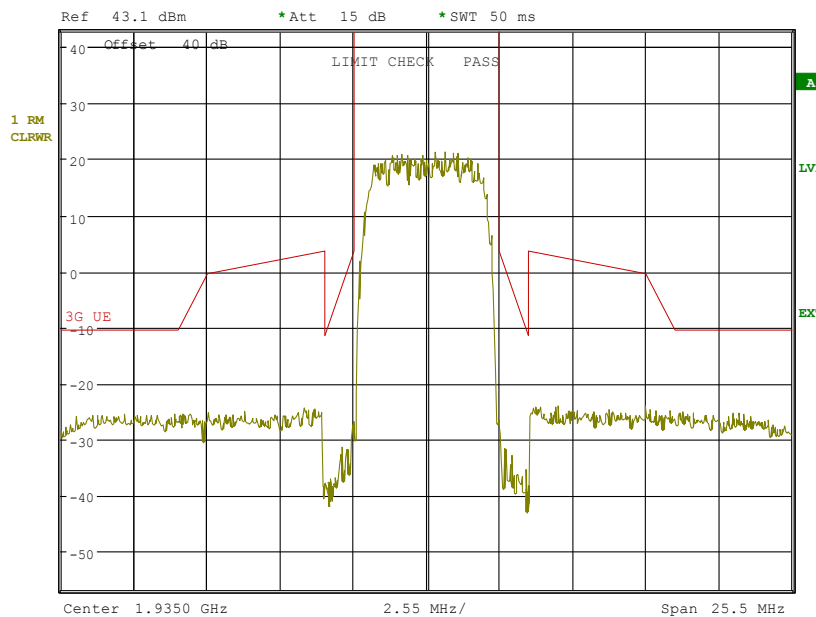

Figure 7-3: Measurement of Spectrum Emission Mask

Pressing the softkey activates the analyzer mode with defined settings:

SYSTEM PRESET		
After PRESET the following user-specific settings are restored and so the adaptation to the DUT is maintained:		
Reference Level + Rev Level Offset Center Frequency + Frequency Offset Input Attenuation + Mixer Level All trigger settings		
CHAN PWR / ACP	CP / ACP ON	
CP / ACP STANDARD	W-CDMA 3GPP REV	
CP / ACP CONFIG	NO. OF ADJ CHAN	0
SPAN		25.5 MHz
BW	SWEEP TIME MANUAL	50 ms

Remote: CONF:WCDP:MEAS ESP

Query of results: CALC:LIMit:FAIL? und visuelle Auswertung

LIMIT LINE AUTO

The *LIMIT LINE AUTO* softkey automatically calculates the limit line according to power determined in the useful channel. If the measurement is carried out in *CONTINUOUS SWEEP* and the channel power changes from sweep to sweep, this can result in the limit line being continuously redrawn.

The softkey is activated when the spectrum emission mask measurement is entered.

Remote: CALC:LIM:ESP:MODE AUTO

The *LIMIT LINE USER* softkey activates the input of user-defined limit lines. The softkey opens the menus of the limit line editor that are known from the basic unit.

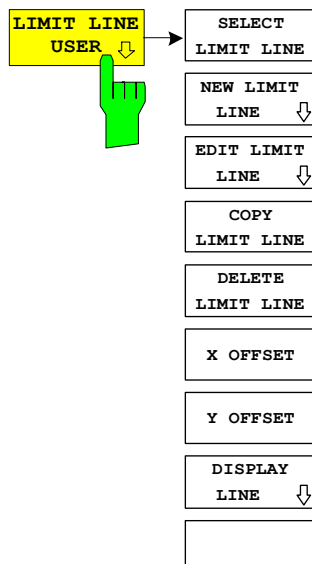

The following limit line settings are useful for user equipment tests:

Trace 1, Domain Frequency, X-Scaling relative, Y-Scaling absolute, Spacing linear, Unit dBm.

In contrast to the predefined limit lines supplied with the analyzer which correspond to the standard specifications, the user-defined limit line can be specified for the entire

frequency range (± 12.5 MHz from carrier) either relatively (referred to the channel power) or absolutely.

Remote: see Table of Softkeys with Assignment of IEC/IEEE Commands

RESTORE STD LINES

The *RESTORE STD LINES* softkey restores the limit lines defined in the standard to the state they were in when the unit was delivered. This prevents inadvertent overwriting of the standard lines.

Remote: `CALC:LIM:ESP:REST`

LIST EVALUATION

The softkey *LIST EVALUATION* reconfigures the SEM output to a split screen. In the upper half the trace with the limit line is shown. In the lower half the peak value list is shown. For every range of the spectrum emission defined by the standard the peak value is listed. For every peak value the frequency, the absolute power, the relative power to the channel power and the delta limit to the limit line is shown. As long as the delta limit is negative, the peak value is below the limit line. A positive delta indicates a failed value. The results are then colored in red, and a star is indicated at the end of the row, for indicating the fail on a black and white printout.

If the list evaluation is active, the peak list function is not available

Remote: `CALC1:PEAK:AUTO ON | OFF`

With this command the list evaluation which is by default for backwards compatibility reasons off can be turned on.

ADJUST REF LVL

The *ADJUST REF LVL* softkey adjusts the analyzer reference level to the total signal power measured.

The softkey becomes active after the first sweep has been terminated with the measurement of the occupied bandwidth and the total signal power is known. The adjustment of the reference level ensures that the instrument signal path is not overdriven and that the dynamic range is not limited by a reference level that is too low.

Remote: `SENS:POW:ACH:PRES:RLEV`

30kHz/1MHz TRANSITION

The *30kHz/1MHz TRANSITION* softkey specifies the offset frequency at which the resolution bandwidth is changed between 30 kHz and 1 MHz.

The default value is 3.5 MHz.

Remote: `CALC2:LIM:ESP:TRAN 3 MHz`

7.4 Measurement of Occupied Bandwidth - OCCUPIED BANDWIDTH

Key *MEAS*

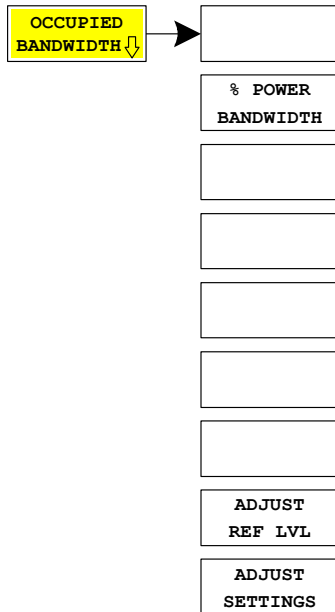

The *OCCUPIED BANDWIDTH* activates the measurement of the bandwidth of the signal

The occupied bandwidth is defined as the bandwidth in which 99% of the total transmitter power is contained. The percentage of the signal power to be included in the bandwidth measurement can be changed.

The occupied bandwidth and the frequency markers are output in the marker info field at the top right edge of the screen.

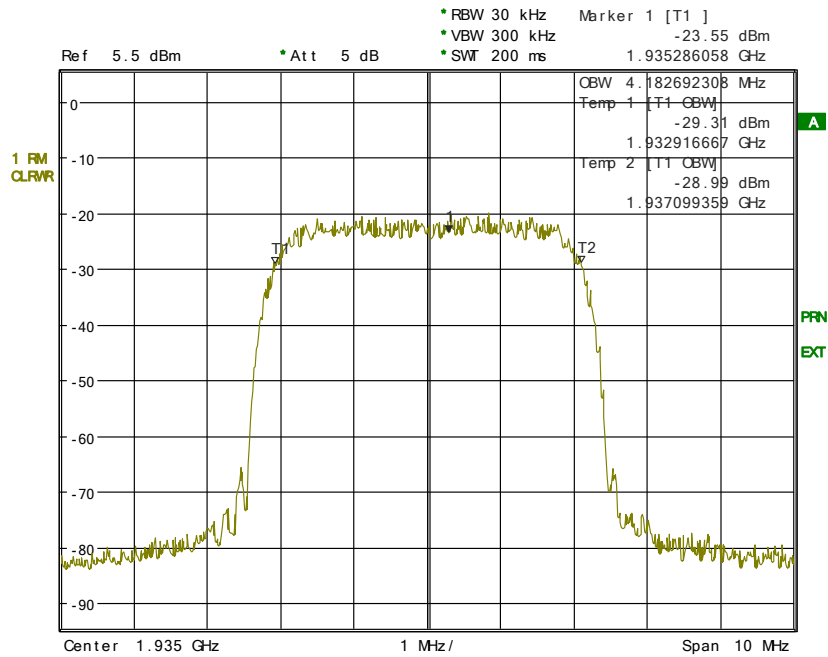

Figure 7-4: Measurement of occupied bandwidth

Pressing the softkey activates the analyzer mode with defined settings:

SYSTEM PRESET		
After PRESET the following user-specific settings are restored and so the adaptation to the DUT is maintained:		
Reference Level + Rev Level Offset Center Frequency + Frequency Offset Input Attenuation + Mixer Level All trigger settings		
OCCUPIED BANDWIDTH		
TRACE 1	DETECTOR	RMS

Remote: CONF:WCDP:MEAS OBAND

Query of results: CALC:MARK:FUNC:POWer:RES? OBAN

% POWER BANDWIDTH

The **% POWER BANDWIDTH** softkey opens the entry of the percentage of power related to the total power in the displayed frequency range which defines the occupied bandwidth (percentage of total power).

The valid range of values is 10% to 99.9%.

Remote: SENS:POW:BWID 99PCT

ADJUST REF LVL

The **ADJUST REF LVL** softkey adjusts the reference level of the analyzer to the measured channel power. This ensures that the settings of the RF attenuation and the reference level are optimally adjusted to the signal level without overloading the instrument or limiting the dynamic range by a too small S/N ratio.

Since the measurement bandwidth for channel power measurements is significantly lower than the signal bandwidth, the signal path may be overloaded although the

trace is still significantly below the reference level.

Remote: SENS:POW:ACH:PRES:RLEV

ADJUST SETTINGS

The *ADJUST SETTINGS* softkey automatically optimizes the instrument settings for the selected power measurement (see below).

All instrument settings relevant for a power measurement within a specific frequency range (channel bandwidth) are optimized for the selected channel configuration (channel bandwidth, channel spacing):

- Frequency span The frequency span has to cover at least all channels to be considered.
When measuring the channel power, 2 x channel bandwidth is set as span.
The setting of the span during adjacent-channel power measurement is dependent on the channel spacing and channel bandwidth of the adjacent channel ADJ, ALT1 or ALT2 with the largest distance from the transmission channel.
- Resolution bandwidth $RBW \leq 1/40$ of channel bandwidth.
- Video bandwidth $VBW \geq 3 \times RBW$.
- Detector RMS detector

Trace math and trace averaging functions are switched off. The reference level is not influenced by *ADJUST SETTINGS*. It can be separately adjusted with *ADJUST REF LVL*.

The adjustment is carried out only once; if necessary, the instrument settings can be changed later.

Remote: SENS:POW:PRES:OBW

7.4.1 Measurement of Signal Statistics

Key *MEAS*

The *STATISTICS* softkey starts a measurement of the distribution function of the signal amplitudes (complementary cumulative distribution function). The measurement can be switched to amplitude power distribution (APD) by means of the menu softkeys.

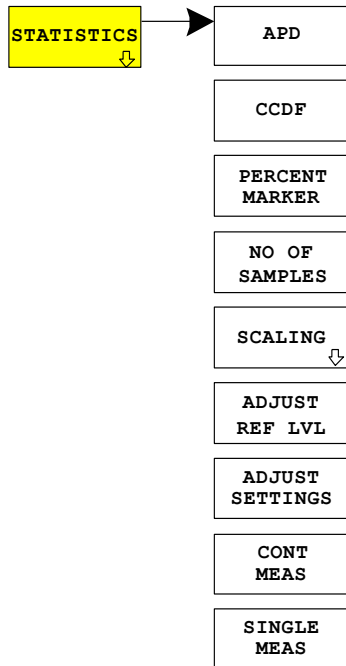

For the purposes of this measurement, a signal section of settable length is recorded continuously in the zero span, and the distribution of the signal amplitudes is evaluated. The record length and display range of the CCDF can be set using the softkeys of the menu. The amplitude distribution is displayed logarithmically as a percentage of the amount by which a particular level is exceeded, beginning with the average value of the signal amplitudes.

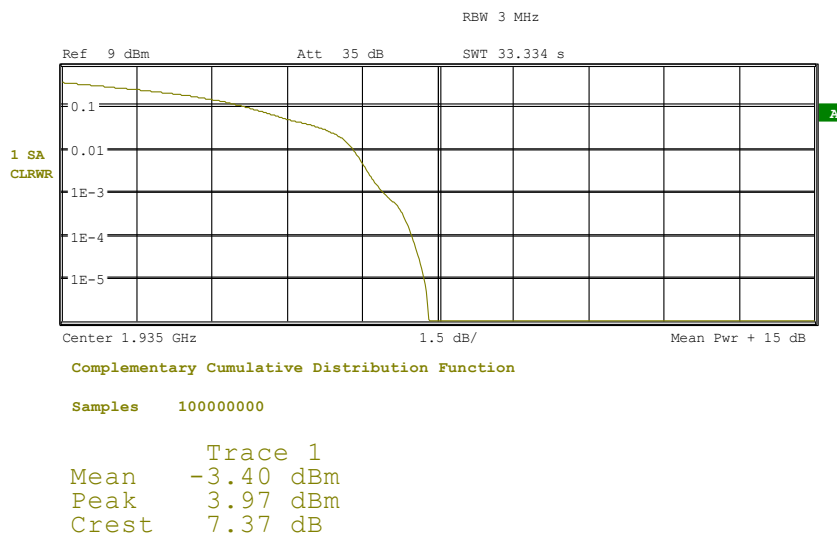

Figure 7-5: CCDF des 3GPP-FDD-Signals.

Pressing the softkey activates the analyzer mode with defined settings:

SYSTEM PRESET		
After PRESET the following user-specific settings are restored and so the adaptation to the DUT is maintained:		
Reference Level + Rev Level Offset		
Center Frequency + Frequency Offset		
Input Attenuation		
Mixer Level		
All trigger settings		
SIGNAL STATISTIC		
TRACE1	DETECTOR	SAMPLE
BW	RES BW MANUAL	10 MHz
	VIDEO BW MANUAL	5 MHz

Starting from these settings, the instrument can be operated in all functions available in the analyzer mode, i.e. all test parameters can be adapted to the requirements of the specific measurement.

```
Remote: CONF:WCDP:MEAS CCDF
        or
        CALC:STAT:CCDF ON
Query of results: CALC:MARK:X?
```

APD The *APD ON/OFF* softkey switches on the amplitude probability distribution function.

When the APD function is switched on, the CCDF function is switched off automatically.

```
Remote: CALC:STAT:APD ON
```

CCDF The *CCDF ON/OFF* softkey switches on the complementary cumulative distribution function.

When the CCDF function is switched on, the APD function is switched off automatically.

```
Remote: CALC:STAT:CCDF ON
```

PERCENT MARKER If the CCDF function is active, the *PERCENT MARKER* softkey allows to position marker 1 by entering a probability value. Thus, the power that is exceeded with a given probability can be determined very easily.

If marker 1 is in the switched-off state, it will be switched on automatically.

```
Remote: CALC:MARK:Y:PERC 0...100%
```

NO OF SAMPLES *NO OF SAMPLES* softkey sets the number of power measurements taken into account for the statistics.

Note:

The overall measurement time is influenced by the number of samples selected as well as by the resolution bandwidth set up for the measurement as the resolution bandwidth directly influences the sampling rate.

```
Remote: CALC:STAT:NSAM <value>
```

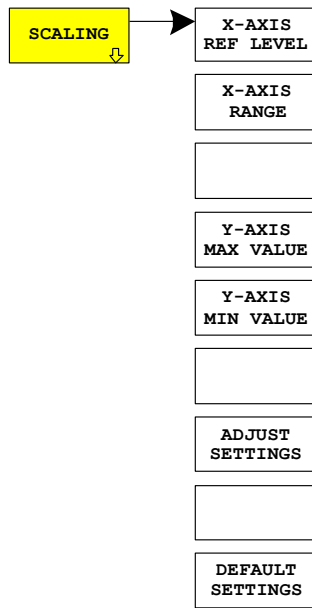

The *SCALING* softkey opens a sub menu that allows changing the scaling parameters for both the x- and the y-axis.

X-AXIS REF LEVEL

The *X-AXIS REF LEVEL* softkey changes the level settings of the instrument and sets the maximum power to be measured.

The function is identical to softkey *REF LEVEL* in menu *AMPT*.

For the *APD* function this value is mapped to the right diagram border. For the *CCDF* function there is no direct representation of this value on the diagram as the x-axis is scaled relatively to the *MEAN POWER* measured.

Remote: `CALC:STAT:SCAL:X:RLEV <value>`

X-AXIS RANGE

The *X-AXIS RANGE* softkey changes the level range to be covered by the statistics measurement selected.

The function is identical to softkey *RANGE LOG MANUAL* in menu *AMPT*.

Remote: `CALC:STAT:SCAL:X:RANG <value>`

Y-AXIS MAX VALUE

The *Y-AXIS MAX VALUE* softkey defines the upper limit of the displayed probability range.

Values on the y-axis are normalized which means that the maximum value is 1.0. As the y-axis scaling has a logarithmic axis the distance between max and min value must be at least one decade.

Remote: `CALC:STAT:SCAL:Y:UPP <value>`

Y-AXIS MIN VALUE

The *Y-AXIS MIN VALUE* softkey defines the lower limit of the displayed probability range.

As the y-axis scaling has a logarithmic axis the distance between max and min value must be at least one decade. Valid values are in the range $0 < \text{value} < 1$.

Remote: `CALC:STAT:SCAL:Y:LOW <value>`

ADJUST SETTINGS

The *ADJUST SETTINGS* softkey optimizes the level settings of the analyzer according to the measured peak power in order to gain maximum sensitivity of the instrument.

The level range is adjusted according to the measured difference between peak and minimum power for APD measurement and peak and mean power for CCDF measurement in order to obtain maximum power resolution.

Additionally the probability scale is adapted to the selected number of samples.

Remote: CALC:STAT:SCAL:AUTO ONCE

DEFAULT SETTINGS

The *DEFAULT SETTINGS* softkey resets the x- and y-axis scaling to their PRESET values.

x-axis reference level: -20 dBm
 x-axis range APD: 100 dB
 x-axis range CCDF: 20 dB

y-axis upper limit: 1.0
 y-axis lower limit: 1E-6

Remote: CALC:STAT:PRES

ADJUST SETTINGS

The *ADJUST SETTINGS* softkey optimizes the level settings of the analyzer according to the measured peak power in order to gain maximum sensitivity of the instrument.

The level range is adjusted according to the measured difference between peak and minimum power for APD measurement and peak and mean power for CCDF measurement in order to obtain maximum power resolution.

Additionally the probability scale is adapted to the selected number of samples.

Remote: CALC:STAT:SCAL:AUTO ONCE

CONT MEAS

The *CONT MEAS* softkey starts collecting a new sequence of sample data and calculating the APD or CCDF curve depending on the selected measurement. The next measurement is started automatically as soon as the indicated number of samples has been reached ("CONTinuous MEASurement").

Remote: INIT:CONT ON;
 INIT:IMM

SINGLE MEAS

The *SINGLE MEAS* softkey starts collecting a new sequence of sample data and calculating the APD or CCDF curve depending on the selected measurement. At the beginning of the measurement previously obtained measurement results are discarded.

Remote: INIT:CONT OFF;
 INIT:IMM

7.5 Code Domain Measurements on 3GPP FDD Signals

Application Firmware R&S FS-K73 provides the peak code domain error measurement, an EVM measurement of the total signal (composite EVM), prescribed by the 3GPP standard, as well as the code domain power measurement of assigned and unassigned codes. In addition, the symbols demodulated in a slot, the decided bits or the EVM symbol can be displayed for an active channel.

Two signal recording modes are available with Application Firmware R&S FS-K73, depending on the spectrum analyzer on which the firmware is run:

- With Spectrum Analyzer R&S FSP, a section of approx. 2 ms is recorded. This section is searched for the beginning of an arbitrarily selected slot of the 3GPP FDD signal. All analyses are carried out for this slot only. This cuts processing time by a factor of ten compared with the analysis of a complete frame, i.e. it saves approx. 90% processing time.
- With Spectrum Analyzers R&S FSU or R&S FSQ, the user can choose between slot analysis (recording length approx. 2 ms) and frame analysis (recording length approx. 20 ms without multi frame capture), see *MEASURE SLOT/FRAME* softkey. In the latter case, the recorded signal section is searched for the beginning of a 3GPP FDD frame. Starting at the beginning of such a frame, 15 consecutive slots are analyzed. Frame analysis offers additional display modes compared with slot analysis:
 - *POWER VERSUS SLOT*: display of channel power over complete frame
 - *COMPOSITE EVM*: display of composite EVM over all slots of a frame
 - *PEAK CODE DOMAIN ERR*: display of peak code domain error over all slots of a frame.

The two signal recording modes are described jointly in the following. For each softkey/each display mode it is stated to what recording mode it applies (slot or frame analysis). In figures, frame analysis is shown always. The two recording modes can be selected on the spectrum analyzers as follows:

Analyse eines Slots: Spectrum Analyzer R&S FSP or
 Spectrum Analyzer R&S FSU or
 R&S FSQ with *MEASURE SLOT*

Frame analysis Spectrum Analyzer R&S FSU or R&S FSQ with
 (result length one frame): *MEASURE FRAME*

Application firmware R&S FS-K73 offers two different ways of representing the code domain power measurement:

- Representation of all code channels
 Option R&S FS-K73 displays the power of all occupied code channels in a bar graph. The X-axis is scaled for the highest code class or the highest spreading factor (256). Code channels with a lower spreading factor occupy correspondingly more channels of the highest code class. The power of the code channel is always correctly measured in accordance with the actual power of the code channel. Unused code channels are assumed to belong to the highest code class and displayed accordingly. The displayed power of an unused code channel therefore corresponds to the power of a channel with the spreading factor 256 at the respective code position.

- To simplify identification, used and unused channels are displayed in different colours. Used channels are yellow, unused channels are blue.
The measured power always refers to one slot or one half slot, depending on the settings. The time reference for the start of slot 0 is the start of the 3GPP FDD frame.
Representation of channel power versus slots of a 3GPP FDD signal frame (result length one frame only)
In this case the power of a selectable code channel is indicated versus a frame.
The power is measured within one slot or half slot of the selected channel. The time reference for the start of slot 0 is the start of the 3GPP FDD frame.

The measurements symbol EVM, symbol constellation diagram and bitstream are always referred to one slot/halfslot of the selected channel.

The composite EVM and peak code domain error measurements are always referred to the total signal.

For code domain power (CDP) measurements, the display is operated in the SPLIT SCREEN mode. Only those display modes having the codes of the class with the highest spreading factor as basis for the x-axis are permitted in the upper part of the screen, all other display modes are assigned to the lower part of the screen.

For code domain power measurement, R&S FS-K73 expects the Dedicated Physical Control Channel (DPCCH) to be part of the signal.

There are two modes for the CDP analysis. In the *CODE CHAN AUTOSEARCH* mode, R&S FS-K73 performs an automatic search for active channels in the whole code domain. The channel search is based on the power of the channels and on a signal/noise ratio that should not be exceeded within the channel. In the *CODE CHAN PREDEFINED* mode, the user can define the active channels contained in the signal via tables that can be selected and edited.

7.5.1 Display modes – RESULTS hotkey

Hotkey RESULTS

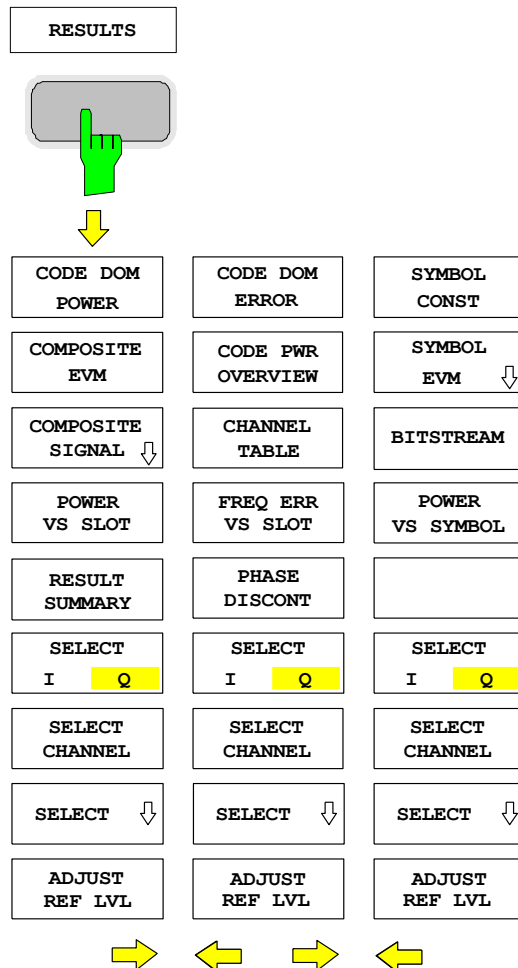

The *RESULTS* hotkey opens a submenu for setting the display mode. The main menu contains the most important display modes as well as the measurements specified by the 3GPP standard for fast access, whereas the side menus contain more detailed display modes.

The following display modes are available:

CODE DOM POWER

Code domain power with relative or absolute scaling (*scaling depends on Toggle Key SETTINGS → CODE PWR ABS / REL*)

- COMPOSITE EVM
(Square difference between test signal and ideal reference signal (*Frame mode only reference to SETTINGS → MEASURE SLOT / FRAME*))
- COMPOSITE SIGNAL
Opens a submenu for display modes that refer to the composite signal (e.g. PEAK CODE DOMAIN ERROR). (*Parts of the displays frame mode only reference to SETTINGS → MEASURE SLOT / FRAME*)

- POWER VS SLOT
Power of the selected channel versus all slots of a 3GPP FDD signal frame.
(Frame mode only reference to SETTINGS → MEASURE SLOT / FRAME)
- RESULT SUMMARY
Tabular result display
- CODE DOM ERROR
Projection of the error between the test signal and the ideal reference signal onto Code Class 8 (CC8) and subsequent averaging using the CC8 symbols of the selected channel slot of the difference signal. The error power is related to the total power of the selected slot and displayed for each code number of CC8.
- CODE PWR OVERVIEW
Code domain power (I and Q component simultaneously)
- CHANNEL TABLE
Display of channel occupation table
- FREQ ERR VS SLOT
Display of frequency error versus slot. (Frame mode only reference to SETTINGS → MEASURE SLOT / FRAME)
- PHASE DISCONT
Display of phase discontinuity versus slot . (Frame mode only reference to SETTINGS → MEASURE SLOT / FRAME)
- POWER VS SYMBOL
Display of symbol power at the selected slot.
- SYMBOL CONST
Darstellung des Constellation-Diagramms
- SYMBOL EVM
Display of constellation diagram
- BITSTREAM
Display of decided bits
- SELECT I/Q
The displayed component of the signal can be selected.
- SELECT CHANNEL
By entering a channel number (*SELCT CHANNEL* softkey) in the modes *CODE DOM POWER* or *CHANNEL TABLE*, it is possible to mark a channel for more detailed display modes:
POWER VS SLOT,
RESULT SUMMARY
POWER VS SYMBOL,
SYMBOL CONST,
SYMBOL EVM,
BITSTREAM.
- SELECT
Opens a submenu for entering display configuration parameters
(e.g. slot selection)
- SELECT SLOT
(Frame mode only reference to SETTINGS → MEASURE SLOT / FRAME). In the following display modes, a slot/half slot (see *SLOT RES HALF / FULL* softkey) can be marked by entering a slot/half slot number using the *SELECT SLOT* softkey:

POWER VS SLOT
 PEAK CODE DOMAIN ERROR
 COMPOSITE EVM
 FREQ ERR VS SLOT
 PHASE DISCONT

The following measurement results are displayed for the selected slot/half slot:

CODE DOMAIN POWER
 RESULT SUMMARY
 CODE DOMAIN ERROR POWER
 CHANNEL TABLE
 POWER VS SYMBOL
 SYMBOL CONST
 SYMBOL EVM
 BITSTREAM

- ADJUST REF LVL

Optimal matching of the reference level to the signal level can be achieved.

Above the diagram, the most important measurement settings, which form the basis of the display modes, are summarized:

Code Power Relative		SR 960 ksps
		Chan 2 / Q
CF 1.935 GHz	Slot # 0	Meas Int Slot

Figure 7-6: Indication of measurement parameters

The different elements are

1st column:

Code Power Relative: Name of selected display mode

{empty}

CF 1.935 GHz: Center frequency of signal

2nd column:

{empty}

{empty}

Slot # 0: Slot number (value of SELECT SLOT softkey)

This value is only displayed at a result length of one frame. The entry is coupled with the softkey *SLOT RES HALF / FULL*: If *SLOT RES FULL* is chosen, values will be from 0 to 14. At *SLOT RES HALF* values will be from 0 to 29 while the caption turns from Slot # to HSlot #.

3rd column:

SR 960 ksps: Symbol rate of selected channel

Chan 2 / Q: Spreading code of selected channel

Meas Int Slot: Measurement interval for graphical displays (see *SLOT RES HALF / FULL* softkey)



For the peak code domain error display mode, the indication of the symbol rate is replaced by the indication of the spreading factor onto which the error is projected (see PEAK CODE DOMAIN ERR softkey).

**CODE DOM
POWER**

The *CODE DOM POWER* softkey selects the code domain power display mode.

The scaling of the displayed result depends on the softkey *SETTINGS* → *CODE PWR ABS / REL*. In case of a relative display (*REL*), the power of the channels is referenced to the total power of the selected slot. The values are specified in dB. In case of an absolute display (*ABS*), the absolute power values are specified in dBm.

The measurement interval for determining the power of the channels depends on the value of softkey *SLOT RES HALF / FULL*: For *SLOT RES FULL* the measurement interval is one complete slot (2560 chips), while for *SLOT RES HALF* the length of the measurement interval turns to one half slot (1280 chips). The time reference for the start of slot 0 is the start of the 3GPP FDD frame.

The powers of the active channels and of the unassigned codes are shown in different colours:

- yellow: active channels
- blue: unassigned codes

In the *CODE CHAN AUTOSEARCH* mode, a data channel is designated as active if its power has a minimum value compared to the total power of the signal and if a minimum signal/noise ratio is maintained within the channel.

In *CODE CHAN PREDEFINED* mode, each data channel that is included in the user defined channel table is considered to be active.

The received pilot symbols of the DPCCH are compared to the prescribed pilot symbols of the 3GPP standard. If some of these pilot symbols are not equal to the symbols of the 3GPP standard a message "INCORRECT PILOT" is displayed.

By entering a channel number (see *SELECT CHANNEL* softkey) it is possible to mark a channel for more detailed display modes. The marked channel is shown in red. The whole channel is marked if it is an assigned channel, and only the entered code is marked in the case of an unassigned code.

The display mode for the path of representation and the slot can be varied using the *SELECT I/Q* and *SELECT SLOT* (frame analysis only) softkeys.

Selecting other display modes (e.g. *SYMBOL CONSTELLATION*) for unassigned codes is possible but not useful since the results are not valid.

The figure shows the relative CDP representation of the Q path for 3 data channels that are active in this path. The figure shows the relative CDP representation of the Q path for 3 data channels that are active in this path.



Figure 7-7: Code domain power, branch Q

```
Remote: CALC1:FEED "XPOW:CDP"
        CALC1:FEED "XPOW:CDP:ABS"
        CALC1:FEED "XPOW:CDP:RAT"
```

COMPOSITE EVM

The *COMPOSITE EVM* softkey selects the composite EVM display mode according to 3GPP specification. The softkey is only valid if one frame of the 3GPP signal is analyzed.

During the composite EVM measurement, the square root of the squared errors between the real and imaginary parts of the test signal and an ideal reference signal (EVM referred to the total signal) is determined. Composite EVM thus is a measurement of the composite signal.

The measurement result consists of one composite EVM measurement value per slot or half slot, depending on the value of softkey *SLOT RES HALF / FULL*. For *SLOT RES FULL*, this results in a total of 15 values to be displayed for composite EVM. For *SLOT RES HALF* the number of values displayed will turn to 30. The time reference for the start of slot 0 is the start of the 3GPP FDD frame.

Only the channels recognized as active are used to generate the ideal reference signal. If an assigned channel is not recognized, the difference between the measurement and reference signal and the composite EVM is very high.

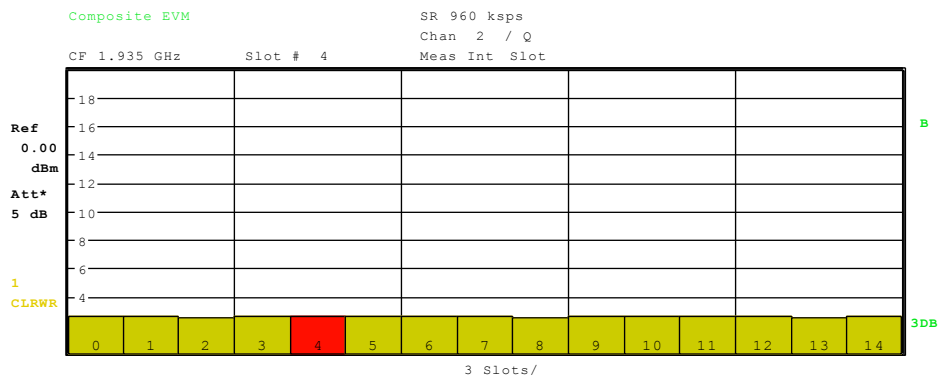
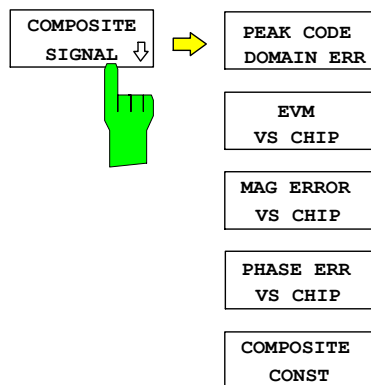

Figure 7-8: Display of composite EVM

```
Remote: CALC2:FEED "XTIM:CDP:MACC"
```



The *COMPOSITE SIGNAL* softkey opens a submenu for evaluation displays of the composite WCDMA signal versus time. Different measurements are supported:

- **PEAK CODE DOMAIN ERR**
Projection of the error between the test signal and the ideal reference signal onto Code Class 8 and subsequent summation using the symbols of each slot of the difference signal. (Frame mode only reference to SETTINGS → MEASURE SLOT / FRAME)
- **EVM VS CHIP**
Square root of square difference between received signal and reference signal at chip level, displayed for each chip.
- **MAG ERROR VS CHIP**
Difference between the amplitude of the received signal and the reference signal at chip level, displayed for each chip.
- **PHASE ERR VS CHIP**
Phase difference between the received signal vector and the reference signal vector at chip level, displayed for each chip.
- **COMPOSITE CONST**
Constellation diagram of received signal (scrambled chips):

PEAK CODE DOMAIN ERR

The *PEAK CODE DOMAIN ERR* softkey selects the peak code domain error display mode. The softkey is only valid if one frame of the 3GPP signal is analyzed.

In line with the 3GPP specifications, the error between the measurement signal and the ideal reference signal is projected onto spreading factor 256. This spreading factor can be changed via a table that is shown after the *PEAK CODE DOMAIN ERR* softkey has been pressed. The spreading factor the signal is projected onto is indicated within the measurement parameters shown above the peak code domain error diagram.

The measurement result consists of one peak code domain error measurement value per slot or half slot, depending on the value of softkey *SLOT RES HALF / FULL*. For *SLOT RES FULL*, this results in a total of 15 values to be displayed for peak code domain error. For *SLOT RES HALF* the number of values displayed will turn to 30. The time reference for the start of slot 0 is the start of the 3GPP FDD frame.

Only the channels recognized as active are used to generate the ideal reference signal for the peak code domain error. If an assigned channel is not recognized, the difference between the measurement and reference signal is very high. R&S FS-K73 consequently indicates a peak code domain error that is too high.

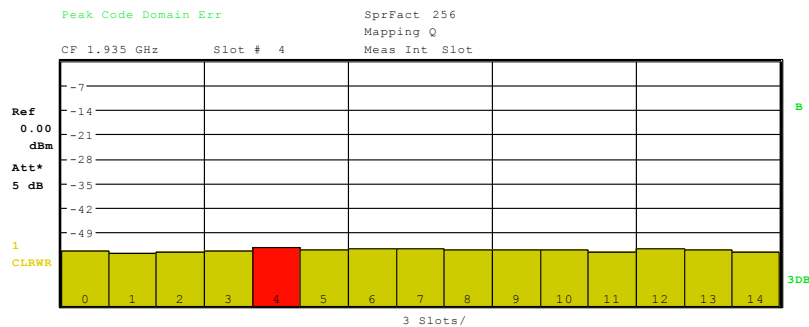

Figure 7-9: Display of Peak code domain error

Remote: CALC2:FEED "XTIM:CDP:ERR:PCD"

EVM VS CHIP

The *EVM VS CHIP* activates the Error Vector Magnitude (EVM) versus chip display. In case of *SLOT RES FULL* (see softkey *SLOT RES HALF / FULL*), the EVM is displayed for all chips of the selected slot, in case of *SLOT RES HALF*, EVM is displayed for the chips of one half slot. The selected slot / halfslot can be varied by the *SELECT SLOT* softkey. Possible entries for the *SELECT SLOT* softkey are 0 to 14 for *SLOT RES FULL* and 0 to 29 for *SLOT RES HALF*.

The EVM is calculated to be the root of the squared difference between the received and reference signal. The reference signal is estimated out of the channel configurations of all active channels. The EVM is given in percent referred to the square root of the mean power of the reference signal.

The EVM is calculated to be the root of the squared difference between the received and reference signal. The reference signal is estimated out of the channel configurations of all active channels. The EVM is given in percent referred to the square root of the mean power of the reference signal.

$$EVM_k = \sqrt{\frac{|s_k - x_k|^2}{\frac{1}{N} \sum_{n=0}^{N-1} |x_n|^2}} \cdot 100\% \quad | \quad N = 2560 \quad | \quad k \in [0 \dots (N-1)]$$

where: EVM_k - vector error of the chip EVM of chip number k

s_k - complex chip value of received signal

x_k - complex chip value of reference signal

k - index number of the evaluated chip

n - index number for mean power calculation of reference signal.

N - number of chips at each CPICH slot

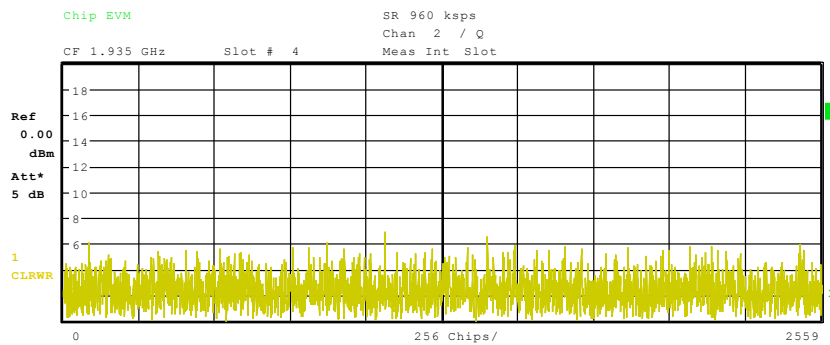

Figure 7-10: Display of chip EVM

Remote: CALC2:FEED "XTIM:CDP:CHIP:EVM"

Query of results: TRACe:DATA? TRACe2

Unit: [%]

Range: [0 % ... 100 %]

MAG ERROR VS CHIP

The *MAG ERROR VS CHIP* softkey activates the Magnitude Error versus chip display. In case of *SLOT RES FULL* (see softkey *SLOT RES HALF / FULL*), the magnitude error is displayed for all chips of the selected slot, in case of *SLOT RES HALF*, magnitude error is displayed for the chips of one half slot. The selected slot / halfslot can be varied by the *SELECT SLOT* softkey. Possible entries for the *SELECT SLOT* softkey are 0 to 14 for *SLOT RES FULL* and 0 to 29 for *SLOT RES HALF*.

The magnitude error is calculated to be the difference between the magnitudes of the received and reference signal. The reference signal is estimated out of the channel configurations of all active channels. The magnitude error is given in percent referred to the square root of the mean power of the reference signal.

$$MAG_k = \frac{|s_k| - |x_k|}{\sqrt{\frac{1}{N} \sum_{n=0}^{N-1} |x_n|^2}} \cdot 100\% \quad | \quad N = 2560 \quad | \quad k \in [0 \dots (N-1)]$$

where: MAG_k - magnitude error of chip number k

s_k - complex chip value of received signal

x_k - complex chip value of reference signal

k - index number of the evaluated chip

n - index number for mean power calculation of reference signal

N - number of chips at each CPICH slot

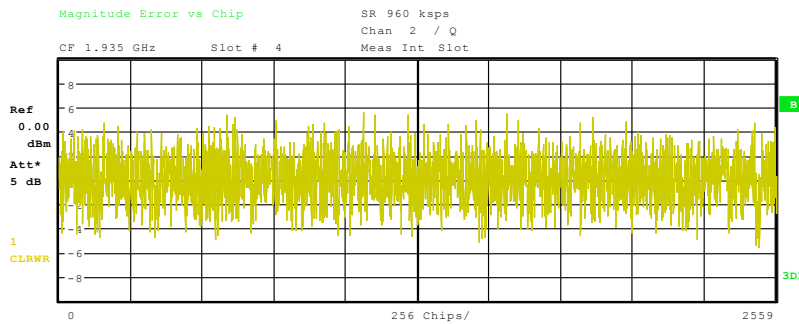

Figure 7-11: Darstellung des Magnitude Error versus Chip
 Remote: CALC2:FEED "XTIM:CDP:CHIP:MAGNitude"

Query of results: TRACe:DATA? TRACe2
 Unit: [%]
 Range: [-100 % ... 100 %]

PHASE ERR VS CHIP

The *PHASE ERR VS CHIP* softkey activates the Phase Error versus chip display. In case of *SLOT RES FULL* (see softkey *SLOT RES HALF / FULL*), the phase error is displayed for all chips of the selected slot, in case of *SLOT RES HALF*, the phase error is displayed for the chips of one half slot. The selected slot / halfslot can be varied by the *SELECT SLOT* softkey. Possible entries for the *SELECT SLOT* softkey are 0 to 14 for *SLOT RES FULL* and 0 to 29 for *SLOT RES HALF*.

The phase error is calculated to be the difference between the phases of the received and reference signal. The reference signal is estimated out of the channel configurations of all active channels. The magnitude error is given in grad ranging from -180° to 180°.

$$PHI_k = \phi(s_k) - \phi(x_k) \quad | \quad N = 2560 \quad | \quad k \in [0 \dots (N-1)]$$

- where: PHI_k - phase error of chip number k
- s_k - complex chip value of received signal
- x_k - complex chip value of reference signal
- k - index number of the evaluated chip
- N - number of chips at each CPICH slot
- $\phi(x)$ - phase calculation of a complex value

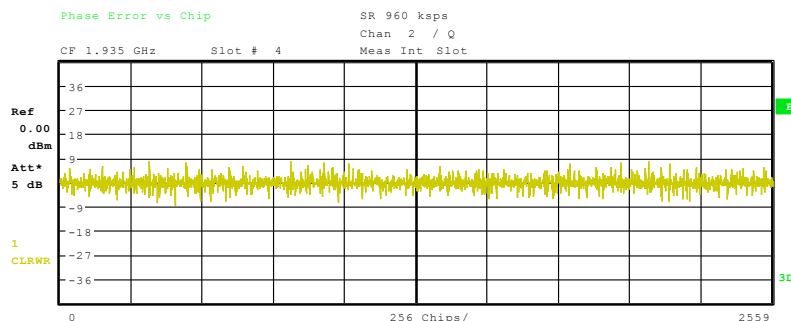

Figure 7-12: Display of phase error versus chip
 Remote: CALC2:FEED "XTIM:CDP:CHIP:PHAS"

Query of results: TRAC:DATA? TRAC2
 Unit: [°]
 Range: [-180° ... 180°]

COMPOSITE CONST

The *COMPOSITE CONST* softkey selects the display of the constellation diagram for the chips of all channels. The displayed constellation points are normalized to the square root of the total power.

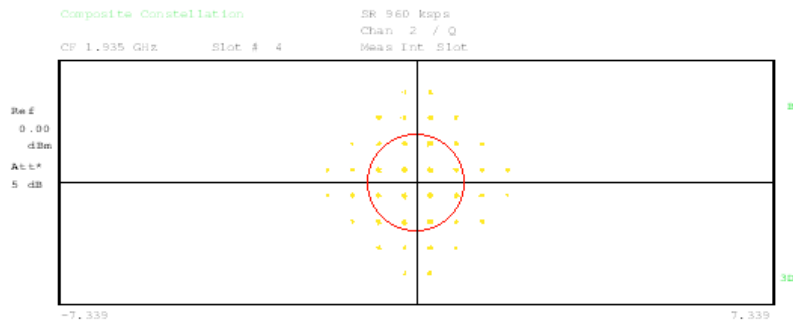

Figure 7-13: Display of composite constellation diagram (scrambled chips)

Remote: CALC2:FEED "XTIM:CDP:COMP:CONS"

Query of results: TRACe:DATA? TRACe2
 Format: $Re_1, Im_1, Re_2, Im_2, \dots, Re_{2560}, Im_{2560}$
 Unit: [1]

POWER VS SLOT

The *POWER VS SLOT* softkey selects the indication of the power of the selected code channel depending on the slot number. The power of the selected channel (marked red in the CDP diagram) is displayed versus all slots of a frame of the 3GPP FDD signal. The softkey is only valid if one frame of the 3GPP signal is analyzed.

Beginning at the start of the 3GPP FDD frame, 15 or 30 successive slots/half slots are displayed, depending on the value of the *SLOT RES HALF / FULL* softkey. The power is shown in absolute scaling or referenced to the total signal power, see softkey *CODE PWR ABS / REL*.

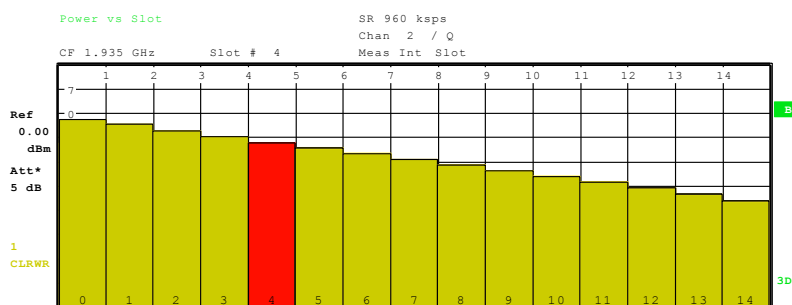

Figure 7-14: Power versus Slot measurement for an active channel

It is not only possible to select a code channel in the CDP diagram, but also to mark a slot in the power-versus-slot diagram. Marking is done by entering the slot number (see *SELECT SLOT* softkey) and the selected slot is marked in red. For more detailed displays, the marked slot of the channel is selected (see *SLOT #* entry in the function panels above the diagrams in the Figures).

Modifying a slot number has the following effects:

- The CDP diagram in the upper half of the display is updated referred to the entered slot number.
- All results that depend on the selected slot are recalculated for selected channel. The relevant graphics are updated.

Remote: CALC2:FEED "XTIM:CDP:PVSL"

RESULT SUMMARY

The *RESULT SUMMARY* softkey selects the numerical display of all results. The display is subdivided as follows:

Result Summary		SR 960 kbps	
		Chan 2 / Q	
CF 1.935 GHz	Slot # 4	Meas Int Slot	
GLOBAL RESULTS FOR FRAME 0:			
Total Power	-0.06 dBm	Carrier Freq Error	-58.45 Hz
Ref 0.00 dBm	Chip Rate Error 0.06 ppm	Trigger to Frame	640.021536 μs
Att* 5 dB	IQ Offset / Imb 1.03 / 0.13 %	Avg Pow Ina Chan	-71.78 dB
	Composite EVM 2.67 %	Pk CDE (15 kbps)	-53.21 dB
	Rho 0.99930	Avg RCDE (4PAM)	-.- dB
		No of Active Chan	7
CHANNEL RESULTS			
	Symbol Rate 960.00 kbps	RCDE	-48.24 dB
1 CLRWR	Channel Code 2	Timing Offset	0 Chips
	No of Pilot Bits 0	Channel Mapping	Q
	Channel Power Rel -8.44 dB	Modulation Type	BPSK Q
	Symbol EVM 2.39 % rms	Channel Power Abs	-8.50 dBm
		Symbol EVM	6.34 % Pk

Figure 7-15: Display of Result Summary

Im oberen Teil werden Messergebnisse angegeben, die das Gesamt-Signal betreffen:

Total Power: Outputs the total signal power (average power of total evaluated 3GPP FDD frame).

Chip Rate Error: Outputs the chip rate error in ppm

As a result of a high chip rate error symbol errors arise and the CDP measurement is possibly not synchronized to the 3GPP FDD signal. The result is valid even if the synchronization of analyzer and signal failed.

IQ Offs / Imb: DC offset and IQ imbalance of the signal in % (see "Explanation of IQ impairment model"). If K73+ key is installed, the IQ offset is measured together with all other relevant parameters that describe the in-channel quality of the signal in a single measurement process. If K73+ key is not installed IQ offset is measured together with IQ imbalance after the in-channel measurement has been done.

Composite EVM: The composite EVM is the difference between the test signal and the ideal reference signal (see *COMPOSITE EVM* softkey). The composite EVM value for the selected slot is given in the *RESULT SUMMARY*.

Rho: Quality parameter rho for every slot.

Av Pow Ina Chan: The power in the code domain of all inactive channels is averaged to give the user an overview on the difference between active and inactive channels.

Carrier Freq Error: Outputs the frequency error referred to the center frequency of the analyzer. The absolute frequency error is the sum of the analyzer and

DUT frequency error.

Differences of more than 1 kHz between transmitter and receiver frequency impair the synchronization of the CDP measurement. For this reason, the transmitter and receiver should be synchronized (see chapter Getting Started).

Trigger to Frame: This result outputs the timing offset from the beginning of the recorded signal section to the start of the analyzed 3GPP FDD frame. In the case of triggered data collection, this timing offset is identical with the timing offset of frame trigger (+ trigger offset) – frame start. In the case of failure of the synchronization of analyzer and 3GPP FDD signal, the value of Trigger to Frame is not significant.

Avg RCDE: Average of residual code domain errors of all channels that use 4PAM modulation. The entry is valid only if K73+ key is installed, otherwise “-.-” is used. If the signal does not contain channels with 4PAM modulation, “-.-” is used too.

No of Active Chan:

Indicates the number of active channels detected in the signal. Both the detected data channels and the control channels are considered active channels.

The results of measurements on the selected channel (red in the CDP diagram) are displayed in the lower part of the *RESULT SUMMARY*.

Symbol Rate: Symbol rate at which the channel is transmitted.

Channel Code: Number of the spreading code of the selected channel

No of Pilot Bits: Indicates the number of pilot bits detected in the control channel.

Chan Pow Rel. / Abs.:

Channel relative (referred to the total power of the signal) and absolute t.

Symbol EVM Pk / rms:

Peak or average of the results of the error vector magnitude measurement (see SYMBOL EVM softkey). The measurement provides information on the EVM of the channel (marked red) in the CDP diagram in the slot (marked red) of the power-versus-slot diagram at symbol level.

RCDE: Residual code domain error of the channel according to 3GPP.

Timing Offset: Offset between the start of the first slot in the channel and the start of the analyzed 3GPP FDD frame

Channel Mapping: Component onto which the channel is mapped (I or Q)

Modulation Type: :Indicates the modulation type of the selected channel. Valid entries are BPSK I for channels on branch I, BPSK Q for channels on branch Q and NONE for inactive channels. If R&S FS-K73+ key is installed, additional valid entries are 4PAM_I and 4PAM_Q for

channels that use 4PAM modulation.

```
Remote:          CALC2:FEED "XTIM:CDP:ERR:SUMM"
                  CALC1:MARK1:FUNC:WCDP:RES?
                  PTOT | FERR | TFR | TOFF | MACC | PCD |
                  EVMR | EVMP | CERR | CSL | SRAT | CHAN |
                  CDP | CDPR | IQOF | IQIM | RHO | TOFF |
                  MTYP | ACH | MPIC
```

Explanation of IQ impairment model

In RF devices including analog mixers such as up-converter, the analog complex base band signal ($r(t)=r_I(t)+j \cdot r_Q(t)$) is shifted to a real high frequency signal ($s_{HF}(t)$) (Figure 7-16). Each non-ideal complex mixer adds IQ impairments to the base band signal. Two of them, the IQ offset and the IQ imbalance are estimated by the R&S FS-K73. Both values are given in the Result Summary display. The estimation and display of IQ offset and IQ imbalance do NOT depend on the status of the NORMALIZE ON/OFF key. The key only controls an algorithm which compensates the IQ offset to normalize the constellation diagram to the origin.

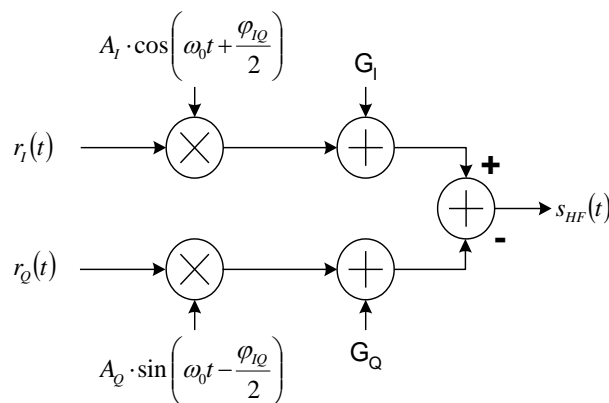

Figure 7-16: Basic model of possible IQ impairment parameters in complex up converter devices

IQ-Offset The IQ offset is given in the Result Summary display. It represents a complex offset which leads to a shifted composite constellation diagram. The value is given relative to the mean power of the signal. It is calculated as follows:

$$\text{offset}_{IQ} = |g| \cdot 100\% = \sqrt{|g_I + j \cdot g_Q|^2} \cdot 100\% = \sqrt{\frac{G_I^2 + G_Q^2}{\frac{1}{T} \int_0^T |r(t)|^2 dt}} \cdot 100\%$$

where:

$ g $	magnitude of the relative IQ offset
g_I	relative IQ offset of the real part
g_Q	relative IQ offset of the imaginary part
G_I	absolute IQ offset of the real part
G_Q	absolute IQ offset of the imaginary part
$r(t)$	complex base band signal (reference signal matching with optimum EVM assuming that AWGN is given)
T	- evaluation time ($T=666 \mu\text{s} \rightarrow 1 \text{ slot}$)

offset_{IQ} - IQ offset parameter

IQ-Imbalance The IQ imbalance is given in the Result Summary in the Result Summary display. It represents a complex gain error between the mixer gain in the I path and the mixer gain in the Q path. We assume that a base band signal $r(t)$ is multiplied by a complex analog oscillator with radian frequency $\omega_0=2\pi * f_0$ Figure 7-16). The complex signal $r(t)$ can be split into a real part $\{r_I(t)\}$ and an imaginary part $\{r_Q(t)\}$. Using this assumption, an ideal complex local oscillator (LO_{ideal}) can also be described by two real sinusoidal signals with a phase offset of 90° . These signals are described as $\cos(\omega_0 t)$ and $\sin(\omega_0 t)$.

$$LO_{ideal} = A \cdot \exp(j\omega_0 t) = A \cdot \cos(\omega_0 t) + j \cdot A \cdot \sin(\omega_0 t)$$

The local oscillator is not ideal in an analog mixer. Normally there are two different amplitude values (A_I and A_Q) in each (Figure 7-16) path. Moreover, an unwanted phase shift (φ_{IQ}) between the real part and the imaginary part of the local oscillator ($LO_{impairment}$) may occur. Considering these impairments a non ideal LO can be described as follows:

$$LO_{impairment} = A_I \cdot \cos\left(\omega_0 t + \frac{\varphi_{IQ}}{2}\right) + j \cdot A_Q \cdot \sin\left(\omega_0 t - \frac{\varphi_{IQ}}{2}\right)$$

The IQ imbalance expresses the relative gain error of the mixer. It is calculated as follows:

$$imbalance_{IQ} = \sqrt{\frac{\left|A_I \cdot \exp\left(j \frac{\varphi_{IQ}}{2}\right) - A_Q \cdot \exp\left(-j \frac{\varphi_{IQ}}{2}\right)\right|^2}{\left|A_I \cdot \exp\left(j \frac{\varphi_{IQ}}{2}\right) + A_Q \cdot \exp\left(-j \frac{\varphi_{IQ}}{2}\right)\right|^2}} \cdot 100\%$$

where: A_I - amplitude mixer gain of the real part
 A_Q - amplitude mixer gain of the imaginary part
 φ_{IQ} - additional phase shift between real part and imaginary part

imbalance_{IQ} - IQ imbalance parameter
 $r(t)$ - complex base band signal (reference signal matching with optimum EVM assuming that AWGN is given)



The displayed IQ impairments and the EVM value are calculated based on a comparison between an estimated ideal base band signal and the received signal. The fact that it depends on the detected channel configuration can be explained as follows: the estimated ideal signal based on a channel configuration including these additionally detected leakage power channels matches far better with the received signal than the estimated ideal signal. This estimated ideal signal is based on a channel configuration of actually sent active channels.

A false detection of leakage power channels is indicated in the code domain power display (CDP) where all active channels are highlighted in yellow. All active channels are yellow. Yellow channels of low power and high data rate are most likely code channels. To suppress these channels, a PREDEFINED channel table can be used. A predefined channel table can be set via the CHAN CONF menu. This menu is selected by a softkey at the bottom of the screen.

CODE DOM ERROR

The *CODE DOM ERROR* softkey selects the code domain error power (CDEP) display mode. The displayed error power is always referred to the total power.

The code domain error power (CDEP) is calculated by subtracting a chip-stream of a generated reference signal ($chip_{ref}$) from the received chips ($chip_{rec}$). This difference signal is de-spread to all 256 code channels of code class 8 ($Dspr_n$). The average power of the error symbols of the selected slot is related to the total power of the selected slot. The measurement interval for determining the CDEP of the channels is one slot or one half slot, depending on *SLOT RES HALF / FULL*: at *SLOT RES FULL* one complete slot is used for determining the CDEP, at *SLOT RES HALF* half of a slot is used.

$$CDEP = \frac{\frac{1}{N} \sum_{n=1}^N \left[\text{Re} \left\{ Dspr_n \left(chip_{rec} - chip_{ref} \right) \right\}^2 + \text{Im} \left\{ Dspr_n \left(chip_{rec} - chip_{ref} \right) \right\}^2 \right]}{\frac{1}{N} \sum_{n=1}^N \left[\text{Re} \left\{ Dspr_n \left(chip_{ref} \right) \right\}^2 + \text{Im} \left\{ Dspr_n \left(chip_{ref} \right) \right\}^2 \right]}$$

The powers of the active channels and of the unassigned codes are shown in different colours:

- yellow: active channels
- blue: unassigned codes

The CDEP is calculated for each channel of code class 8 (CC8). In case of an active code channel of a lower code class, all included CC8 channels are marked yellow. The power is displayed for each CC8 channel and not subsumed for all CC8 channels of the active channel.

By entering a channel number (see *SELECT CHANNEL* softkey), it is possible to mark a channel for more detailed display modes. The first CC8 code channel of a marked channel of a lower code class is shown in red

The figure below shows the I and Q branch with no code domain error

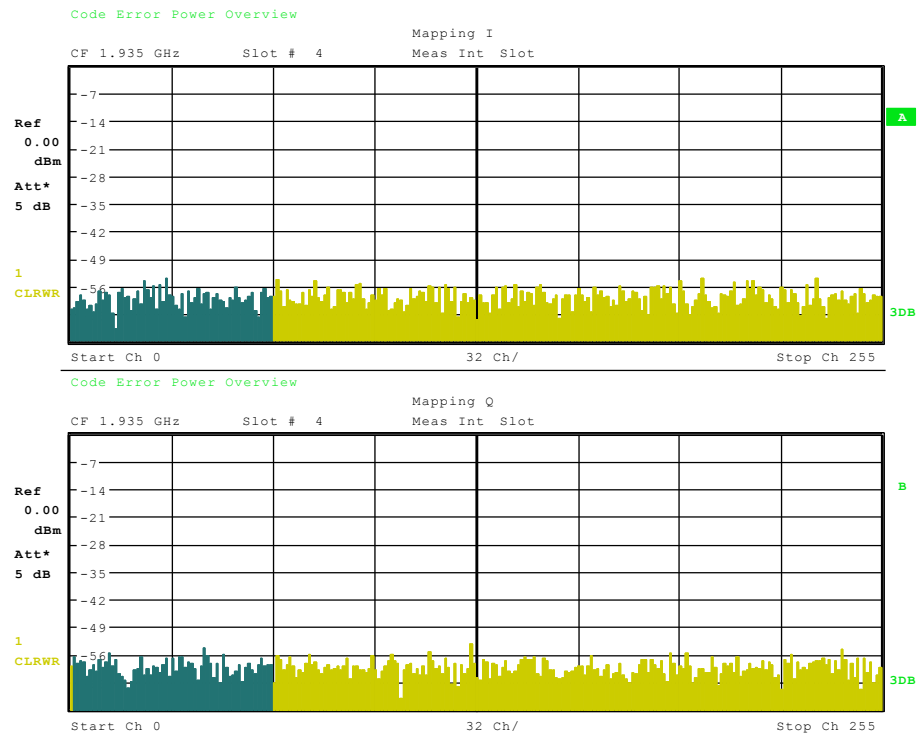

Figure 7-17: Code domain error display: Signal with no code domain error in the I and Q branch

If a channel is not detected, a code domain error will occur. The power level of the error is similar to the power of the CC8 channels in the code range of the undetected code. This case is shown in the figure below.

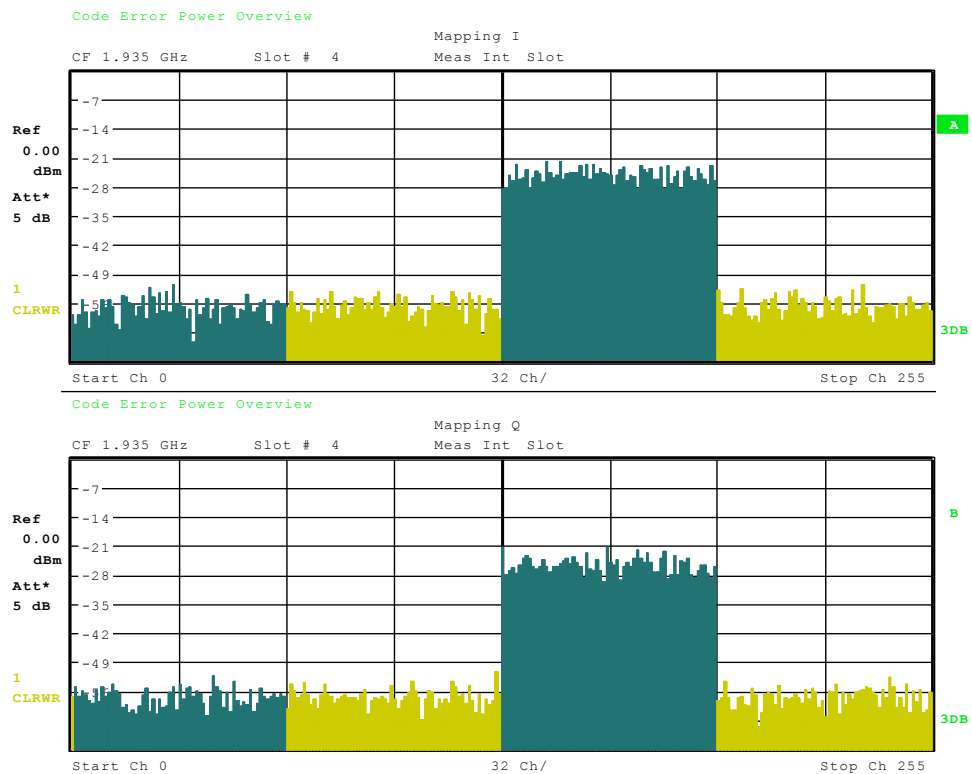

Figure 7-18: Code domain error display: Signal with no code domain error in the I and Q branch

Remote: CALC1:FEED "XPOW:CDEP"

Query of results: TRAC1:DAT? TRAC1

Ausgabe: CDEP Liste für jeden CC8 Code Kanal

Format: <code class>₁, <code number>₁, <CDEP>₁, <channel flag>₁, <code class>₂, <code number>₂, <CDEP>₂, <channel flag>₂,
,...,
<code class>₂₅₆, <code number>₂₅₆, <CDEP>₂₅₆, <channel flag>₂₅₆

Unit: < [1] >, < [1] >, < [dB] >, < [1] >

Range: < 8 >, < 0...256 >, < -∞ ... ∞ >, < 0 ; 1 >

Quantity: 256

code class: Highest code class of a WCDMA signal is always set to 8 (CC8)

code number: Code number of the evaluated CC8 channel

CDEP: Code domain error power value of the CC8 channel

channel flag: Indicates whether the CC8 channel belongs to an assigned code channel or not:

Range: 0b00 0d0 - CC8 is inactive

0b01 0d1 - CC8 channel belongs to an active code channel

CODE PWR OVERVIEW

The *CODE PWR OVERVIEW* softkey enables screen B to show a code power display. By enabling the overview mode, both mappings (I mapping and Q mapping) are

displayed. In this case the I mapping is displayed in screen A, which corresponds to trace 1, and the Q mapping is displayed in screen B, which corresponds to trace 2. The softkey can be used in code domain power (CDP) measurements for absolute or relative scaling as well as in code domain error power (CDEP) measurements

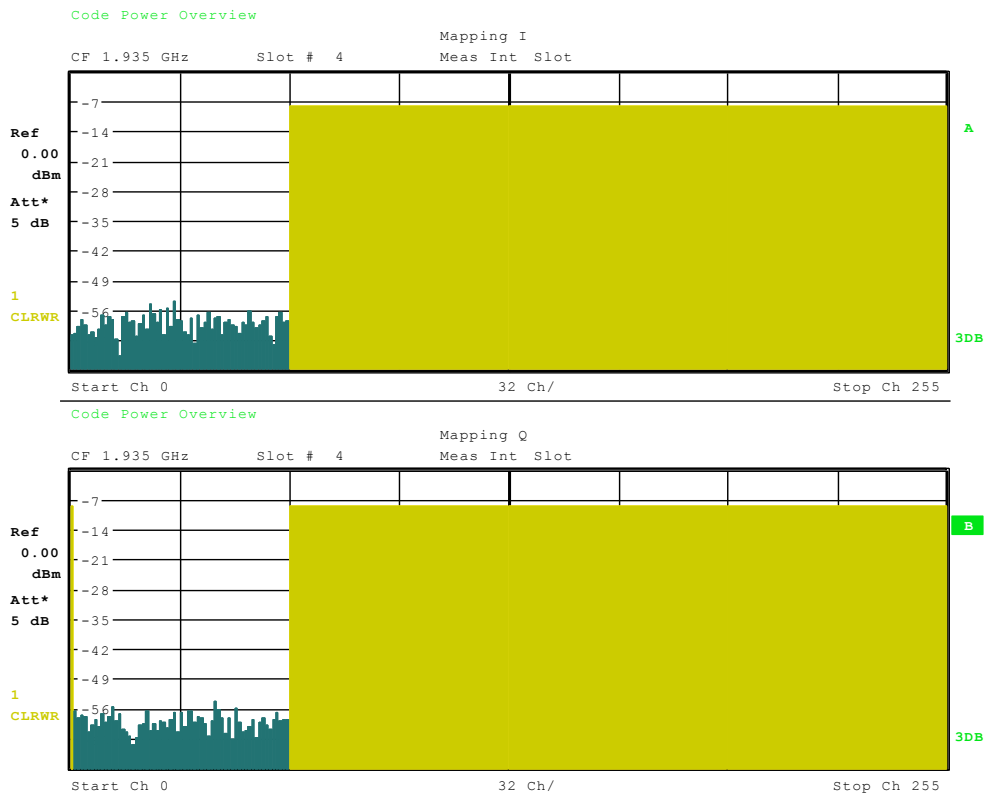

Figure 7-19: Code Domain Power in Überblicksdarstellung

Remote: SENS:CDP:OVER ON | OFF

ON: Code Power Overview On mode.

Screen A: I mapping (TRACE1) (CDP_{abs.} or CDP_{rel.} or CDEP)

Screen B: Q mapping (TRACE2) (CDP_{abs.} or CDP_{rel.} or CDEP)

OFF: Code Power Overview Off mode.

Screen A: I mapping (TRACE1) (CDP_{abs.} or CDP_{rel.} or CDEP)

Screen B: Result summary (TRACE2)

CALC1:FEED 'XPOW:CDP:OVER'

Screen A: I mapping (TRACE1) (CDP_{rel.})

Screen B: Q mapping (TRACE2) (CDP_{rel.})

CHANNEL TABLE

The *CHANNEL TABLE* softkey selects the display of the channel assignment table. The channel assignment table can contain a maximum of 512 entries, corresponding to the 256 codes that can be assigned within the class of spreading factor 256, both I and Q components.

The upper part of the table indicates the DPCCH channel that has to be present in every signal to be analyzed. Furthermore there are additional control channels used in HSDPA and HSUPA signals. These channels (HSDPCCH and EDPCCH) are also displayed in

the upper part of the table.

The lower part of the table indicates the data channels (DPDCH and E-DPDCH) that are contained in the signal. As specified in 3GPP, the channel table can contain up to 6 DPDCHs or up to 4 E-DPDCHs. The channels are in descending order according to symbol rates and within a symbol rate in ascending order according to the channel numbers. Therefore, the unassigned codes are always to be found at the end of the table.

Physical channels used in 3GPP UPLINK signals according to Release 99 specification:

DPCCH: The **Dedicated Physical Control Channel** is used to synchronize the signal. It carries pilot symbols and is expected in the Q branch at code class 8 with code number 0. The channel is displayed in the upper part of the table.

DPDCH: The **Dedicated Physical Data Channel** is used to carry UPLINK data from the UE to the BS. The code allocation depends on the total required symbol rate. The following table represents the possible configurations of DPCH spreading factors and code allocation.

Channel Table

SR 960 ksps
Chan 2 / Q
Meas Int Slot

CF 1.935 GHz Slot # 4

Chan Type	Symb Rate [ksps]	Chan#	Status	Mapping	PilotL [Bits]	Pwr Abs [dBm]	Pwr Rel [dB]
DPCCCH	15.0	0	active	Q	8	-8.53	-8.47
HSDPCCH	-.-	---	inactv	I	---	-.-	-.-
EDPCCH	-.-	---	inactv	I	---	-.-	-.-
DPDCH	960.0	1	active	I	---	-8.49	-8.43
DPDCH	960.0	1	active	Q	---	-8.53	-8.47
DPDCH	960.0	2	active	I	---	-8.50	-8.44
DPDCH	960.0	2	active	Q	---	-8.50	-8.44
DPDCH	960.0	3	active	I	---	-8.52	-8.46
DPDCH	960.0	3	active	Q	---	-8.51	-8.46
DPDCH	15.0	0	inactv	I	---	-61.99	-61.93

Ref 0.00 dBm
Att* 5 dB

3dB

Figure 7-20: Channel Table of an UPLINK signal according to Release 99 specification

HSDPCCH: The **High Speed Dedicated Physical Control Channel** (for HS-DCH) is used to carry control information (CQI / ACK/NACK) for downlink high speed data channels (HS-DCH). It is used in HSDPA signal setup. The data rate is fixed to 15ksps. The code allocation depends on the number of active DPCH and is described in the table below. This control channel is displayed in the upper part of the channel table. The HS-DPCCH can be switched on or off for a duration of 1/5 frame → 3 slots → 2ms. Power control is applicable too.

E-DPCCH: The **Enhanced Dedicated Physical Control Channel** is used to carry control information for uplink high speed data channels (EDPDCH). It is used in HSUPA signal setup. The data rate is fixed to 15ksps. This control channel is displayed in the upper part of the channel table.

E-DPDCH: The **Enhanced Dedicated Physical Data Channel** is used to carry UPLINK data for high speed channels (EDPDCH). It is used in HSUPA signal setup. The data rate and code allocation depends on the number of DPDCH and HS-DPCCH (refer to table below). This data channel is displayed in the lower part of the channel table

Channel Table

SR 15 kbps
Chan 1 / I
Meas Int Slot

CF 1.935 GHz Slot # 6

	Chan Type	Symb Rate [kpbs]	Chan#	Status	Mapping	PilotL [Bits]	Pwr Abs [dBm]	Pwr Rel [dB]	
Ref 0.00 dBm	DPCCH	15.0	0	active	Q	8	-10.86	-1.65	A
	HSDPCCH	15.0	33	active	Q	---	-26.92	-17.70	
	EDPCCH	15.0	1	active	I	---	-19.88	-10.67	
Att* 5 dB	EDPDCH	1920.0	1	active	I	---	-19.78	-10.56	3dB
	EDPDCH	1920.0	1	active	Q	---	-25.59	-16.38	
	EDPDCH	960.0	1	active	I	---	-19.85	-10.63	
	EDPDCH	960.0	1	active	Q	---	-27.79	-18.58	
	DPDCH	15.0	0	inactv	I	---	-60.78	-51.57	
	DPDCH	15.0	1	inactv	Q	---	-57.01	-47.79	
	DPDCH	15.0	2	inactv	I	---	-57.90	-48.68	
	DPDCH	15.0	2	inactv	I	---	-57.90	-48.68	

Figure 7-21: Channel Table of an UPLINK signal according to Release 7 specification

The following parameters of these channels are determined by the CDP measurement:

Type: Type of channel (active channels only)

Symbol Rate: Symbol rate at which the channel is transmitted (15 kbps to 960 kbps).

Chan #: Number of channel spreading code (0 to [spreading factor-1])

Status: Status display. Codes that are not assigned are marked as inactive channels.

Mapping: Component onto which the channel is mapped (I or Q). The entry is not editable, since the standard specifies the channel assignment for each channel.

PilotL: Number of pilot bits of the channel (only valid for the control channel DPCCH).

Pwr Abs / Pwr Rel:

Indication of the absolute and relative channel power (referred to the CPICH or the total power of the signal)

In *CODE CHAN AUTOSEARCH* mode, a data channel is designated as active if its power has a minimum value compared to the total power of the signal and if a minimum signal/noise ratio is maintained within the channel.

In *CODE CHAN PREDEFINED* mode, each data channel that is included in the user defined channel table is considered to be active.

Remote: CALC1:FEED "XTIM:CDP:ERR:CTAB"

FREQ ERR VS SLOT

The *FREQ ERR VS SLOT* softkey selects the new display mode of frequency error versus slot. The softkey is available in frame mode of R&S FS-K73. In slot mode of R&S FS-K73, the softkey will not appear.

To reduce the overall span of frequency error versus slot, for each value to be displayed the difference between the frequency error of the corresponding slot and the mean frequency error of the frame is calculated. This will help to eliminate a static frequency offset of the whole signal to better display a real-time-based

frequency curve.

The measurement result consists of one frequency error measurement value per slot or half slot, depending on the value of softkey *SLOT RES HALF / FULL*. For *SLOT RES FULL*, this results in a total of 15 values to be displayed for frequency error. For *SLOT RES HALF* the number of values displayed will turn to 30. The time reference for the start of slot 0 is the start of the 3GPP FDD frame.

For R&S FS-K73, the measurement is inflected by the elimination of 25 µs of tail chips at each end of the one slot (see *ELIMINATE TAIL CHIPS* softkey).

The values of *FREQ ERR VS SLOT* are displayed in Hz.

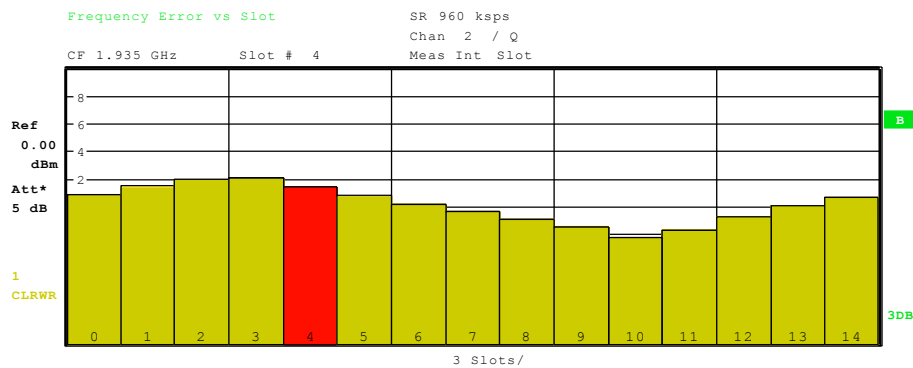

Figure 7-22: Relative frequency error versus slot

The relative frequency error $df_{rel}(i)$ is displayed versus slot. The values are given in Hz. They are referenced to the mean frequency error of the frame. In the figure above a relative frequency $df_{rel}(i)$ error with a sine shape is given. The displayed frequency error is given a:

$$df_{rel}(i) = df_{abs}(i) - \frac{1}{N} \sum_{n=0}^{N-1} df_{abs}(n) \quad | \quad i \in [0...14] \quad N = 15$$

where: $df_{rel}(i)$ [Hz] - relative frequency error for each slot
 $df_{abs}(i)$ [Hz] - absolute frequency error for each slot
 N [] - number of slots per frame

The absolute frequency error $df_{abs}(i)$ is displayed in the result summary.

Remote: CALC2:FEED "XTIM:CDP:FVSL"

PHASE DISCONT

The *PHASE DISCONT* softkey selects the new display mode of phase discontinuity versus slot. The softkey is available in frame mode of R&S FS-K73. In slot mode of R&S FS-K73, the softkey will not appear.

The phase discontinuity is calculated in accordance with 3GPP specifications. The phase calculated for each measurement interval will be interpolated to both ends of the interval using its the frequency shift. The difference between the phase interpolated for the beginning of one measurement interval and the end of the preceding measurement interval is displayed as the phase discontinuity of that interval. The measurement interval can be one full slot or one half slot, depending on the value of softkey *SLOT RES HALF / FULL*. *SLOT RES FULL* will result in a total of 15 values of phase discontinuity, *SLOT RES HALF* will give 30 values. For R&S FS-K73, the setting of the *ELIMINATE TAIL CHIPS* softkey (see *ELIMINATE*

TAIL CHIPS softkey) is taken into account

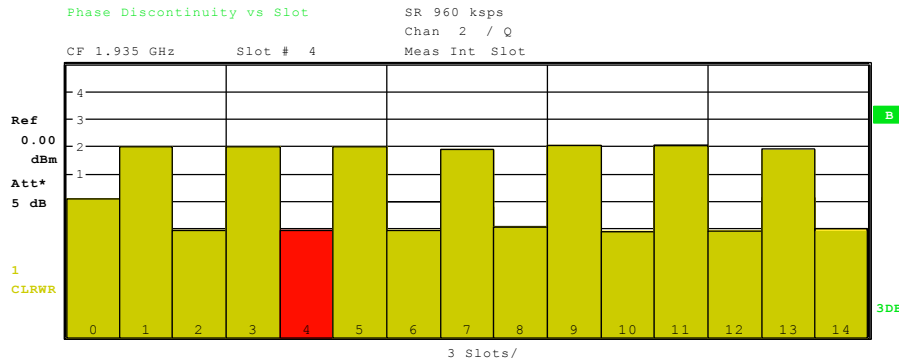

Figure 7-23 Phase discontinuity versus slot

The phase discontinuity $d\phi_{disc}(i)$ is displayed versus slot. The values of *PHASE DISCONT* are displayed in ° (deg). They are calculated by the difference of the absolute phase at the end of the previous slot [$\phi_{slot_end}(i-1)$] and the absolute phase at the beginning of the current slot [$\phi_{slot_start}(i)$] (7-23). In case of slot zero ($i=0$), the phase at the end of slot 14 of the previous frame is taken as reference. [$\phi_{slot_end}(-1) = \phi_{slot_end_prev_frame}(14)$].

In Figure 7-24 a signal with a alternating phase discontinuity of +/- 10 degree is measured.

$$d\phi_{disc}(i) = \phi_{slot_end}(i-1) - \phi_{slot_start}(i) \quad | \quad i \in [0..14]$$

- where: $d\phi_{disc}(i)$ [deg] - phase discontinuity result at the slot boarder
- $\phi_{slot_start}(i)$ [deg] - absolute phase at the start of the current slot
- $\phi_{slot_end}(i-1)$ [deg] - absolute phase at the end of the previous slot

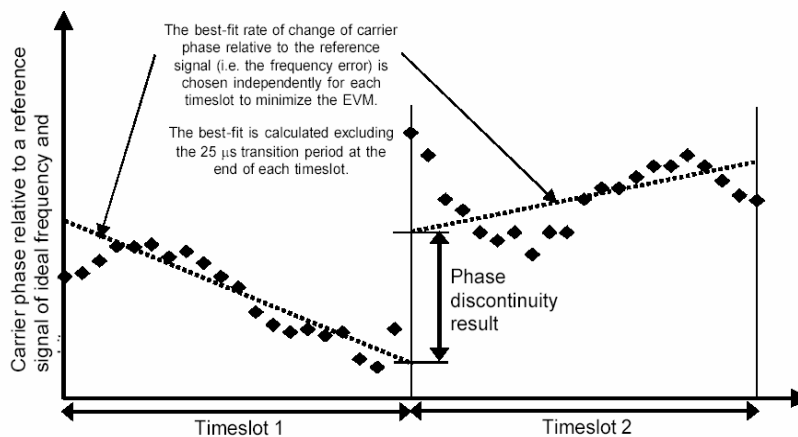

Figure 5.13.3.1 Graphical description of phase discontinuity

Figure 7-24: Measurement of phase discontinuity

Remote: CALC2:FEED ``XTIM:CDP:PVSL``

SYMBOL The *SYMBOL CONST* softkey selects the display of symbol constellation diagram.

CONST The symbols are displayed for the selected channel (red marking in the CDP diagram) and the selected slot (red marking in the power-versus-slot diagram).

The measurement interval for displaying the symbol constellation is one half slot or one full slot, depending on the value of softkey *SLOT RES HALF / FULL*.

In order to provide a better illustration of the constellation, the channel is entered in the diagram as if its constellation points would lie in the I/Q plane, i.e. channels that are mapped onto the I component have points on the real axis and channels mapped onto the Q component have points on the imaginary axis.

It is possible to display the symbol constellation for unassigned codes (red marking in the CDP diagram on a code represented in blue), but the results are not meaningful, as the unassigned code channel does not contain data.

For orientation the unit circle is shown within the diagram.

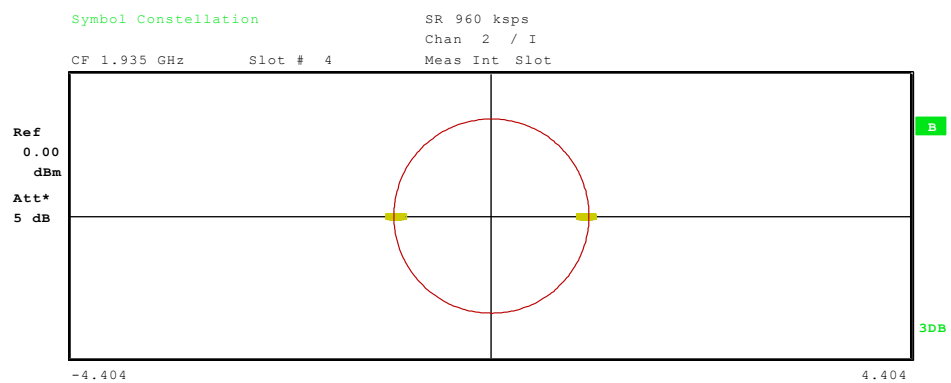

Figure 7-25: Symbol Constellation Diagram of a channel mapped onto I component

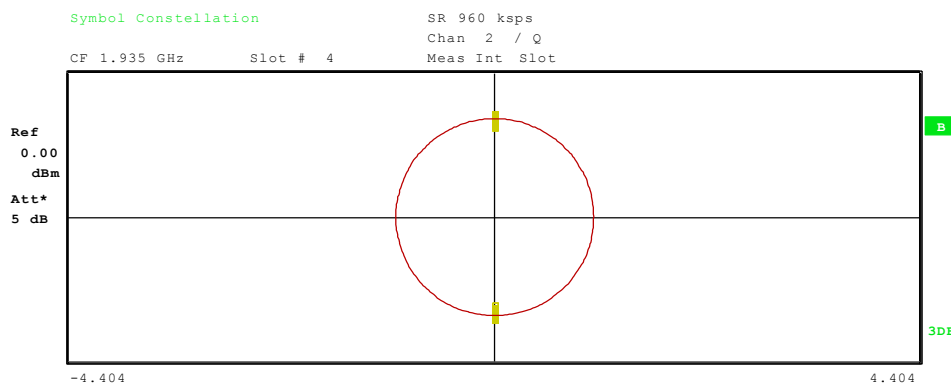
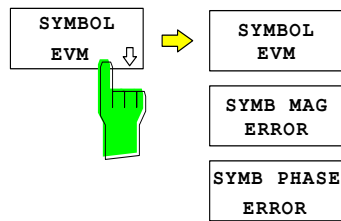

Figure 7-26: Symbol Constellation Diagram of a channel mapped onto Q component

Remote: CALC2:FEED "XTIM:CDP:SYMB:CONS"

The *SYMBOL EVM* softkey opens a submenu for symbol error vector magnitude display.



SYMBOL EVM

The *SYMBOL EVM* softkey activates the symbol error vector magnitude display. The EVM is displayed for the selected channel (red marking in the CDP diagram) and the selected slot (red marking in the power-versus-slot diagram).

The measurement interval for displaying the symbol EVM is one half slot or one full slot, depending on the value of softkey *SLOT RES HALF / FULL*.

It is possible to display the symbol error vector magnitude for unassigned codes (red marking in the CDP diagram on a code represented in blue), but the results are not valid.

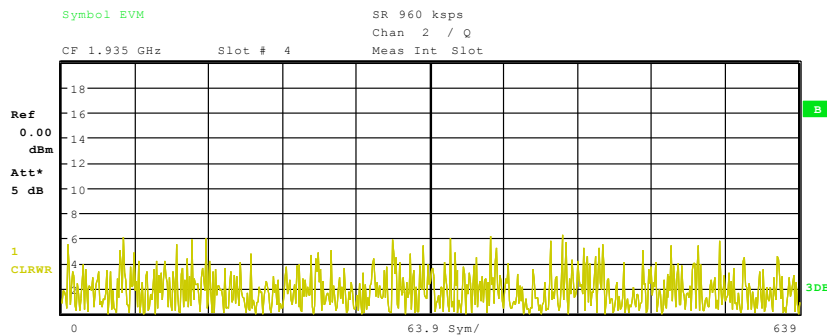

Figure 7-27: Error Vector Magnitude für einen Slot eines Kanals

Remote: CALC2:FEED "XTIM:CDP:SYMB:EVM"

SYMB MAG ERROR

The *SYMB MAG ERROR* softkey selects the new display mode of symbol magnitude error. The softkey is available in both frame and slot modes of R&S FS-K73.

The measurement interval for displaying the symbol magnitude error is one half slot or one full slot, depending on the value of softkey *SLOT RES HALF / FULL*.

The symbol magnitude error is calculated analogously to symbol EVM. The result of calculation is one symbol magnitude error value for each symbol of the slot of a special channel. Positive values of symbol magnitude error indicate a symbol magnitude that is larger than the expected ideal value; negative symbol magnitude errors indicate a symbol magnitude that is less than the ideal one.

Symbol magnitude error like symbol EVM can be calculated for both active and inactive slots of a channel. For inactive slots of a channel, however, the results are meaningless.

The values of *SYMB MAG ERROR* are displayed in %.

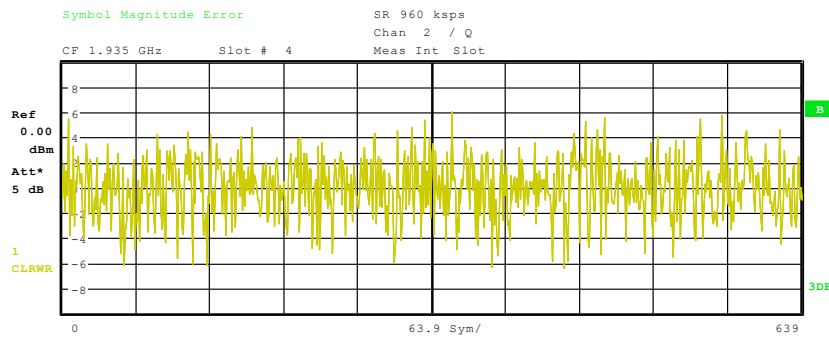

Figure 7-28: Error Vector Magnitude for the selected slot of the selected channel

```
Remote:          CALC:FEED XTIM:CDP:FVSS CALC2:FEED
                `XTIM:CDP:SYMB:EVM:MAGN`
Query of results: TRAC? TRACE2.
```

SYMB PHASE ERROR

The *SYMB PHASE ERROR* softkey selects the new display mode of symbol phase error. The softkey is available both frame and slot modes of R&S FS-K73.

The measurement interval for displaying the symbol phase error is one half slot or one full slot, depending on the value of softkey *SLOT RES HALF / FULL*.

The symbol phase error is calculated analogously to symbol EVM. The result of calculation is one symbol phase error value for each symbol of the slot of a special channel. Positive values of symbol phase error indicate a symbol phase that is larger than the expected ideal value; negative symbol phase errors indicate a symbol phase that is less than the ideal one.

Symbol phase error like symbol EVM can be calculated for both active and inactive slots of a channel. For inactive slots of a channel, however, the results are meaningless.

For R&S FS-K73, the displayed symbol phase error will always be calculated to zero. This effect is caused by the following: For R&S FS-K73, each channel is projected to one of the branches I or Q exclusively. For symbol error calculation, only the symbols spread onto this branch are taken into account. Therefore no phase difference between the measured and ideal symbols can occur. The phase error is always calculated to zero.

The values of *SYMB PHASE ERROR* are displayed in ° (deg).

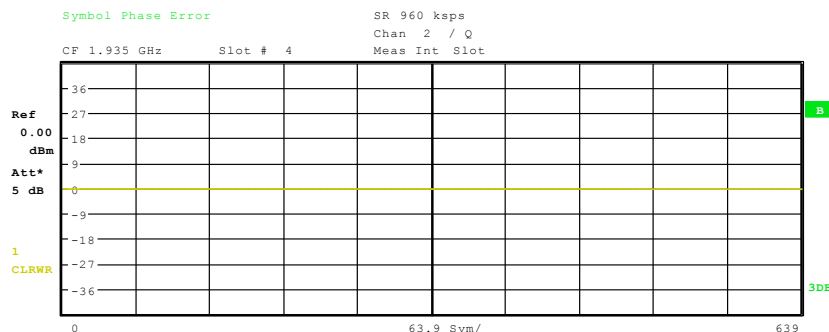

Figure 7-29: Display of symbol phase error

```
Remote: CALC2:FEED XTIM:CDP:SYMB:EVM:PHAS
```

Query of results: TRAC? TRACE2.

BITSTREAM The *BITSTREAM* softkey activates the bitstream display.

The decided bits are displayed for the selected channel (red marking in the CDP diagram) and the selected slot (red marking in the power-versus-slot diagram).

While it is possible to display the bitstream for unused codes (red marking in the CDP diagram at a code displayed in blue), the missing data means that the results are not very informative. In this case, "-" is used to indicate that all the bits are invalid.

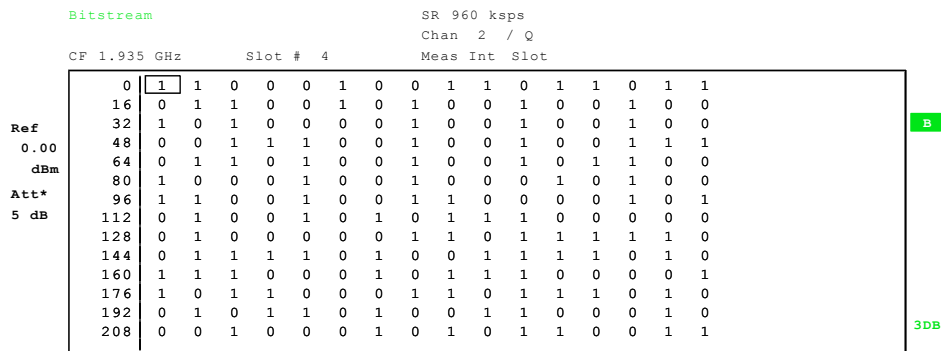

Figure 7-30: Demodulated bits for the selected slot of the selected channel

Remote: CALC2:FEED "XTIM:CDP:BSTR"

POWER VS SYMBOL

The *POWER VS SYMBOL* softkey displays the symbol power in a selected channel within a selected slot. The number of symbols depends on the code class of the selected channel and the value of the softkey *SLOT RES HALF / FULL*.

In case of *SLOT RES FULL* the number of symbols can be calculated as:

$$NOF_{Symbols} = 10 \cdot 2^{(8-CodeClass)}$$

In case of *SLOT RES HALF* it will be:

$$NOF_{Symbols} = 5 \cdot 2^{(8-CodeClass)}$$

The power curve below represents the ratio of the symbol power to the total power of the selected slot.

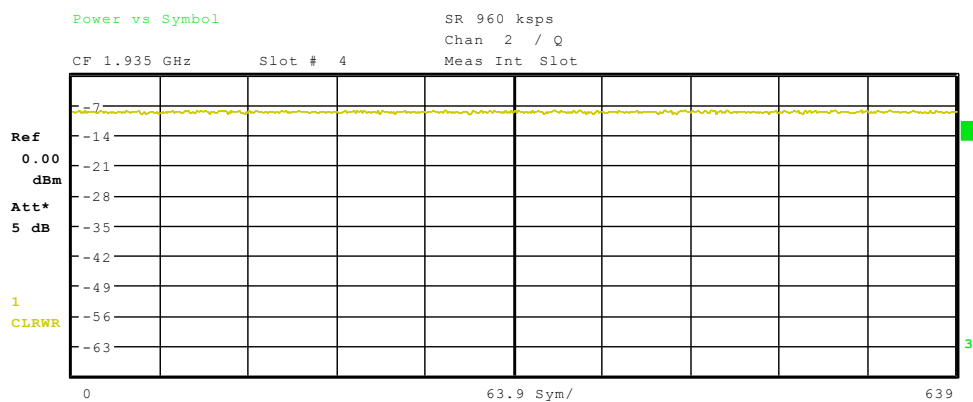

Figure 7-31: Power versus symbol for one slot of a channel with 640 symbols

Remote: CALC1:FEED "XTIM:CDP:PVSY"
 Query of results: TRAC1:DATA2 TRACE2
 Output: List of symbol power values deviating from the reference power
 Format: Val₁,Val₂,..., Val_{NOF}
 Unit: [dB]
 Quantity: $NOF_{Symbols} = 10 \cdot 2^{(8-CodeClass)}$ for SLOT RES FULL
 $NOF_{Symbols} = 5 \cdot 2^{(8-CodeClass)}$ for SLOT RES HALF

SELECT I/Q

The *SELECT I/Q* softkey switches the display modes *CDP PWR RELATIVE/ABSOLUTE*, *CODE PWR ZOOM*, *POWER VS SLOT*, *SYMBOL CONST*, *SYMBOL EVM* between indication of I and Q component. Only channels that are mapped onto the corresponding component are taken into account by the respective display modes.

Remote: SENS:CDP:MAPP Q

SELECT CHANNEL

The *SELECT CHANNEL* softkey activates the selection of a channel for the display modes *CDP PWR RELATIVE/ABSOLUTE*, *POWER VS SLOT*, *SYMBOL CONST*, *SYMBOL EVM*.

There are two ways of entering the channel numbers:

- Entry of channel number and spreading factor, separated by a decimal point

If the channel number and the spreading factor are entered simultaneously, the entered channel is selected and marked in red if an active channel is concerned. For the display, the channel number entered is converted on the basis of spreading factor 256. For unused channels, the code resulting from the conversion is marked.

Example: Entry 2.4

Channel 2 is marked at spreading factor 4 (960 kbps) if the channel is active, otherwise code 128 at spreading factor 256.

- Entry of a channel number without a decimal point

In this case, R&S FS-K73 interprets the entered code as based on spreading factor 256. If the code entered corresponds to a used channel, the whole associated channel is marked. If the code corresponds to an unused channel, only the code entered is marked.

Example: Entry 128

Code 128 is marked at spreading factor 256 if there is no active channel on this code. If for instance channel 2 is active at spreading factor 4, the entire channel 2 is marked.

If the entered code corresponds to an active channel, the whole associated channel is marked. If it corresponds to a gap between the channels, only the entered code is marked. If the code number is modified using the roll key, the red marking changes its position in the diagram only if the code number no longer belongs to the marked channel. The step width of the changed roll key position refers to spreading factor 256.

Remote: SENS:CDP:CODE 0...255

The *SELECT* softkey opens a submenu special parameters of analysis.

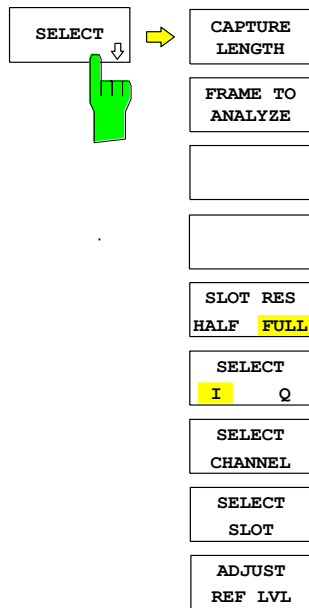

CAPTURE LENGTH

The softkey *CAPTURE LENGTH* enables an entry window for determining the number of frames that are to be captured at each sweep.

Remote: SENS:CDP:IQL <numeric value>

Range: R&S FSU / FSP-B70 (*free run*): <numeric value> [1 ... 2]

R&S FSU / FSP-B70 (*ext. Trig*): <numeric value> [1 ... 3]

R&S FSQ: <numeric value> [1 ... 100]

R&S FSMR (*free run*): <numeric value> [1 ... 2]

Unit: <numeric value> [0 ... CAPTURE_LENGTH - 1]

FRAME TO ANALYZE

The softkey *FRAME TO ANALYZE* enables an entry window for selecting the frame number to be analyzed.

Remote: SENS:CDP:FRAM:VAL <numeric value>

Range: <numeric value> [0 ... CAPTURE_LENGTH - 1]

SLOT RES HALF / FULL The *SLOT RES HALF / FULL* softkey switches the R&S FS-K73 between the analysis of one half and one full slot.

In case of *SLOT RES FULL* the length of each analysis interval will be 2560 chips, corresponding to one time slot of the 3GPP signal. The time reference for the start of slot 0 is the start of a 3GPP radio frame.

In case of *SLOT RES HALF* the length of each analysis interval is reduced to 1280 chips, corresponding to the half of one time slot of the 3GPP signal. The softkey *SELECT SLOT* switches its caption to *SELECT HALF SLOT* and via the keys half slot numbers can be entered. The time reference for the start of half slot 0 remains the same as above: the start of one radio frame of 3GPP signal.

Both measurement intervals are influenced by the softkey *ELIMINATE TAIL CHIPS*: If *ELIMINATE TAIL CHIPS* is selected, 96 chips at both ends of the measurement interval are not taken into account for analysis.

Remote: SENS:CDP:HSL ON | OFF

SELECT SLOT The softkey *SELECT SLOT* activates the selection of the slot number for the display modes POWER VS SLOT, SYMBOL CONST, SYMBOL EVM. The softkey is only valid if one frame of the 3GPP signal is analyzed.

The caption of the softkey is influenced by softkey SLOT RES HALF / FULL: At SLOT RES HALF the caption will change to SELECT HALF SLOT and the range of entries will be 0 to 29 instead SELECT SLOT and 0 to 14 in case of SLOT RES FULL.

When the slot number is entered, the red marking in the power-versus-slot diagram changes its position in steps of a slot.

Remote: SENS:CDP:SLOT 0 ... 14

ADJUST REF LVL The *ADJUST REF LVL* softkey adjusts the reference level of the analyzer to the measured channel power. This ensures that the settings of the RF attenuation and the reference level are optimally adjusted to the signal level without overloading the instrument or limiting the dynamic range by a too small S/N ratio.

Remote: SENS:POW:ACH:PRES:RLEV

7.5.2 Measurement Configuration –*CHAN CONF* hotkey

Hotkey *CHAN CONF*

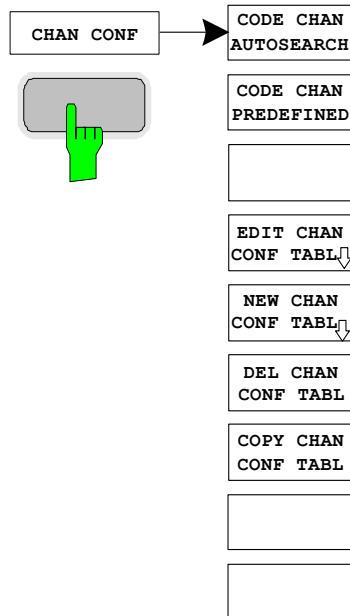

The *CHAN CONF* hotkey opens a submenu with different configurations for measurements. In this submenu, predefined channel tables can be selected as a basis for code domain measurements.

When the hotkey is selected, a table including the channel tables stored on the measuring instrument's hard disk is opened. The table provides just an overview and a table for the measurement can only be selected after actuating the *CODE CHAN PREDEFINED* softkey.

Remote: CONF:WCDP:MS:CTABL:CAT?

CODE CHAN AUTOSEARCH

The *CODE CHAN AUTOSEARCH* softkey allows code domain power measurements in the automatic search mode. In this mode, the whole code domain (all permissible symbol rates and channel numbers) is searched for active channels. The channel search is based on a comparison of the powers of active channels and unused codes. Furthermore, the restrictions in channel configuration given by the 3GPP specifications are taken into account.

The synchronization channel DPCCH is assumed to be present in the signal by the CDP analysis and added to the channel table for each measurement.

The *CODE CHAN AUTOSEARCH* mode is the preset search mode when starting the CDP analysis. It is mainly intended for giving the user an overview of the channels contained in the signal. If the signal contains channels that are not detected as being active in the automatic search mode, the CDP analysis can be performed with the channel configurations predefined by the user by switching to the *CODE CHAN PREDEFINED* mode.

Remote: CONF:WCDP:MS:CTAB:STAT OFF

CODE CHAN PREDEFINED

The *CODE CHAN PREDEFINED* softkey activates the predefined channel table mode. No search for active channels in the code domain is performed in this mode, but the channels contained in a channel table defined prior to the measurement are assumed to be active.

The code domain power measurement and all further evaluations are carried out for these channels.

On selecting the softkey, a table containing all channel tables stored in the measuring instrument is opened. The CDP analysis is switched to the mode "predefined channel table". When the next measurement is started, the power is measured according to this mode. The last table of the automatic search mode is first taken as a basis for the measurement. This table is available under the *RECENT* entry.

Switching to one of the predefined channel tables is done by selecting the corresponding table entry and pressing one of the unit keys. From the next measurement onwards, the selected channel table is taken as a basis for the sweep. A tick marks the selected channel table.

```
Remote:          CONF:WCDP:MS:CTAB:STAT ON
                CONF:WCDP:MS:CTAB:SEL "CTAB 1"
```

The *EDIT CHAN CONF TABLE* softkey opens a channel table in which the user can edit the channel configuration. In addition, a submenu is opened giving access to the softkeys required for editing the table.

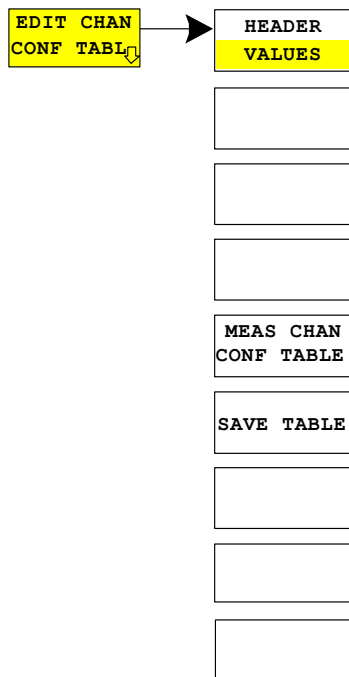

EDIT CHANNEL TABLE						
NAME:		RECENT				
COMMENT:		generated by WCDMA				
CHANNEL	SYMBOL	CHAN #	MAPPING	PILOT	CDP REL.	STATUS
TYPE	RATE [kpsps]			BITS	[dB]	
DPCCH	15	0	Q	8	-2.1724	ACTIVE
HSDPCCH	15	33	Q	---	-18.2233	ACTIVE
EDPCCH	15	1	I	---	-11.2132	ACTIVE
DPDCH	15	64	I	---	-11.1898	INACTIVE
DPDCH	960	1	Q	---	-11.2218	INACTIVE
DPDCH	960	3	I	---	-11.2101	INACTIVE
DPDCH	960	3	Q	---	-11.2114	INACTIVE
DPDCH	15	0	I	---	-59.9371	INACTIVE
DPDCH	15	1	Q	---	-63.2550	INACTIVE
EDPDCH	1920	1	I	---	-11.1898	ACTIVE
EDPDCH	1920	1	Q	---	-11.2218	ACTIVE
EDPDCH	960	1	I	---	-11.2101	ACTIVE
EDPDCH	960	1	Q	---	-11.2114	ACTIVE

Figure 7-32: Table for editing a channel configuration

Basically, any channel table stored on the instrument's hard disk can be edited as required. An edited table is not stored automatically but only after pressing the *SAVE TABLE* softkey. This prevents inadvertent overwriting of a table.

If the user edits the table currently used in CDP analysis, the edited table is taken as a basis for the next measurement immediately after it is stored. The effects of modifications made to the table show, therefore, at once. Here, too, the *SAVE TABLE* softkey must be pressed to store the edited table on the instrument's hard disk.

If the user edits a table stored on the hard disk but currently not active, the modifications become visible only after storage (*SAVE TABLE* softkey) and subsequent activation.

Remote: CONF:WCDP:MS:CTAB:EDAT

HEADER VALUES

The *HEADER/VALUES* softkey switches between editing the channel table header or its values.

HEADER allows editing the table header, i.e. the name and the comment. By changing the table name, overwriting of a table already stored is prevented. The table name may contain max. 8 characters.

Remote: CONF:WCDP:MS:CTAB:NAME "NEW_TAB"

VALUES allows editing the entries in a channel table. The following parameters are available for each channel of a table (confirm each entry with one of the unit keys):

SYMBOL RATE: Symbol rate at which a channel is transmitted. This entry can only be edited if one data channel is used within the channel configuration.

CHAN#: Number of channel in the associated transmission class. For the channel numbers are fixed for all channel configurations of 3GPP uplink, the entry is not editable. The channel numbers will be set automatically according to the specifications.

MAPPING: I or Q component the channel is projected onto. The entry is not editable since the component the channel should be projected onto is fixed in 3GPP specifications for each channel.

PILOT BITS: Number of pilot bits of a channel. The entry is editable for the DPCCH only.

CDP REL.: Information about relative channel power. This entry cannot be edited and exists only for the *RECENT* table; it is used for indicating low-

power channels.

STATUS: Channel status (active/inactive). Setting the channel status to inactive excludes a channel entered in the table from CDP analysis without the complete channel line having to be cleared from the table. Only channels with an active status are taken into account in CDP analysis. By activating/deactivating a channel the analysis is switched between the one-data-channel-model and the multiple-data-channel-model. At the model with more than one data channel, the channel configurations will be set according to the 3GPP specifications.

Remote: CONF:WCDP:MS:CTAB:DATA 8,4,1
 CONF:WCDP:MS:CTAB:COMM "Comment for new table"

**MEAS CHAN
 CONF TABLE**

The *MEAS CHAN CONF TABLE* softkey starts a measurement in the *CODE CHAN AUTOSEARCH* mode. The measurement results are entered in the channel table currently open. This softkey is available only in the *CODE CHAN AUTOSEARCH* mode.

Remote: --

SAVE TABLE

The *SAVE TABLE* softkey saves the table under the specified name.

Note:

Editing a channel model and storing it under its original name will overwrite the model!

Remote: -- (automatic storage with remote control)

The *NEW CHAN CONF TABLE* softkey opens a submenu identical to that opened by the *EDIT CHAN CONF TABLE* softkey. In contrast to *EDIT CHAN CONF TABLE*, *NEW CHAN CONF TABLE* opens a table in which only the control channel is entered; the table name is not yet defined.

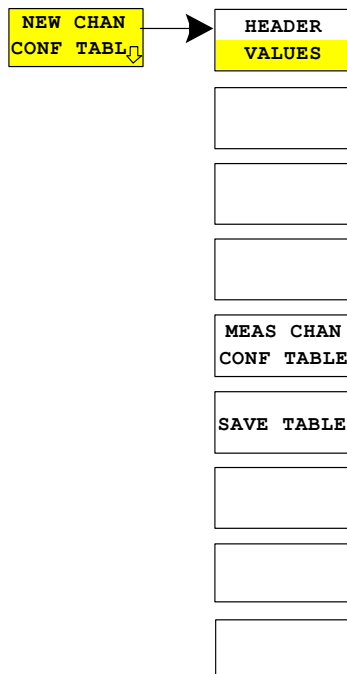

EDIT CHANNEL TABLE						
NAME:	default					
COMMENT:	default					
SYMBOL RATE [kspa]	CHAN #			PILOT BITS	CDP REL. [dB]	STATUS
DPCCH	0	Q		8	0.0000	ACTIVE
15	64	I		---	0.0000	ACTIVE
960	1	Q		---	0.0000	INACTIVE
960	3	I		---	0.0000	INACTIVE
960	3	Q		---	0.0000	INACTIVE
960	2	I		---	0.0000	INACTIVE
960	2	Q		---	0.0000	INACTIVE

Figure 7-33: Creating a new channel configuration

**DEL CHAN
CONF TABLE**

The *DEL CHAN CONF TABLE* softkey deletes a selected table from the list. The currently active table in the *CODE CHAN PREDEFINED* mode cannot be deleted.

Remote: CONF:WCDP:MS:CTAB:DEL

**COPY CHAN
CONF TABLE**

The *COPY CHAN CONF TABLE* softkey copies a selected table. The user is queried to enter the name under which the copy is to be saved.

Remote: CONF:WCDP:MS:CTAB:COPY "CTAB2"

7.5.3 Configuration of CDP Measurement – SETTINGS hotkey

The *SETTINGS* hotkey opens a submenu with softkeys for setting parameters for the CDP measurement.

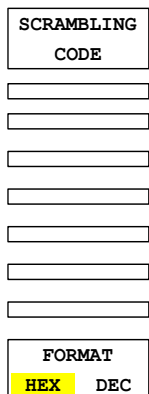
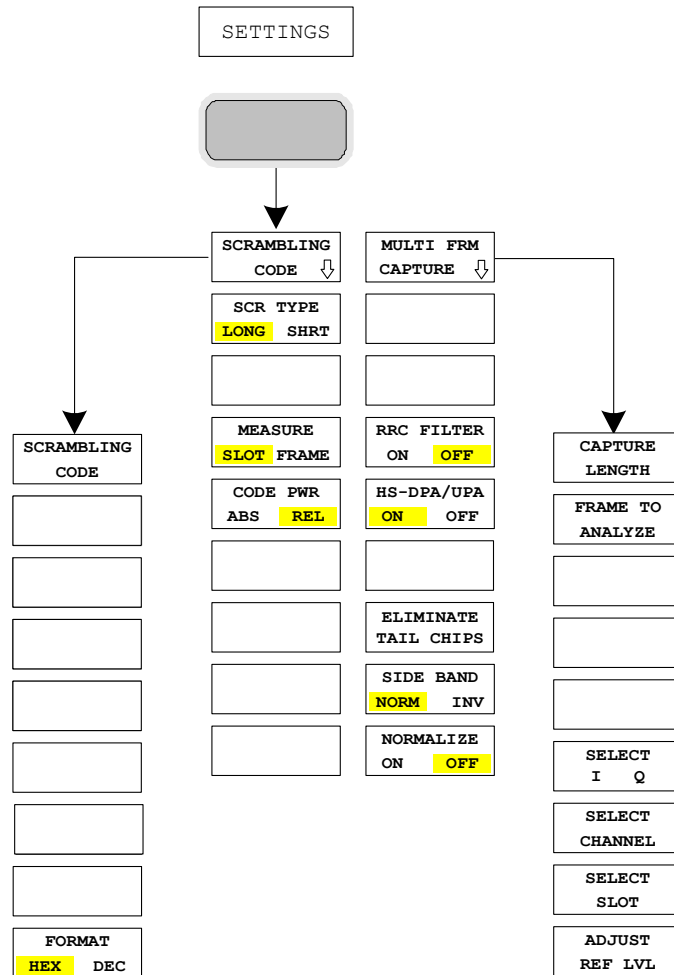

The *SCRAMBLING CODE* softkey opens a window for entering the scrambling code. The scrambling code is input in hex format.

The entered scrambling code has to coincide with that of the signal. Otherwise a CDP measurement of the signal is not possible.

Remote: SENS:CDP:LCOD:VAL #H2

FORMAT HEX / DEC	<p>The format for the entry of the <i>SCRAMBLING CODE</i> can be specified. With the <i>FORMAT HEX / DEC</i> softkey, either hexadecimal or decimal can be selected. Default is hexadecimal.</p> <p>Remote: SCRAMBLING CODE HEX (herkömmlicher Befehl) SENS:CDPower:LCOD:VAL <hex> SCRAMBLING CODE DEC SENS:CDP:LCOD:DVAL <numeric_value></p>
SCR TYPE LONG / SHRT	<p>The <i>SCR TYPE LONG / SHRT</i> softkey determines whether the scrambling code entered (see softkey <i>SCRAMBLING CODE</i>) is to be handled as long or short scrambling code.</p> <p>Remote: :SENS:CDP:LCOD:TYPE SHOR</p>
MEASURE SLOT / FRAME	<p>The <i>MEASURE SLOT / FRAME</i> softkey switches between a result length of one slot and one complete frame. The softkey is only valid, if the spectrum analyzer R&S FSU or R&S FSQ is used. For spectrum analyzer R&S FSP, a fixed result length of one slot is used.</p> <p>Remote: SENS:CDP:BASE SLOT FRAME</p>
CODE PWR ABS / REL	<p>The <i>CODE PWR ABS / REL</i> softkey toggles the display mode of the code domain power display (see <i>CODE DOM POWER</i>). If the power versus slot measurement is active, the slot power is indicated in absolute or relative values.</p> <p>REL: Selects relative scaling of the CDP measurement. The power is referenced to the total power of the selected slot. The values are displayed in dB (default settings).</p> <p>ABS: Selects an absolute scaling of the CDP measurement. The values are displayed in dBm.</p> <p>Remote:</p> <p>Rel. Scaling: CALC1:FEED "XPOW:CDP:RAT" Abs. Scaling: CALC1:FEED "XPOW:CDP" CALC1:FEED "XPOW:CDP:ABS" CALC1:FEED "XTIM:CDP:PVSL:ABS" CALC1:FEED "XTIM:CDP:PVSL:RAT"</p>

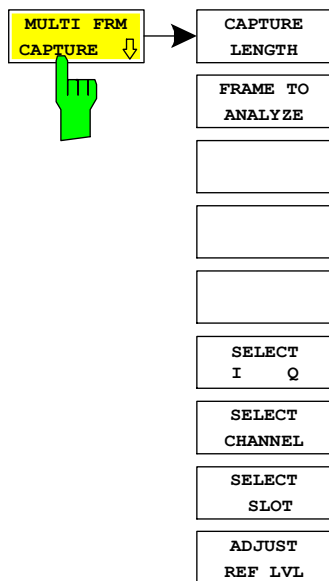

The Softkey *MULTI FRM CAPTURE* opens a submenu for specifying the parameters for multi-frame measurement. This measurement supports the data acquisition and evaluation of more than one 3GPP WCDMA frame. Depending on the analyser type that is used, several frames can be captured and evaluated.

The following figure shows the memory structure of the captured data. The size of the stored data depends on the parameter *CAPTURE LENGTH*, which defines the number of frames that are captured after a sweep is forced. If the parameter *CAPTURE LENGTH* has been changed, a new sweep must be started (*SINGLE SWEEP*) or must have been finished (*CONTINUOUS SWEEP*) in order to obtain valid measurement results for the specified range. The maximum number of storable frames depends on the trigger mode (*FREE RUN* or *EXT TRIG*). By changing the parameter *FRAME TO ANALYZE*, the frame number to be analyzed can be selected. The displayed results are refreshed if *FRAME TO ANALYZE* has been changed or a new sweep is started.

The *TRIGGER TO FRAME* time (TTF) is measured from the external trigger event to the start of the selected frame (*FRAME TO ANALYZE*). Therefore, the TTF of frame 0 is usually smaller than one slot (<667 us). If frame 1 is selected, the displayed TTF is between 10 ms and 10.667 ms. The TTF time is displayed in the result summary. For the TTF time of frame n , the following equation is used:

$$TTF_n = TTF_0 + n \cdot 10 \text{ ms}$$

The maximum number of captured frames depends on the memory size and the trigger mode.

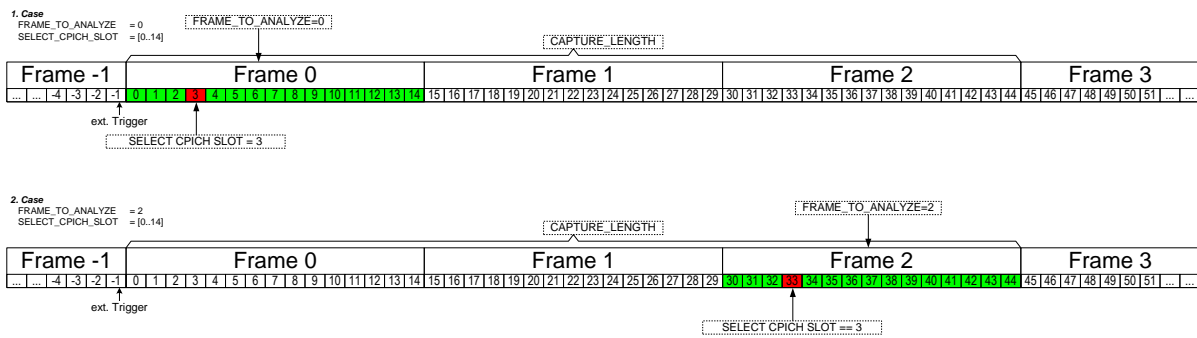

Figure 7-34: Data scheme of the captured and analyzed frames

Maximum number of captured frames:

Analyzer	Downlink (K72/K74) EXT TRIGGER	Downlink (K72/K74) FREE RUN	Uplink (K73) EXT TRIGGER	Downlink (K73) FREE RUN
R&S FSP	---	---	1 Slot	1 Slot
R&S FSP (B70)	3 Frames	2 Frames	3 Frames	2 Frames
R&S FSU	3 Frames	2 Frames	3 Frames	2 Frames
R&S FSQ	100 Frames	100 Frames	100 Frames	100 Frames



The SELECT I/Q, SELECT CHANNEL and ADJUST REF LVL softkeys are described on page 76.

CAPTURE LENGTH

The softkey *CAPTURE LENGTH* enables an entry window for determining the number of frames that are to be captured at each sweep.

Remote: SENS:CDP:IQL <numeric value>

Range: R&S FSU / R&S FSP-B70 (free run): <numeric value> [1 ... 2]

R&S FSU / R&S FSP-B70 (ext. Trig): <numeric value> [1 ... 3]

R&S FSQ: <numeric value> [1 ... 100]

Unit: [Frames]

FRAME TO ANALYZE

The softkey *FRAME TO ANALYZE* enables an entry window for selecting the frame number to be analyzed.

Remote: SENS:CDP:FRAM:VAL <numeric value>

Range: <numeric value> [0 ... CAPTURE_LENGTH - 1]

Unit: [Frames]

Default: 0

- RRC FILTER ON / OFF** The *RRC FILTER ON / OFF* softkey selects if a root raised cosine (RRC) receiver filter is used or not. This feature is useful if the RRC filter is implemented in the device under test (DUT).
- ON: If an unfiltered WCDMA signal is received (normal case), the RRC filter should be used to get a correct signal demodulation. (Default settings).
- OFF: If a filtered WCDMA signal is received, the RRC filter should not be used to get a correct signal demodulation. This is the case if the DUT filters the signal.
- Remote: SENS:CDP:FILT ON|OFF
- HS-DPA/UPA ON / OFF** The *HS-DPA/UPA ON / OFF* softkey selects if the HS-DPCCH, E-DPCCH and E-DPDCH channels are displayed or not.
- ON: If an unfiltered WCDMA signal is received (normal case), the RRC filter should be used to get a correct signal demodulation. (Default settings).
- OFF: If a filtered WCDMA signal is received, the RRC filter should not be used to get a correct signal demodulation. This is the case if the DUT filters the signal.
- Remote: SENS:CDP:HSDP ON|OFF
CONF:WCDP:MS:CTAB:DATA:HSDP ON|OFF
- ELIMINATE TAIL CHIPS** The *ELIMINATE TAIL CHIPS* selects length of the measurement interval for calculation of error vector magnitude (EVM). In accordance with 3GPP specification Release 5, the EVM measurement interval is one slot (4096 chips) minus 25 μ s at each end of the burst (3904 chips) if power changes are expected. If no power changes are expected, the evaluation length is one slot (4096 chips).
- ON: Changes of power are expected. Therefore an EVM measurement interval of one slot minus 25 μ s (3904 chips) is considered.
- OFF: Changes of power are not expected. Therefore an EVM measurement interval of one slot (4096 chips) is considered. (Default settings).
- Remote: SENS:CDP:ETCH ON|OFF
- SIDE BAND NORM / INV** The *SIDE BAND NORM / INV* softkey is used to perform the measurement both in the normal (NORM) and inverted position (INV).
- NORM The normal position allows the measurement of RF signals from the user equipment.
- INV The inverted position is useful for measurements on IF modules or components in case of spectral inversion.
- Remote: SENS:CDP:SBAN NORM|INV
- NORMALIZE ON / OFF** The *NORMALIZE ON / OFF* softkey eliminates the DC offset of the signal (see entry "IQ offset" of RESULT SUMMARY) display. In case K73+ key is installed on the analyzer, the DC offset is measured together with all other relevant parameters that describe the in-channel quality of the signal in a single measurement process. If the key is not installed, the DC offset is measured together with IQ imbalance beside the in-channel measurement.
- Remote: SENS:CDP:NORM OFF

7.5.4 Frequenz-Einstellung – Key *FREQ*

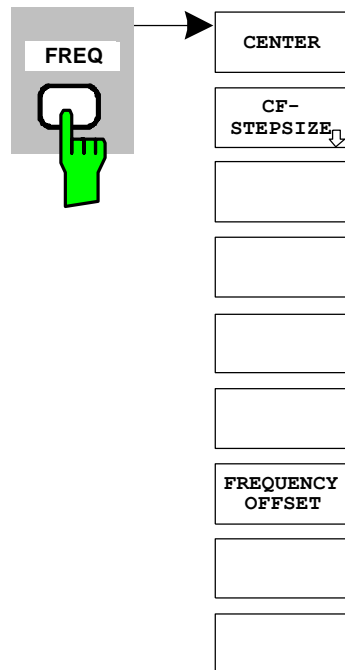

The *FREQ* key opens a submenu for changing the measurement frequency.

The *CENTER* softkey opens the window for manually entering the center frequency.

The allowed range of values for the center frequency is:

$$\text{Minspan}/2 \leq f_{\text{center}} \leq f_{\text{max}} - \text{Minspan}/2$$

f_{center}	center frequency
Minspan	smallest selectable span >0 Hz (10Hz)
f_{max}	max. frequency

Remote: `FREQ:CENT 100MHz`

The *CF STEPSIZE* softkey opens a submenu for setting the step size of the center frequency. The step size can be coupled to the span (frequency domain) or the resolution bandwidth (time domain) or it can be manually set to a fixed value. The softkeys are mutually exclusive selection keys.

The *FREQUENCY OFFSET* softkey activates the window for entering an arithmetical frequency offset which is added to the frequency axis labeling. The allowed range of values for the offset is -100 GHz to 100 GHz. The default setting is 0 Hz.

Remote: `FREQ:OFFS 10 MHz`

CF STEPSIZE The center frequency can be adjusted either by typing in the carrier frequency or by using the up and down keys or the rotary knob. The step size can be set, e.g. to a carrier spacing in multicarrier measurements. With the *CF STEPSIZE* softkey, a submenu with the *MANUAL* softkey is available. The default value of 10 Hz can be adjusted.

MANUAL

Remote: SENS:FREQ:CENT:STEP 15 Hz

7.5.5 Span Settings – Key *SPAN*

The *SPAN* key is disabled for measurements in the CDP mode. For all other measurements (see *MEAS* key), the permissible span settings are described with the relevant measurement. The associated menu corresponds to that of the measurement in the basic unit and is described in the manual of the basic unit.

7.5.6 Level Settings – Key *AMPT*

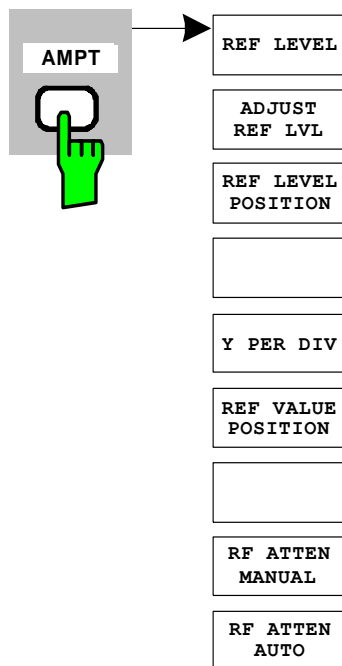

The *AMPT* key opens a submenu for level setting.

The *REF LEVEL* softkey allows the reference level to be input in the currently active unit (dBm, dB μ V, etc).

Remote: :DISP:WIND:TRAC:Y:RLEV -60dBm

ADJUST REF LVL executes a routine for optimum adjustment of the reference level to the signal.

Remote: SENS1|2:CDP:LEV:ADJ

The *REF LEVEL OFFSET* softkey allows the arithmetic level offset to be entered. This offset is added to the measured level irrespective of the selected unit. The scaling of the Y-axis is changed accordingly.

The setting range is ± 200 dB in 0.1 dB steps.

Remote: `DISP:WIND:TRAC:Y:RLEV:OFFS -10dB`

Y PER DIV determines the grid spacing on the Y axis for all diagrams, where possible.

Remote: `DISP:WIND1|2:TRAC1:Y:SCAL:PDIV`

REF VALUE POSITION allows entry of the position of the reference value on the Y axis (0 – 100%).

Remote: `DISP:WIND1|2:TRAC1:Y:SCAL:RPOS`

The *RF ATTEN MANUAL* softkey allows the attenuation to be entered irrespective of the reference level.

If the defined reference level cannot be set for the given RF attenuation, the reference level will be adjusted accordingly and the warning "Limit reached" will be output.

Remote: `INP:ATT 40 DB`

The *RF ATTEN AUTO* softkey sets the RF attenuation automatically as a function of the selected reference level.

This ensures that the optimum RF attenuation desired by the user is always used.

RF ATTEN AUTO is the default setting.

Remote: `INP:ATT:AUTO ON`

7.5.7 Marker Settings – Key *MKR*

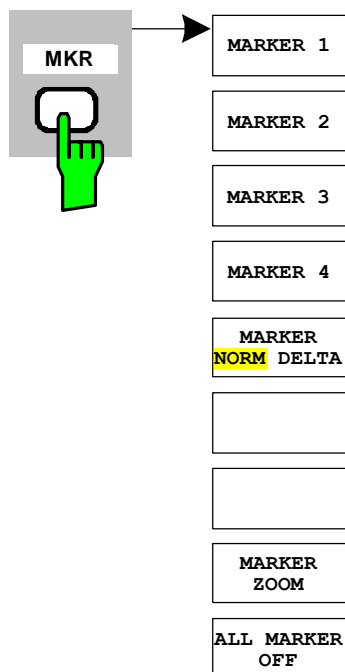

The *MARKER* key opens a submenu for the marker settings.

Markers are not available for the *RESULT SUMMARY* and *CHANNEL TABLE* displays. In all other displays, up to four markers can be activated, which can be defined as marker or delta marker by means of the *MARKER NORM/DELTA* softkey. The *MARKER 1/2/3/4* softkey selects the corresponding marker and activates it.

MARKER 1 is always the normal marker. After they have been switched on, *MARKERS 2 to 4* are delta markers that refer to *MARKER 1*. These markers can be converted into markers with absolute value display by means of the *MARKER NORM DELTA* softkey. When *MARKER 1* is the active marker, pressing the *MARKER NORM DELTA* softkey switches on an additional delta marker.

Pressing the *MARKER 1 to 4* softkey again switches off the selected marker.

```
Remote: CALC:MARK ON;
        CALC:MARK:X <value>;
        CALC:MARK:Y?
        CALC:DELT ON;
        CALC:DELT:MODE ABS|REL
        CALC:DELT:X <value>;
        CALC:DELT:X:REL?
        CALC:DELT:Y?
```

The *MARKER ZOOM* softkey expands the area around *MARKER 1*. With the zoom function, more details of the display can be seen.

If *MARKER 1* is not active when the softkey is pressed, it is automatically activated and set to the highest peak in the window.

If an instrument setting is changed after selection of *MARKER ZOOM*, the function is aborted

```
Remote: CALC:MARK:FUNC:ZOOM
```

The *ALL MARKER OFF* softkey switches off all markers (reference and delta markers). It also switches off all functions and displays associated with the markers/delta markers.

```
Remote: CALC:MARK:AOFF
```

The parameters concerning an activated marker are output at the top of the diagram:

```
Marker 1 [T1 ]
                                     -6.02 dBm
Slot 4 SR 960.0 kspS Ch 2
```

Figure 7-35: Parameters of the marker info field

Besides the channel power, the parameters are:

Slot 4: Slot number of the channel
 SR 960 kspS: Symbol rate of the channel (unassigned codes 15 kspS)
 Ch 2: Number of the spreading code of the channel

For all other measurements, the marker functions of the basic unit apply.

7.5.8 Changing Instrument Settings – Key *MKR*→

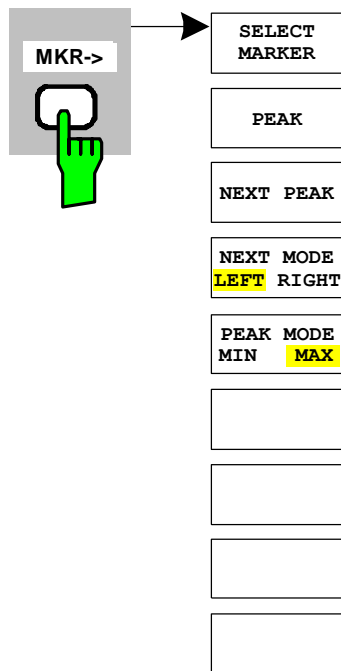

The *MKR*→ key opens a submenu for marker functions:

The *SELECT MARKER* softkey activates the numerical selection of the marker in the data entry field. Delta marker 1 is selected by input of '0'.

```
Remote: CALC:MARK1 ON;
        CALC:MARK1:X <value>;
        CALC:MARK1:Y?
```

The *PEAK* softkey sets the active marker or delta marker to the peak of the trace.

If no marker is active when *MKR*-> menu is called, *MARKER 1* is automatically switched on and the peak search is performed.

```
Remote: CALC:MARK:MAX
        CALC:DELT:MAX
        CALC:MARK:MIN
        CALC:DELT:MIN
```

The *NEXT PEAK* softkey sets the active marker/delta marker to the next lower peak value on the trace. The search direction is defined in the *NEXT MODE* submenu (see below).

```
Remote: CALC:MARK:MAX:NEXT
        CALC:DELT:MAX:NEXT
        CALC:MARK:MIN:NEXT
        CALC:DELT:MIN:NEXT
```

The *NEXT MODE LEFT/RIGHT* softkey defines the searching direction for the search of the next maximum/minimum. For *NEXT MODE LEFT/RIGHT* the next extreme is searched to the left/right of the active marker.

```

Remote:  CALC:MARK:MAX:LEFT
         CALC:DELT:MAX:LEFT
         CALC:MARK:MIN:LEFT
         CALC:DELT:MIN:LEFT
         CALC:MARK:MAX:RIGH
         CALC:DELT:MAX:RIGH
         CALC:MARK:MIN:RIGH
         CALC:DELT:MIN:RIGH

```

The *PEAK MODE MIN/MAX* softkey defines whether the peak should be searched in minima or maxima. This parameter influences the behaviour of the softkeys *PEAK* and *NEXT PEAK*.

```
Remote: --
```

7.5.9 Marker Functions – Key *MKR FCTN*

The *MKR FCTN* key is disabled for all measurements in the code domain power. For all other R&S FS-K73 measurements, the menu softkeys are described in the manual of the basic unit.

7.5.10 Bandwidth Setting – Key *BW*

The *BW* key is disabled for all measurements in the code domain power. For all other R&S FS-K73 measurements, the menu-specific softkeys are described in the manual of the basic unit.

7.5.11 Measurement Control – Key *SWEEP*

The menu of the *SWEEP* key contains options for switchover between single measurement and continuous measurement and for the control of individual measurements. For measurements within the spectrum, the measurement time for a sweep can also be set. All menu-specific softkeys are described in the manual of the basic unit.

7.5.12 Measurement Selection – Key *MEAS*

The menu of the *MEAS* key contains all the R&S FS-K73 measurements, which can be selected at a keystroke. The menu and its submenus are described in chapter 6.

7.5.13 Trigger Settings – Key *TRIG*

The selectable trigger functions depend on the measurement selected. Code domain power measurements allow the free run mode as well as the frame trigger mode specified by the 3GPP standard. For all other measurements, the trigger modes are identical to those of the corresponding measurement in the basic unit. The associated softkeys are described in the manual of the basic unit.

EXTERN With the *TRIGGER EXTERN* softkey the external trigger source can be selected. The external trigger level can be adjusted in the range from 0.5V to 3.5V. The default value is 1.4 V.

Remote: TRIG:SEQ:LEV:EXT 1.4V

Read trigger level:

TRIG1:SEQ:LEV:EXT?

Activate external Trigger Mode:

TRIG1:SEQ:SOUR EXT

Activate external Trigger Mode:

TRIG1:SEQ:SOUR IMM

7.5.14 Trace-Einstellungen – Key *TRACE*

Die Key *TRACE* öffnet folgendes Untermenü:

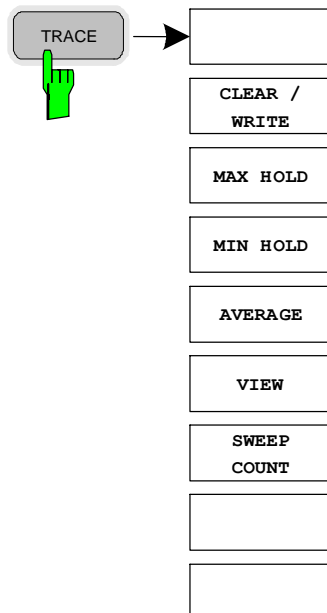

The Key *TRACE* opens the following submenu:

The *CLEAR/WRITE* softkey activates the overwrite mode for the collected measured values, i.e. the trace is overwritten by each sweep.

In the *CLEAR/WRITE* display mode, all available detectors can be selected. In the default mode, the autopeak detector (setting *AUTO*) is selected.

Each time the *CLEAR/WRITE* softkey is actuated, the analyzer clears the selected trace memory and restarts the measurement.

Remote: DISP:WIND:TRAC:MODE WRIT

The *MAX HOLD* softkey activates the max peak detector.

The analyzer saves the sweep result in the trace memory only if the new value is greater than the previous one.

The signal spectrum is filled upon each sweep until all signal components are detected in a kind of envelope.

Pressing the *MAX HOLD* softkey again clears the trace memory and restarts the max hold mode.

Remote: `DISP:WIND:TRAC:MODE MAXH`

The *MIN HOLD* softkey activates the min peak detector.

The analyzer saves the sweep result in the trace memory only if the new value is greater than the previous one.

The signal spectrum is filled up upon each sweep until all signal components are detected in a kind of envelope.

Pressing the *MIN HOLD* softkey again clears the trace memory and restarts the max hold mode.

Remote: `DISP:WIND:TRAC:MODE MINH`

AVERAGE

The *AVERAGE* softkey activates the trace averaging function. The average is formed over several sweeps. Averaging can be performed with any of the detectors available. If the detector is automatically selected by the analyzer, the sample detector is used.

Averaging is restarted every time the *AVERAGE* softkey is pressed. The trace memory is always cleared.

Remote: `DISP:WIND:TRAC:MODE AVER`

VIEW

The *VIEW* softkey freezes the current contents of the trace memory and displays them.

If a trace is frozen by *VIEW*, the instrument settings can be changed without the displayed trace being modified (exception: level display range and reference level, see below). The fact that the trace and the current instrument setting no longer agree is indicated by an enhancement label "*" at the right edge of the grid.

If in the *VIEW* display mode the level display range (*RANGE*) or the reference level (*REF LEVEL*) is changed, the R&S Analyzer automatically adapts the measured data to the changed display range. This allows an amplitude zoom to be carried out after the measurement in order to show details of the trace.

Remote `DISP:WIND:TRAC:MODE VIEW`

SWEEP COUNT

The *SWEEP COUNT* softkey activates the entry of the number of sweeps used for averaging. The allowed range of values is 0 to 30000 and the following should be observed:

Sweep Count = 0 means running averaging

Sweep Count = 1 means no averaging being carried out

Sweep Count > 1 means averaging over the selected number of sweeps; in the continuous sweep mode averaging is performed until the set number of sweeps is attained and is then continued as running averaging.

The default setting is running averaging (Sweep Count = 0). The number of sweeps used for averaging is the same for all active traces in the selected diagram.

Remote: SENS:SWE:COUN 64

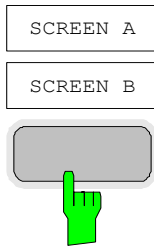

By using the hotkeys *SCREEN A* or *SCREEN B*, the upper (A) or lower (B) part of the display screen can be selected. The trace statistic functions described above are applied only to the measurement results, which are displayed in the selected screen. The display of special interest is the RESULT SUMMARY. It is shown in the lower part (SCREEN B). If the trace statistic functions are applied to the result summary, the affected results are marked if it is an average result, a max hold or a min hold result.

CLEAR/WRITE Displays the result value of the last sweep (<none>)

MAX HOLD: Displays the maximum result values of a number of sweeps (<MAX>)

MIN HOLD: Displays the minimum result value of a number of sweeps (<MIN>)

AVERAGE: displays the average result value of a number of sweeps (<AVG>)

The number of evaluated sweeps depends on the sweep count value. The figure below shows an example of the result summary display with applied sweep averaging. All averaged values are marked with "AVG". In particular, the resolution and accuracy of the trigger-to-frame value can be increased by using the trace average mode

Result Summary		SR 960 ksp/s	Chan Code 64
CF 1.2 GHz	Slot # 0	Mapping I	
GLOBAL RESULTS			
Total Power	AVG	-15.47 dBm	Carr Freq Err AVG 72.40 Hz
Chip Rate Err	AVG	-0.24 ppm	Trg to Frame AVG 266.675562 μs
IQ Offset	AVG	0.22 %	IQ Imbalance AVG 0.05 %
Composite EVM	AVG	2.78 %	PkCDE (15ksp/s) AVG -53.67 dB
Slot No		0	No of Active Chan 6
CHANNEL RESULTS			
Symbol Rate		960.00 ksp/s	Channel Mapping I
Channel Code		1	
No of Pilot Bits		0	
Chan Pwr Rel	AVG	-7.79 dB	Chan Pwr Abs AVG -23.26 dBm
Symbol EVM	AVG	2.34 % rms	Symbol EVM AVG 7.03 % Pk

SWP 8 of 20

Figure 7-36: Result summary with applied average mode

7.5.15 Display-Lines – Key *LINES*

The *LINES* key is disabled for all measurements in the code domain power. For all other measurements, the menu settings are equivalent to those of the corresponding measurement in the basic unit; the associated softkeys are described in the manual of the basic unit.

7.5.16 Settings of Measurement Screen – Key *DISP*

The menu of the *DISP* key contains softkeys for the configuration of the measurement screen. The menus and the softkey functions are described in the manual of the basic unit.

7.5.17 Storing and Loading of Unit Data – Key FILE

The *FILE* menu is identical to that of the basic unit. All softkeys are described in the manual of the basic unit.

All keys of the analyzer front panel that are not specifically mentioned are identical to those of the basic unit. The key functions and the softkeys are described in the manual of the basic unit.

8 Remote-Control Commands

The following chapter describes the remote-control commands for the application firmware. An alphabetical list at the end of this chapter provides an overview of the commands. The commands, which are also valid for the basic unit in the signal analyzer mode as well as the system settings, are described in the operating manual of the analyzer.

8.1 CALCulate – Subsystem

8.1.1 CALCulate:FEED – Subsystem

The CALCulate:FEED subsystem selects the evaluation method for the measured data. This corresponds to the result display selection in manual operation.

CALCulate<1|2>:FEED

This command selects the measured data that are to be displayed.

Parameter

<string>:

The string parameters have the following meaning:

- 'XPOWer:CDPower'
Result display of code domain power as bar graph absolute scaling (CALCulate<1>)
- 'XPOWer:CDPower:ABSsolute'
Result display of code domain power as bar graph absolute scaling (CALCulate<1>)
- 'XPOWer:CDPower:RATio'
Result display of code domain power ratio as bar graph relative scaling (CALCulate<1>)
- 'XPOWer:CDPower:OVERview'
Result display of code domain power (both I and Q component) as bar graph (CALCulate<1>)
- XPOWer:CDPower'
Result display of code domain error power as bar graph (CALCulate<1>)
- 'XTIME:CDPower:CHIP:EVM'
Result display of error vector magnitude (EVM) versus Chip
- 'XTIME:CDPower:CHIP:MAGNitude'
Result display of magnitude error versus chip
- 'XTIME:CDPower:CHIP:PHASe'
Result display of phase error versus chip
- 'XTIME:CDPower:COMP:CONStellation'
Result display of composite constellation (CALCulate2)
- XTIME:CDPower:ERRor:SUMMary'
Result display in tabular form (CALCulate2)

'XTIMe:CDPower:ERRor:CTABLE'
Result display of channel assignment table (CALCulate<1>)

'XTIM:CDP:ERR:PCD'
Result display of peak code domain error (CALCulate2)

'XTIM:CDP:FVSL'
Result display of frequency versus Slot (CALCulate2)

'XTIMe:CDPower:MACCuracy'
Result display of composite EVM (error vector magnitude referenced to the overall signal) (CALCulate2)

'XTIM:CDPower:PVSLOT'
Result display of power versus slot (CALCulate2)

'XTIM:CDPower:PVSLOT:ABSolute'
Result display of power versus slot [absolute scaling] (CALCulate2)

'XTIM:CDPower:PVSLOT:RAT'
Result display of power versus slot

'XTIM:CDPower:PVSY'
Result display of power versus symbol (CALCulate2)

'XTIM:CDPower:BSTR'
Result display of bit stream (CALCulate2)

'XTIM:CDPower:SYMBOL:CONStellation'
Result display of symbol constellation (CALCulate2)

'XTIM:CDPower:SYMBOL:EVM'
Result display of symbol error vector magnitude (CALCulate2)

'XTIM:CDPower:SYMBOL:EVM:PHASe'
Result display of the phase of EVM versus symbols (CALCulate2)

'XTIMe:CDPower:SYMBOL:EVM:MAGNitude'
Result display of the magnitude of EVM versus symbols (CALCulate2)

Example

```
CALC2:FEED `XTIM:CDP:MACC`
```

Characteristics

- * *RST value: 'XTIM:OFF'

SCPI: conforming



For code domain power (CDP) measurements, the display is always operated in the SPLIT SCREEN mode and the assignment of display mode to measurement window is fixed. Therefore, the numeric suffix that is required or permitted is given in brackets for each display mode.

8.1.2 CALCulate:LIMit – Subsystem

8.1.2.1 CALCulate:LIMit:ACPower Subsystem

The CALCulate:LIMit:ACPower subsystem defines limit checking for adjacent channel power measurements.

CALCulate<1|2>:LIMit1:ACPower:ACHannel:ABSolute

This command defines the absolute limit value for the lower/upper adjacent channel during adjacent-channel power measurement (Adjacent Channel Power) in the selected measurement window.

It should be noted that the absolute limit value has no effect on the limit check as soon as it is below the relative limit value defined with

CALCulate:LIMit:ACPower:ACHannel:RELative. This mechanism allows automatic checking of the absolute basic values of adjacent channel power as defined in mobile radio standards.

Parameter

200DBM...200DBM, -200...200DBM

The first value is the limit for the lower and the upper adjacent channel. The second limit value is ignored but must be indicated for reasons of compatibility with the FSE family.

Example

```
CALC:LIM:ACP:ACH:ABS -35DBM, -35DBM
```

'Sets the absolute limit value in for the power in the lower and upper adjacent channel to -35 dBm.

Characteristics

- * *RST value: 200DBM
- SCPI: device-specific

CALCulate<1|2>:LIMit1:ACPower:ACHannel:ABSolute:STATe

This command activates the limit check for the adjacent channel when adjacent-channel power measurement (Adjacent Channel Power) is performed. Before the command, the limit check for the channel/adjacent-channel measurement must be globally switched on using CALC:LIM:ACP ON.

The result can be queried with

CALCulate:LIMit:ACPower:ACHannel:RESult?. It should be noted that a complete measurement must be performed between switching on the limit check and the result query, since otherwise no valid results are available.

Parameter

ON | OFF

Example

```
CALC:LIM:ACP:ACH:REL:STAT ON
```

"Switches on the check of absolute limit values for the adjacent channels.

Characteristics

- * *RST value: OFF
- SCPI: device-specific

CALCulate<1|2>:LIMit1:ACPpower:ACHannel[:RELative]

This command defines the relative limit of the upper/lower adjacent channel for adjacent channel power measurements in the selected measurement window. The reference value for the relative limit value is the measured channel power. It should be noted that the relative limit value has no effect on the limit check as soon as it is below the absolute limit value defined with

`CALC:LIM:ACP:ACH:ABS`. This mechanism allows automatic checking of the absolute basic values of adjacent channel power as defined in mobile radio standards.

Parameter

0 to 100dB,
0 to 100dB

The first numeric value is the limit for the upper (lower) adjacent channel. The second value is ignored but must be indicated for reasons of compatibility with the FSE family.

Example

```
CALC:LIM:ACP:ACH 30DB, 30DB
```

'Sets the relative limit value in for the power in the lower and upper adjacent channel to 30 dB below the channel power

Characteristics

- *RST value: : 0 DB
- SCPI: device-specific

CALCulate<1|2>:LIMit1:ACPpower:ACHannel[:RELative]:STATE

This command activates the limit check for the relative limit value of the adjacent channel when adjacent channel power measurement is performed. Before the command, the limit check must be activated using

```
CALCulate:LIMit:ACPpower:STATE ON.
```

The result can be queried with

`CALCulate:LIMit:ACPpower:ACHannel:RESult?`. It should be noted that a complete measurement must be performed between switching on the limit check and the result query, since otherwise no valid results are available.

Parameter

ON | OFF

Example

```
CALC:LIM:ACP:ACH:REL:STAT ON
```

'Switches on the check of the relative limit values for adjacent channels.

Characteristics

*RST value: OFF

SCPI: device-specific

CALCulate<1|2>:LIMit1:ACPpower:ACHannel:RESult?

This command queries the result of the limit check for the upper/lower adjacent channel in the selected measurement window when adjacent channel power measurement is performed.

If the power measurement of the adjacent channel is switched off, the command produces a query error.

Parameter

The result is returned in the form <result>, <result> where <result> = PASSED | FAILED, and where the first returned value denotes the lower, the second denotes the upper adjacent channel.

Example

```
CALC:LIM:ACP:ACH:RES?
```

'Queries the limit check result in the adjacent channels Sets the relative limit value for the power in the lower and upper adjacent channel to 30 dB below the channel power.

Characteristics

*RST value: -

SCPI: device-specific

This command is an "event" which is why it is not assigned an *RST value and has no query.

CALCulate<1|2>:LIMit1:ACPpower:ALternate<1...11>:ABSolute

This command defines the absolute limit value for the selected alternate adjacent channel power measurement (Adjacent Channel Power) in the selected measurement window.

The numeric suffix after ALternate denotes the first or the second alternate channel.

It should be noted that the absolute limit value for the limit check has no effect as soon as it is below the relative limit value defined with

CALCulate:LIMit:ACPpower:ALternate:RELative. This mechanism allows automatic checking of the absolute basic values defined in mobile radio standards for the power in adjacent channels.

Parameter

200DBM...200DBM, -200...200DBM

The first value is the limit for the lower and the upper alternate adjacent channel.

The second limit value is ignored but must be indicated for reasons of

compatibility with the FSE family.

Example

```
CALC:LIM:ACP:ALT2:ABS -35DBM, -35DBM
```

'Sets the absolute limit value for the power in the lower and upper second alternate adjacent channel to -35 dBm.

Characteristics

*RST value: 200DBM

SCPI: device-specific

CALCulate<1|2>:LIMit1:ACPpower:ALTErnate<1...11>:ABSolute:STATe

This command activates the limit check for the selected alternate adjacent channel in the selected measurement window for adjacent channel power measurement (Adjacent Channel Power).

Before the command, the limit check must be globally switched on for the channel/adjacent channel power with the command `CALC:LIM:ACP:STAT ON`. The numeric suffix after `ALTErnate` denotes the alternate channel.

The result can be queried with

```
CALCulate:LIMit:ACPpower:ALTErnate:RESult?. It should be noted that a complete measurement must be performed between switching on the limit check and the result query, since otherwise no valid results are available.
```

Parameter

ON | OFF

Example

```
CALC:LIM:ACP:ALT:ABS:STAT ON
```

'Switches on the check of absolute limit values for the first alternate adjacent channels.

Characteristics

*RST value: OFF

SCPI: device-specific

CALCulate<1|2>:LIMit1:ACPpower:ALTErnate<1...11>[:RELative]

This command defines the limit for the selected alternate adjacent channel in the selected measurement window for adjacent channel power measurements. The reference value for the relative limit value is the measured channel power.

The numeric suffix after `ALTErnate<1...11>` denotes the first or the second alternate channels. It should be noted that the relative limit value has no effect on the limit check as soon as it is below the absolute limit defined with

```
CALCulate:LIMit:ACPpower:ALTErnate:ABSolute. This mechanism allows automatic checking of the absolute basic values of adjacent channel power as defined in mobile radio standards.
```

Parameter

0...100DB, 0...100DB

The first value is the limit for the lower and the upper alternate adjacent channel. The second limit value is ignored but must be indicated for reasons of compatibility with the FSE family.

Example

```
CALC:LIM:ACP:ALT2 30DB, 30DB
```

'Sets the relative limit value for the power in the lower 'and upper second alternate adjacent channel to 30 dB below the channel power.

Characteristics

*RST value: 0DB

SCPI: device-specific

CALCulate<1|2>:LIMit1:ACPpower:ALTErnate<1...11>[:RELative]:STATe

Dieser Befehl aktiviert bei Nachbarkanal-Leistungsmessung (Adjacent Channel Power) die Grenzwertprüfung für den ersten/zweiten Alternate-Nachbarkanal im ausgewählten Messfenster.

Zuvor muss mit dem Befehl die `CALC:LIM:ACP:STAT ON` die Grenzwertprüfung für die Kanal-/Nachbarkanalleistung insgesamt eingeschaltet werden.

Das numerische Suffix bei `ALTErnate<1...11>` kennzeichnet den "Alternate" Kanal.

Parameter

ON | OFF

Example

```
CALC:LIM:ACP:ALT:REL:STAT ON
```

'Switches on the check of the relative limit values for the first alternate adjacent channels

Characteristics

*RST value: OFF

SCPI: device-specific

CALCulate<1|2>:LIMit1:ACPpower:ALTErnate<1...11>:RESult?

This command queries the result of the limit check for the selected alternate adjacent channel in the selected measurement window for adjacent channel power measurements.

The numeric suffix after `ALTErnate` denotes the alternate channel.

If the power measurement of the adjacent channel is switched off, the command produces a query error .

Parameter

The result is returned in the form `<result>, <result>` where `<result> = PASSED |`

FAILED and where the first (second) returned value denotes the lower (upper) alternate adjacent channel.

Example

```
CALC:LIM:ACP:ALT:RES
```

'Queries the limit check result in the second alternate adjacent channels.

Characteristics

*RST value: -

SCPI: device-specific

This command is an "event" which is why it is not assigned an *RST value and has no query.

CALCulate<1|2>:LIMit1:ACPpower[:STATe]

This command switches on and off the limit check for adjacent channel power measurements in the selected measurement window. The commands

```
CALCulate:LIMit:ACPpower:ACHannel:STATe or
```

```
CALCulate:LIMit:ACPpower:ALternate:STATe
```

must be used in addition to specify whether the limit check is to be performed for the upper/lower adjacent channel or for the alternate adjacent channels.

Parameter

ON | OFF

Example

```
CALC:LIM:ACP ON
```

Characteristics

*RST value: OFF

SCPI: device-specific

8.1.2.2 CALCulate:LIMit:ESPECtrum Subsystem

CALCulate:LIMit:ESPECtrum:CHECK:X?

With this commands the frequency value of the worst fail of a SEM measurement can be queried.

Unit

[Hz]

Example

```
CALC:LIM:ESP:CHEC:X?"
```

Characteristics

*RST value: -

SCPI: device-specific

CALCulate:LIMit:ESPECtrum:CHECK:Y?

With this command the power value of the worst fail of a SEM measurement can be queried.

Unit

[dBm]

Example

```
CALC:LIM:ESP:CHEC:Y?"
```

Characteristics

*RST value: -

SCPI: device-specific

CALCulate:LIMit:ESPECtrum:MODE

This command activates or deactivates automatic selection of the limit line in the spectrum emission mask measurement.

Parameter

AUTO The limit line is set as a function of the measured channel power.

USER Query only; user-defined limit lines are active

(refer to description of limit lines in manual for basic unit).

Example

```
CALC:LIM:ESP:MODE AUTO
```

Characteristics

*RST value: AUTO

SCPI: device-specific

CALCulate<1|2>:LIMit<1...8>:ESPectrum:TRANsition

The command specifies the offset frequency at which the resolution bandwidth is changed between 30 kHz and 1 MHz. The default value is 3.5 MHz.

Parameter

<numeric value>

Example

```
CALC2:LIM:ESP:TRAN 3 MHz
```

Characteristics

*RST value: 3.5 MHz

SCPI: device-specific

8.1.3 CALCulate:MARKer – Subsystem**CALCulate<1|2>:MARKer<1...4>:FUNCtion:POWER:RESult:PHZ**

This command switches the query response of the power measurement results in the indicated measurement window between output of absolute values (OFF) and output referred to the measurement bandwidth (ON). The measurement results are output with `CALC:MARK:FUNC:POW:RES?`

Parameter

ON: Results output referred to measurement bandwidth

OFF: Results output in absolute values

Example

```
CALC:MARK:FUNC:POW:RES:PHZ ON
```

Characteristics

*RST value: -

SCPI: device-specific

CALCulate<1|2>:MARKer<1>:FUNCtion:WCDPower:MS:RESult?

This command queries the measured and calculated results of the 3GPP FDD code domain power measurement.

Parameter

PTOTAL	total power
FERRor	frequency error in Hz
TFRame	trigger to frame
MACCuracy	composite EVM
PCDerror	peak code domain error
EVMRms	error vector magnitude RMS
EVMPeak	error vector magnitude peak
CERRor	chip rate error

SRATe	symbol rate
CHANnel	channel number
CDPabsolute	channel power absolut
CDPRelative	channel power relativ
IQOFFset	I/Q offset
IQIMbalance	I/Q imbalance
CMApPping	Channel component
PSYMBOL	Number of pilot bits
RHO	Quality parameter RHO for every slot
TOFFset	Offset between the start of the first slot in the channel and the start of the analyzed 3GPP FDD frame.
MPIC	average power of the inactive codes for the selected slot
MTYPE	modulation type of the selected channel
ACHannels	number of active channels
RCDerror	residual code domain error for selected channel
ARCDerror	average of residual code domain errors of channels that use 4PAM modulation

Example

```
CALC:MARK:FUNC:WCDP:MS:RES? PTOT
```

Characteristics

*RST value: -

SCPI: device-specific

8.1.4 CALCulate:PEAKsearch – Subsystem**CALCulate<1|2>:PEAKsearch:AUTO**

This command calculates a peak list of the spectrum emission mask measurement at each sweep. One peak value is determined for each range of the limit line.

With this command the list evaluation which is by default for backwards compatibility reasons off can be turned on.

Parameter

ON: Enables automatic peak search

OFF: Disables automatic peak search

Example

```
CALC1:PEAK:AUTO ON
```

Characteristics OFF

*RST value: OFF

SCPI: device-specific

8.1.5 CALCulate:STATistics - Subsystem

The CALCulate:STATistics subsystem controls the statistical measurement functions in the instrument. The measurement window cannot be selected with these functions. The numeric suffix in CALCulate is therefore ignored.

CALCulate:STATistics:MS:CCDF[:STATe]

This command switches on or off the measurement of the complementary cumulative distribution function (CCDF).

Parameter

ON | OFF

Example

```
CALC:STAT:MS:CCDF ON
```

Characteristics

*RST value: OFF

SCPI: device-specific

CALCulate:STATistics:NSAMples

This command sets the number of measurement points to be acquired for the statistical measurement functions.

Parameter

100 ... 32768

Example

```
CALC:STAT:NSAM 5000
```

Characteristics

*RST value: 10000

SCPI: device-specific

CALCulate:STATistics:PRESet

This command resets the scaling of the X and Y axes in a statistical measurement. The following values are set:

X axis ref level: -20 dBm

X axis range APD: 100 dB

X axis range CCDF: 20 dB

Y axis upper limit: 1.0

Y axis lower limit: 1E-6

Example

```
CALC:STAT:PRESET
```

' Resets the scaling for statistical functions.

Characteristics

*RST value: -

SCPI: device-specific

This command is an "event" which is why it is not assigned an *RST value and has no query.

CALCulate:STATistics:SCALe:Y:LOWer

This command defines the lower limit for the Y-axis of the diagram in statistical measurements. Since probabilities are specified on the Y-axis, the entered numerical values are dimensionless.

Parameter

1E-6 ...0.1

Example

```
CALC:STAT:SCAL:Y:LOW 0.001
```

Characteristics

*RST value: 1E-6

SCPI: device-specific

CALCulate:STATistics:SCALe:Y:UPPer

This command defines the upper limit for the Y-axis of the diagram in statistical measurements. Since probabilities are specified on the Y-axis, the entered numerical values are dimensionless.

Parameter

1E-5 ...1.0

Example

```
CALC:STAT:SCAL:Y:UPP 0.01
```

Characteristics

*RST value: 1.0

SCPI: device-specific

8.2 CONFigure:WCDPower Subsystem

This subsystem comprises the commands for configuring the code domain power measurements. Only the numeric suffix 1 is permissible in CONFigure

CONFigure:WCDPower:MS:CTABLE:CATalog?

This command reads out the names of all channel tables stored on the hard disk.

Syntax of output format:

<Sum of file lengths of all subsequent files>,<free memory on hard disk>,
<1st file name>,,<1st file length>,<2nd file name>,,<2nd file length>,.....,<nth file
name>,<nth file length>

Example

```
CONF:WCDP:MS:CTAB:CAT?
```

Characteristics

*RST value: -

SCPI: device-specific

CONFigure:WCDPower:MS:CTABLE:COMMENT

This command defines a comment for the selected channel table

Prior to this command, the name of the channel table has to be defined with command CONF:WCDP:MS:CTAB:NAME and the values of the table have to be defined with command CONF:WCDP:MS:CTAB:DATA.

Parameter

<string>

Example

```
CONF:WCDP:MS:CTAB:COMM 'Comment for table 1'
```

Characteristics

*RST value: ""

SCPI: device-specific

CONFigure:WCDPower:MS:CTABLE:COPY

This command copies one channel table onto another one. The channel table to be copied is selected with command CONF:WCDP:MS:CTAB:NAME.

Parameter

<file_name> := name of the new channel table

Example

```
CONF:WCDP:MS:CTAB:COPY 'CTAB_2'
```

Characteristics

*RST value: -

SCPI: device-specific

The name of the channel table may contain a maximum of 8 characters. This command is an "event" which is why it is not assigned an *RST value and has no query.

CONFigure:WCDPower:MS:CTABLE:DATA

This command defines the values of the selected channel table. Each line of the table consists of 6 values:

<pilot length>,<code class>,<number of active channels>,<CDP rel. 1 [dB]>,<CDP rel. 2 [dB]>,<CDP rel. 3 [dB]>,<CDP rel. 4 [dB]>,<CDP rel. 5 [dB]>,<CDP rel. 6 [dB]>

Pilot length: pilot length of channel DPCCH

Code class: code class of channel 1. I-mapped

Number of active channels: 1 to 7

CDP rel. 1: measured value of channel 1, only when queried

CDP rel. 2: measured value of channel 2, only when queried

CDP rel. 3: measured value of channel 3, only when queried

CDP rel. 4: measured value of channel 4, only when queried

CDP rel. 5: measured value of channel 5, only when queried

CDP rel. 6: measured value of channel 6, only when queried

The Channel DPCCH may only be defined once. If channel DPCCH is missing in the command, it is automatically added at the end of the table.

Prior to this command, the name of the channel table has to be defined with command `CONF:WCDP:MS:CTAB:NAME`.

Parameter

<numeric_value>,<numeric_value>

Example

```
CONF:WCDP:MS:CTAB:DATA 8,4,1
```

Characteristics

*RST value: -

SCPI: device-specific

CONFigure:WCDPower:MS:CTABLE:DATA:HSDPcch

This command activates [ON] or deactivates [OFF] the HS-DPCCH entry in a predefined channel table.

Parameter

ON|OFF

Example

```
CONF:WCDP:MS:CTAB:DATA:HSDP ON
```

Characteristics

*RST value: ON

SCPI: device-specific

CONFigure:WCDPower:MS:CTABLE:DELeTe

This command deletes the selected channel table. The channel table to be deleted is selected with command `CONF:WCDP:MS:CTAB:NAME`.

Example

```
CONF:WCDP:MS:CTAB:DEL
```

Characteristics

*RST value: -

SCPI: device-specific

This command is an "event" which is why it is not assigned an *RST value and has no query.

CONFigure:WCDPower:MS:CTABLE:EDATa

This command defines the values of the selected channel table.

Code class: code class of channel 1.

Number of active channels: 0 to 4

ECDP rel. 1: measured value of channel 1, only when queried

ECDP rel. 2: measured value of channel 2, only when queried

ECDP rel. 3: measured value of channel 3, only when queried

ECDP rel. 4: measured value of channel 4, only when queried.

Parameter

code class>,<number of active channels>,
<CDP rel. 1 [dB]>,<CDP rel. 2 [dB]>,<CDP rel. 3 [dB]>,
<CDP rel. 4 [dB]>

Example

```
CONF:WCDP:MS:CTAB:EDAT
```

Characteristics

*RST value: -

SCPI: device-specific

CONFigure:WCDPower:MS:CTABLE:EDATa:EDPCch

This command activates [ON] or deactivates [OFF] the E-DPCCH entry in a predefined channel table.

Parameter

ON|OFF

Example

```
CONF:WCDP:MS:CTAB:EDAT:EDPC ON
```

Characteristics

*RST value: OFF

SCPI: device-specific

CONFigure:WCDPower:MS:CTABle:NAME

This command selects an existing channel table or creates the name of a new channel table.

Parameter

<file_name>

Example

```
CONF:WCDP:MS:CTAB:NAME 'NEW_TAB'
```

Characteristics

*RST value: ""

SCPI: device-specific

CONFigure<1>:WCDPower:MS:CTABle:SElect

This command selects a predefined channel table file. Before using this command, the RECENT channel table must be switched on first with the command `CONF:WCDP:CTAB:STATe ON`.

Parameter

<string>

Example

```
CONF:WCDP:MS:CTAB1 ON
CONF:WCDP:MS:CTAB:SEL 'CTAB_1'
```

Characteristics

*RST value: RECENT

SCPI: device-specific

CONFigure<1>:WCDPower:MS:CTABle[:STATe]

This command switches the channel table on or off. On switching on, the measured channel table is stored under the name RECENT and switched on. After the RECENT channel table is switched on, another channel table can be selected with the command `CONF:WCDP:MS:CTABle:SEL`.

Note:

The RECENT channel table must always be switched on first with the command `CONF:WCDP:MS:CTAB:STAT` and then the required channel table can be selected with the command `CONF:WCDP:CTAB:SEL`.

Parameter

ON | OFF

Example

```
CONF:WCDP:MS:CTAB ON
```

Characteristics

*RST value: OFF

SCPI: device-specific

CONFigure<1>:WCDPower:MS:MEASurement

This command selects the 3GPP FDD user equipment tests. The settings of the predefined measurements are described for the associated softkey in chapter 6.

Parameter

POWer

Channel power measurement (standard 3GPP FDD Forward) with predefined settings

ACLR

Adjacent channel power measurement (standard 3GPP 3GPP FDD Forward) with predefined settings

ESpectrum

Measurement of spectrum emission mask

OBANdwith | OBWidth

Measurement of occupied power bandwidth

WCDPower

Code domain power measurement. This selection has the same effect as command `INST:SEL WCDP`

CCDF

Measurement of Complementary Cumulative Distribution Function

Example

```
CONF:WCDP:MS:MEAS POW
```

Characteristics

*RST value: POWer

SCPI: device-specific

8.3 DISPLAY - Subsystem

The DISPLAY subsystem controls the selection and presentation of textual and graphic information as well as of measurement data on the display. The measurement windows are selected by WINDOW1 (screen A) or WINDOW2 (screen B).

DISPLAY[:WINDOW<1|2>]:SIZE

This command switches the diagram to full screen size.

Parameter

LARGE: full screen size

SMALL: small screen size of the ACLR diagram

Example

```
DISP:WIND1:SIZE LARG
```

'Switches the diagram to full screen size

Characteristics

*RST value: SMALL

SCPI: device-specific

Query of results

```
DISP:WIN1:SIZE?
```

Result:

```
<LARGE | SMALL>
```

DISPLAY[:WINDOW<1|2>]:TRACE<1...3>:MODE

This command freezes the current contents of the trace memory and displays them. If a trace is frozen by VIEW, the instrument settings can be changed without the displayed trace being modified (exception: level display range and reference level, see below). The fact that the trace and the current instrument setting no longer agree is indicated by an enhancement label "*" at the right edge of the grid. If in the VIEW display mode the level display range (RANGE) or the reference level (REF LEVEL) is changed, the R&S Analyzer automatically adapts the measured data to the changed display range. This allows an amplitude zoom to be carried out after the measurement in order to show details of the trace .

Parameter

VIEW

Example

```
DISP:WIND:TRAC:MODE VIEW
```

Characteristics

*RST value: WRITE for TRACE1, STATE OFF for TRACE2/3

SCPI: device-specific

8.4 INSTRument Subsystem

INSTRument[:SElect]

This command switches between the operating modes by means of text parameters. Selection MWCDpower presets the instrument as described in Chapter 3.1 “Basic Settings in Code Domain Measurement Mode”

Parameter

SANalyzer | RECeiver | MSGM | MWCDpower

Example

```
INST:SEL MWCD
```

Characteristics

*RST value: SANalyzer

SCPI: conforming

8.5 SENSE - Subsystem

8.5.1 SENSE:CDPower Subsystem

This subsystem controls the parameters for the code domain mode. The numeric suffix in SENSE<1|2> is not significant in this subsystem.

[SENSE<1|2>:]CDPower:BASE

This command chooses the base of the CDP analysis: At SLOT one slot of the signal is analyzed only; at FRAME the complete 3GPP frame will be analyzed.

Parameter

SLOT | FRAME

Example

```
SENS:CDP:BASE SLOT
```

Characteristics

*RST value: SLOT

SCPI: device-specific

[SENSE:]CDPower:CODE

This command sets the code number. The code number refers to code class 8 (spreading factor 256).

Parameter

0 ... 255

Example

```
SENS:CDP:CODE 128
```

Characteristics

*RST value: 0

SCPI: device-specific

[SENSe:]CDPower:ETCHips

This command selects length of the measurement interval for calculation of error vector magnitude (EVM). In accordance with 3GPP specification Release 5, the EVM measurement interval is one slot (4096 chips) minus 25 μ s at each end of the burst (3904 chips) if power changes are expected. If no power changes are expected, the evaluation length is one slot (4096 chips).

Parameter

ON: Changes of power are expected. Therefore an EVM measurement interval of one slot minus 25 μ s (3904 chips) is considered.

OFF: Changes of power are not expected. Therefore an EVM measurement interval of one slot (4096 chips) is considered

Example

```
SENS:CDP:ETCH ON
```

Characteristics

*RST value: OFF

SCPI: device-specific

[SENSe:]CDPower:FILTer[:STATE]

This command selects if a root raised cosine (RRC) receiver filter is used or not. This feature is useful if the RRC filter is implemented in the device under test (DUT).

Parameter

ON: If an unfiltered WCDMA signal is received (normal case), the RRC filter should be used to get a correct signal demodulation.

OFF: If a filtered WCDMA signal is received, the RRC filter should not be used to get a correct signal demodulation. This is the case if the DUT filters the signal .

Example

```
SENS:CDP:FILT:STAT OFF
```

Characteristics

*RST value: ON

SCPI: device-specific

[SENSe:]CDPower:FRAMe[:VALue]

This command defines the frame to be analyzed within the captured data.

Parameter

<numeric value> [0 ... CAPTURE_LENGTH - 1]

Example

```
SENS:CDP:FRAM:VAL 1
```

Characteristics

*RST value: 1

SCPI: device-specific

[SENSe<1|2>:]CDPower:HSDPamode

This command selects if the HS-DPCCH channel is searched or not.

Parameter

ON: The HSUPA/HSDPA channel can be detected.

OFF: The HSUPA/HSDPA channel cannot be detected.

Example

```
SENS:CDP:HSDP OFF
```

Characteristics

*RST value: ON

SCPI: device-specific

[SENSe:]CDPower:HSLot

This command switches the R&S FS-K73 between the analysis of one half and one full slot.

Parameter

ON | OFF

Example

```
SENS:CDP:HSL ON
```

Characteristics

*RST value: OFF

SCPI: device-specific

[SENSe:]CDPower:ICTReshold

This command sets the threshold value from which a channel is treated as active. The level entered refers to the total signal power.

Parameter

100 dB ... 10 dB

Example

```
SENS:CDP:ICTR -10DB
```

Characteristics

*RST value: -60dB

SCPI: device-specific

[SENSe:]CDPower:IQLength

This command defines the number of frames which are captured for every sweep.

Parameter

Range: R&S FSU (*free run*): <numeric value> [1 ... 2]
 R&S FSU (*ext. Trig*): <numeric value> [1 ... 3]
 R&S FSQ: <numeric value> [1 ... 100]

Example

```
SENS:CDP:IQL 1
```

Characteristics

*RST value: 1

SCPI: device-specific

[SENSe:]CDPower:LCODE:TYPE

This command switches between long and short scrambling code.

Parameter

LONG | SHORT

Example

```
SENS:CDP:LCOD:TYPE SHOR
```

Characteristics

*RST value: LONG

SCPI: device-specific

[SENSe:]CDPower:LCODE[:VALue]

This command defines the scrambling code in hexadecimal format.

Parameter

#H0 ... #H1fff

Example

```
SENS:CDP:LCOD #H2
```

Characteristics

*RST value: -

SCPI: device-specific

[SENSe:]CDPower:MAPPING

This command switches between I and Q component of the signal.

Parameter

I | Q

Example

```
SENS:CDP:MAPP I
```

Characteristics

*RST value: I

SCPI: device-specific

[SENSe:]CDPower:NORMALize

This command switches elimination of IQ offset on or off..

Parameter

ON | OFF

Example

```
SENS:CDP:NORM OFF
```

Characteristics

*RST value: OFF

SCPI: device-specific

[SENSe<1|2>:]CDPower:OVERview

This command switches to an overview display of a code domain measurement (CDPrel. / CDPabs. / CDEP). If it is enabled ("ON"), the I branch of the code power is displayed in screen A and the Q branch in screen B. Both results can be read via IEC by using TRACE:DATA? TRACE1 and TRACE:DATA? TRACE2 respectively. If it is disabled ("OFF"), screen A displays the I branch and screen B provides the result summary display.

Parameter

ON | OFF

Example

```
SENS:CDP:OVER OFF
```

Characteristics

*RST value: OFF

SCPI: device-specific

[SENSe:]CDPower:SBANd

This command is for interchanging the left and the right sideband.

Parameter

NORMal | INVers

Example

```
SENS:CDP:SBAN INV
```

Characteristics

*RST value: NORM

SCPI: device-specific

SENSe:]CDPower:SFACTOR

This command defines the spreading factor. The spreading factor is only significant for display mode PEAK CODE DOMAIN ERROR.

Parameter

[4 | 8 | 16 | 32 | 64 | 128 | 256

Example

```
SENS:CDP:SFAC 256
```

Characteristics

*RST value: 256

SCPI: device-specific

[SENSe:]CDPower:SLOT

This command sets the slot number.

Parameter

0 ...14

Example

SENS:CDP:SLOT 3

Characteristics

*RST value: 0

SCPI: device-specific

8.5.2 SENSE:POWER - Subsystem

This subsystem controls the parameters for the spectral power measurements. The numeric suffix in `SENSe<1|2>` is not significant in this subsystem).



Die Funktionen dieses Subsystems sind bei GSM Messungen nicht verfügbar.

SENSe<1|2>:POWER:ACHannel:ACPairs

This command sets the number of adjacent channels (upper and lower channel in pairs). The number 0 stands for pure channel power measurement.

Parameter

<value>

Example

SENS:POW:ACH:ACP 3

Characteristics

Range: 0 | 1 | 2 | 3

Unit: []

*RST value: 2

SCPI: device-specific

Query of results

SENS:POW:ACH:ACP?

Result

<0 | 1 | 2 | 3>

[SENSe<1|2>:]POWer:ACHannel:BANDwidth|BWIDth[:CHANnel]

This command sets the channel bandwidth of the radio communication system. The bandwidths of adjacent channels are not influenced by this modification.

Parameter

<value>

Example

```
SENS:POW:ACH:BWID 3.84MHz
```

Characteristics

Range: 100Hz ... 1GHz

Unit: [Hz]

*RST value: 3.84 MHz

SCPI: device-specific

Query of results

```
SENS:POW:ACH:BAND:CHAN?
```

Result

<100Hz ... 1GHz>

[SENSe<1|2>:]POWer:ACHannel:BANDwidth|BWIDth:ACHannel

This command defines the channel bandwidth of the adjacent channel of the radio transmission system. If the bandwidth of the adjacent channel is changed, the bandwidths of all alternate adjacent channels are automatically set to the same value.

Parameter

<value>

Example

```
SENS:POW:ACH:BWID:ACH 3.84MHz
```

Characteristics

Range: 100Hz ... 1GHz

Unit: [Hz]

*RST value: 3.84 MHz

SCPI: device-specific

Query of results

```
SENS:POW:ACH:BAND:CHAN?
```

Result

<100Hz ... 1GHz>

[SENSe<1|2>:]POWer:ACHannel:BAWIDth|BWIDth:ALTernate<1...11>

This command defines the channel bandwidth of the first/second alternate adjacent channel of the radio transmission system. If the channel bandwidth of alternate adjacent channel 1 is changed, the bandwidth of alternate adjacent channel 2 is automatically set to the same value.

Parameter

<value>

Example

```
SENS:POW:ACH:BWID:ALT 3.84MHz
```

Characteristics

Range: 100Hz ... 1GHz

Unit: [Hz]

*RST value: 3.84 MHz

SCPI: device-specific

Query of results

```
SENS:POW:ACH:BAWID:ALT<1...11>?
```

Result

<100Hz ... 1GHz>

SENSe<1|2>:]POWer:ACHannel:MODE

This command toggles between absolute and relative adjacent channel measurement. For the relative measurement the reference value is set to the currently measured channel power by command `SENS:POW:ACH:REF:AUTO ONCE`.

Parameter

ABSolut absolute adjacent channel measurement
RELative relative adjacent channel measurement

Example

```
SENS:POW:ACH:MODE REL
```

Characteristics

*RST value: ABSolute

SCPI: device-specific

Query of results

```
SENS:POW:ACH:MODE?
```

Result

< ABS | REL >

[SENSe<1|2>:]POWer:ACHannel:PRESet

This command adjusts the frequency span, the measurement bandwidths and the detector as required for the number of channels, the channel bandwidths and the channel spacings selected in the active power measurement. If necessary, adjacent-channel power measurement is switched on prior to the adjustment. To obtain valid results, a complete sweep with synchronization to the end of the sweep must be performed after the adjustment. Synchronization is possible only in the single-sweep mode.

Parameter

MCACpower

Example

```
SENS:POW:ACH:PRESet MCAC
```

Characteristics

*RST value: -

SCPI: device-specific

[SENSe<1|2>:]POWer:ACHannel:PRESet:RLEVel

This command adapts the reference level to the measured channel power. This ensures, that the signal path of the instrument is not overloaded. Since the measurement bandwidth is significantly smaller than the signal bandwidth in channel power measurements, the signal path can be overloaded although the trace is still significantly below the reference level. If the measured channel power equals the reference level, the signal path is not overloaded.

Example

```
SENS:POW:ACH:PRESet:RLEV
```

Characteristics

*RST value: -

SCPI: device-specific

[SENSe<1|2>:]POWer:ACHannel:REFerence:TXCHannel:AUTO

This command activates the automatic selection of a transmission channel to be used as a reference channel in relative adjacent-channel power measurements. The transmission channel with the highest power, the transmission channel with the lowest power, or the transmission channel nearest to the adjacent channels can be defined as a reference channel. The command is available only for multicarrier channel and adjacent-channel power measurements.

Parameter

MINimum	Transmission channel with the lowest power
MAXimum	Transmission channel with the highest power
LHIGhest	Lowermost transmission channel for the lower adjacent channels,

uppermost transmission channel for the upper adjacent channels

Example

```
SENS:POW:ACH:REF:TXCH:AUTO MAX
```

Characteristics

Unit []

*RST value: -

SCPI: device-specific

Query of results

```
SENS:POW:ACH:MODE?
```

Result

```
< ABS | REL >
```

[SENSe<1|2>:]POWER:ACHannel:REFerence:TXCHannel:MANual

This command selects a transmission channel to be used as a reference channel in relative adjacent-channel power measurements. The command is available only for multi carrier channel and adjacent-channel power measurements.

Parameter

<value>

Example

```
SENS:POW:ACH:REF:TXCH:MAN 3
```

Characteristics

Range: <1 ... number of TX channels >

Unit []

*RST value: 1

SCPI: device-specific

[SENSe<1|2>:]POWER:ACHannel:SPACing:CHANnel

This command defines the channel spacing of the adjacent channel to the TX channel. At the same time, the spacing of alternate adjacent channels 1 and 2 is set to the double or triple of the entered value.

Parameter

100 Hz ... 1000 MHz

Example

```
SENS:POW:ACH:SPAC:CHAN 5MHz
```

Characteristics

*RST value: 5 MHz kHz

SCPI: device-specific

[SENSe<1|2>:]POWER:ACHannel:SPACing[:ACHannel]

This command defines the channel spacing for the carrier signals. At the same time the spacing of carriers with higher channel number are set to the same value. If the spacing is equal between all carriers it is sufficient to set the spacing between carrier 1 and 2 with the command:

```
SENS:POW:ACP:SPAC:CHAN1
```

or

```
SENS:POW:ACP:SPAC:CHAN.
```

If the spacing are set in ascending order individual spacing of the carriers can be set.

Parameter

<value>

Example

```
POW:ACH:SPAC:ACH 5MHz
```

'setzt den Kanalabstand von Trägersignal zum Nachbarkanal auf 5 MHz, zum Alternate-Nachbarkanal 1 auf 10 MHz und zum Alternate-Nachbarkanal 2 auf 15 MHz

Characteristics

Range: 100Hz ... 1GHz

Unit [Hz]

*RST value: 5 MHz

SCPI: device-specific

Query of results

```
SENSe:POW:ACH:SPAC:CHAN?
```

Result

<100Hz ... 1GHz>

Hinweis:

If the ACP or MCACP measurement is started all settings according to the standard including the channel bandwidths and channel spacings are set and can be adjusted afterwards.

[SENSe<1|2>:]POWER:ACHannel:SPACing:ALTErnate<1...11>

This command defines the spacing between the first (ALTErnate1) or the second alternate adjacent channel (ALTErnate2) and the TX channel. If the spacing to the alternate adjacent channel ALTErnate1 is modified, the spacing to alternate adjacent

channel 2 is set to 1.5 times the entered value.

Parameter

<value>

Example

SENS:POW:ACH:SPAC:ALT1 10MHz

Characteristics

Range: 100Hz ... 1GHz

Unit [Hz]

*RST value: 10 MHz (ALT1)
15 MHz (ALT2)

SCPI: device-specific

[SENSe<1|2>:]POWER:HSPeed

This command switches on or off the high-speed adjacent channel leakage power measurement. The measurement itself is performed in the time domain on the center frequencies of the individual channels. The command automatically switches to the time domain and back. A weighting filters with root raised cosine characteristic and 0.22 roll off is used for band limitation.

Parameter

ON high-speed measurement with RRC filter in time domain
OFF measurement with gaussian filters in frequency domain

Example

POW:HSP ON

Characteristics

*RST value: OFF

SCPI: device-specific

[SENSe<1|2>:]POWER:NCORrection

This command switches on or off the correction of the instrument inherent noise for ACLR measurement. On activating this function, a reference measurement of the instrument inherent noise is performed. The measured noise power is then subtracted from the power in the examined channel. The instrument inherent noise is then re-determined after any change of the center frequency, resolution bandwidth, sweep time and level setting by repeating the reference measurement in the new instrument setting.

Parameter

ON inherent noise correction is switched on.
 OFF inherent noise correction is switched off

Example

```
SENS:POW:NCOR ON
'Schaltet die Korrektur des Eigenrauschens ein
```

Characteristics

*RST value: OFF
 SCPI: device-specific

Query of results

```
SENS:POWer:NCOR?
```

Result

```
<1|0>
```

8.6 STATus:QUEStionable:SYNC Register

This register contains information on the error situation in the code domain power analysis of the R&S FS-K73 option. It can be queried with the following commands:

STATus:QUEStionable:SYNC:CONDition?

This command reads the information on the error situation in the code domain power analysis of the R&S FS-K73 option.

Example

```
STAT:QUES:SYNC:COND?
```

Characteristics

*RST value: OFF
 SCPI: device-specific

Return value: see Table 8-1

STATus:QUEStionable:SYNC[:EVENTi] ?

This command reads the information on the error situation in the code domain power analysis of the FS-K73 option. The value can only be read once.

Example

```
STAT:QUES:SYNC:EVENT?
```

Characteristics

*RST value: OFF

SCPI: device-specific

Return value: see

Table 8-1: Definition of the error bits of the SYNC register

Bit No.	Definition
0	Not used in R&S FS-K73.
1	<p>R&S FS-K73 Frame Sync failed</p> <p>This bit is set when synchronization is not possible within the application.</p> <p>Possible reasons:</p> <ul style="list-style-type: none"> Incorrectly set frequency Incorrectly set level Incorrectly set scrambling code Incorrectly set values for Q-INVERT or SIDE BAND INVERT Invalid signal at input
2 to 4	Not used in the R&S FS-K73 application.
5	<p>R&S FS-K73 Incorrect Pilot Symbol</p> <p>This bit is set when one or more of the received pilot symbols are not equal to the specified pilot symbols of the 3GPP standard.</p> <p>Possible reasons:</p> <ul style="list-style-type: none"> Incorrectly sent pilot symbols in the received frame. Low signal to noise ratio (SNR) of the WCDMA signal. One or more code channels have a significantly lower power level compared with the total power. The incorrect pilots are detected in these channels because of low channel SNR. One or more channels are sent with high power ramping. In slots with low relative power to total power, the pilot symbols might be detected incorrectly (check the signal quality by using the symbol constellation display).
6 to 14	Not used in the R&S FS-K73 application.
15	This bit is always 0.

8.7 TRACe Subsystem

TRACe[:DATA]? TRACE1 | TRACE2 | ABITstream | CTABLE | CWCDp | TPVSlot | LIST | CEVM

This command transfers trace data from the controller to the instrument, the query reads trace data out of the instrument.

ABITstream can be set only if CALC2:FEED "XTIM:CDP:BSTReam" is selected (in the lower bitstream window). This command returns the bit streams of all 15 slots one after the other, the output format may be REAL, UINT or ASCII. The results of ABITstream are valid only if the analysis of one complete frame is selected. In slot mode the query always yields characters '9' to mark bits that are invalid.

The output format is equal to that of the ":TRACe1:DATA? TRACE2" command in case of an activated bitstream display. The only difference is the number of symbols which are evaluated. The ABITstream command evaluates all symbols of one frame. One value is transferred per bit (range 0,1,). Each symbol contains of one bit in case of BPSK modulation or two consecutive bits in case of 4PAM modulation. If the modulation type of the channel the bits are given for changes within the frame, always two consecutive bits are transferred for each symbol to provide an equal length of the string. At symbols with only one bit per symbol the second (unused) bit is marked with '9'. The number of symbols is not constant and may vary depending on the spreading factor of the selected channel. The bit stream may contain invalid bits(symbols without power). In this case the character '9' is transferred.

Unit: []

Range: {0, 1, 7, 9}

Bits per symbol: $N_{\text{BitPerSymb}} = 2$

Number of symbols: $N_{\text{Symb}} = 150 * 2^{(\text{8-Code Class})}$

Number of bits: $N_{\text{Bit}} = N_{\text{Symb}} * N_{\text{BitPerSymb}}$

Format: Bit₀₀, Bit₀₁, Bit₁₀, Bit₁₁, Bit₂₀, Bit₂₁, ..., ,
Bit_{NSymb 0}, Bit_{NSymb 1}

Explanation: 0 – Low state of a transmitted bit
1 – High state of a transmitted bit
7 – Suppressed symbol of a HS-DPCCH slot
9 – Bit of an inactive channel

CTABLE reads out the channel table: Seven values are transmitted for each channel, the sixth value (reserved for pilot length) being constantly 0:
< class>, <channel number>, <absolute level>, <relative level>, <l/Q component>, 0, <state>...

CWCDp can be set if CODE PWR ABSOLUTE / RELATIVE, CHANNEL TABLE is selected for trace 1. The pilot length, channel state, channel type, modulation type and a reserved value are transmitted in addition to the values transmitted for trace 1. For each channel, 11 values are transmitted

<code class>, <channel number>, <lQ component>, <absolute level>, <relative level>, <timing offset>, <pilot length>, <active flag>, <channel type>, <modulation type>, <reserved>...

No.	Parameter	Range	Unit	Explanation
1)	<code class>	{2 to 8}	[1]	Code class of the channel.
2)	<channel number>	{0 to 255}	[1]	Code number of the channel.
3)	<IQ component>	{0, 1}	[1]	IQ component of the channel.
		0 - Q component		Channel symbols (S_n) sent from quadrature component; only imaginary part of S_n is used. [Re $\{S_n\} = 0$ Im $\{S_n\} \neq 0$]
		1 - I component		Channel symbols (S_n) sent from In phase component; only real part of S_n is used. [Re $\{S_n\} \neq 0$ Im $\{S_n\} = 0$]
4)	<absolute level>	$\{-\infty$ to $\infty\}$	[dBm]	Absolute level of the code channel at the selected channel slot. (The channel slot can be marked by the SELECTED CPICH slot.)
5)	< relative level >	$\{-\infty$ to $\infty\}$	[dB]	Relative level of the code channel at the selected channel slot referenced to CPICH or total power. (The channel slot can be marked by the SELECTED CPICH slot.)
6)	<timing offset>	{0 to 2560}	[chips]	Timing offset of the HS-DPCCH to the frame start. The value is measured in chips. The step width is 256 chips. For all other data channels, the timing offset is zero.
7)	<pilot length>	{0 to 8}	[symbols]	Pilot length of the DPCCH.
8)	<active flag>	{0,1}	[1]	Flag to indicate whether a channel is active 0 - channel not active 1 - channel active
9)	<channel type>	{0 ... 2}	[1]	Channel type indication
		0 – DPDCH		D edicated P hysical D ata C hannel
		1 – DPCCH		D edicated P hysical C ontrol C hannel
		2 – HS-DPCCH		H igh- S peed D edicated P hysical C ontrol C hannel
		3 – E-DPCCH		E nhanced D edicated P hysical C ontrol C hannel
		4 - E-DPDCH		E nhanced D edicated P hysical D ata C hannel
10)	<modulation type>	{2}	[1]	Modulation type of the code channel
11)	<reserved>	{0}	[1]	Reserved for future functionality.

For TRACE1 or TRACE2 the following measured values are transferred depending on the display mode:

CODE PWR ABSOLUTE / RELATIVE , CHANNEL TABLE (TRACE1)

Each channel is defined by the class, the channel number, the absolute level, the relative level and the timing offset. The class denotes the spreading factor of the channel.

Class 8 corresponds to the highest spreading factor (256, symbol rate 15 ksp/s), class 2 to the lowest admissible spreading factor (4, symbol rate 960 ksp/s).

Five values are transmitted for each channel.

<class>,<channel number>,<absolute level>,<relative level>,<I/Q component>,
.....

For CODE PWR ABSOLUTE / RELATIVE, the channels are output in ascending order sorted according to the code numbers, i.e. in the same sequence as they are displayed on the screen. For CHANNEL TABLE, the channels are sorted according to the code classes, i.e. the unassigned channels are transmitted last.

The units are:

Absolute level dBm,
Relative level dB referred to the total power of the signal.

The example shows the results of a query for three channels with the following configuration:

1st channel: spreading factor 256, channel number 0, component Q

2nd channel: spreading factor 4, channel number 1, component I

3rd channel: spreading factor 4, channel number 1, component Q

This yields the following result: 8,0,-20.0,0.0,0,2,-20.0,0.0,1,2,1,-20.0,0.0,0

The channels come in the same order as in the CDP diagram, i.e. depending on their position in the code domain of spreading factor 256.

CODE DOMAIN ERROR POWER (TRACE1 [Overview OFF] TRACE1 / TRACE2 [Overview ON])

Output: Five values are transmitted for each code class 8 channel. The channels are sorted according to the code numbers

Format: <code class>₁, <code number>₁, <CDEP>₁, <channel flag>₁,
<code class>₂, <code number>₂, <CDEP>₂, <channel flag>₂,
...
<code class>₂₅₆, <code number>₂₅₆, <CDEP>₂₅₆, <channel flag>₂₅₆

Unit: < [1] >, < [1] >, < [dB] >, < [1] >

Range: < 8 >, < 0...256 >, < -∞ ... ∞ >, < 0 ; 1 >

Quantity: 256

Explanation:

code class: [1] Highest code class of an uplink signal. It is always set to 8 (CC8).

code number: [1] Code number of the evaluated CC8 channel.

CDEP: [dB] Code domain error power value of the CC8 channel.

channel flag: [1] Indicates if the CC8 channel belongs to an assigned code channel:

Range: 0b00 0d0 - CC8 is inactive

0b01 0d1 - CC8 channel belongs to an active

code channel

RESULT SUMMARY (TRACE2)

The results of the RESULT SUMMARY are output in the following order:

<composite EVM>,<peak CDE>,<carr freq error>,<chip rate error>,
<total power>,<trg to frame>,<EVM peak channel>,<EVM mean channel>,
<class>, <channel number>,<power abs. channel>,<power rel. channel>,<l/Q component>,
<pilot length>,<IQ offset>,<IQ imbalance>

The units are:

EVM peak channel/mean channel, composite EVM, IQ offset/imbalance : %,

peak CDE, total power and power abs. channel: dB,

power rel. channel: dB referred to the total power of the signal,

carr freq error: Hz,

chip rate error: ppm,

trg to frame: μ s,
 pilot length: bits,
 I/Q component: absolute.

POWER VS SLOT (TPVSlot)

15 pairs of CPICH slot numbers and level values are always transferred. The query is only possible in frame mode and not in slot mode. But it is possible no matter which evaluation screen is selected in the code domain analyzer.

<slot number>, <level value in dBm>,<slot number>,<level value in dBm>,,.....

POWER VS SLOT (TRACE2)

15 pairs of slot (slot number of CPICH) and level values (for 15 slots) are always transferred.

<slot number>, <level value in dB>,<slot number>,<level value in dB>,,.....

SYMBOL EVM (TRACE2)

The number of level values depends on the spreading factor:

Spreading factor 256	10 values	Spreading factor 128	20 values
Spreading factor 64	40 values	Spreading factor 32	80 values
Spreading factor 16	160 values	Spreading factor 8	320 values
Spreading factor 4	640 values		

PEAK CODE DOMAIN ERR and COMPOSITE EVM (TRACE2)

15 pairs of slot (slot number of CPICH) and values are always transferred.

PEAK CODE DOMAIN ERR: <slot number>, <level value in dB>,,.....

COMPOSITE EVM: <slot number>, <value in %>,

SYMBOL CONST(TRACE2)

The real and the imaginary part are transferred as a pair:

<re 0>,<im 0>,<re 1>,<im 1>,,.....<re n>, <im n>

For the channels have exclusively I or Q components in R&S FS-K73, the <re> or <im> values are 0, depending on the selected component.

The number of level values depends on the spreading factor:

Spreading factor 256	10 values	Spreading factor 128	20 values
Spreading factor 64	40 values	Spreading factor 32	80 values
Spreading factor 16	160 values	Spreading factor 8	320 values
Spreading factor 4	640 values		

BITSTREAM (TRACE2)

The bitstream of one slot is transferred. One value is transferred per bit (range 0,1,). The number of symbols is not constant and may vary for each sweep.

Specific symbols in the bitstream may be invalid depending on the channel type and the bit rate (symbols without power). The assigned invalid bits are marked by "9".

EVM VS CHIP (TRACe2)

The square root of square difference between received signal and reference signal for each chip are transferred. The values are normalized to the square root of the average power at the selected slot:

Output: List of vector error values of all chips at the selected slot

Format: VectError0, VectError 1,, VectError 2559

Unit: [%]

Quantity: 2560

MAGNITUDE ERROR VS CHIP (TRACe2)

The magnitude difference between received signal and reference signal for each chip are transferred. The values are normalized to the square root of the average power at the selected slot:

Output: List of magnitude error values of all chips at the selected slot
 Format: MagError0, MagError 1,, MagError 2559
 Unit: [%]
 Quantity: 2560

PHASE ERROR VS CHIP (TRACe2)

The phase differences between received signal and reference signal for each chip are transferred. The values are normalized to the square root of the average power at the selected slot:

Output: List of magnitude error values of all chips at the selected slot
 Format: PhaseError0, PhaseError 1,, PhaseError 2559
 Unit: [°]
 Quantity: 2560

Example: `":TRAC TRACE1,"+A$` (A\$: data list in current format)

`":TRAC? TRACE1"`

Features: *RST value: -
 SCPI: conforming

LIST With this command the list evaluation results are queried in the following order:

<no>, <start>, <stop>, <rbw>, <freq>, <power abs>, <power rel>, <delta>, <limit check>, <unused1>, <unused2>

All results are float values.

no : range number
 start : start frequency
 stop : stop frequency
 rbw : resolution bandwidth of range
 freq : frequency of peak
 power abs : absolut power in dBm of peak
 power rel : relative power in dBc (related to the channel power) of peak
 delta : distance to the limit line in dB (positive indicates value above the limit, fail)
 limit check : limit fail (pass = 0, fail =1)
 unused1 : reserved (0.0)
 unused2 : reserved (0.0)

READ OUT RESULTS OF PEAK LIST EVALUATION

This command reads the peak list of the spectrum emission mask measurement list evaluation (refer to CALC:PEAK:AUTO ON | OFF). An array of values is returned for each range of the limit line. The arrays for each limit line range are following sequentially.

<value array of range 1>, <value array of range 2>,, <value array of range n>

The array of each range contains the following value list:

<No>, <Start>, <Stop>, <Rbw>, <Freq>, <Levelabs>, <Levelrel>, <Delta>, <Limitcheck>, <unused1>, <unused2>

where:

No [] : number of the limit line range
 Start [Hz] : start frequency of the limit line range
 Stop [Hz] : stop frequency of the limit line range
 Rbw [Hz] : resolution band width of the limit line range
 Freq [Hz] : frequency of the power peak with in the range
 Levelabs[dBm] : absolute power of the peak with in the range
 Levelrel[dB] : relative power of the peak with in the range related to channel power.
 Delta [dB] : power difference to margin power
 Limitcheck [0 | 1] : decision whether the power is below [0] or above [1] the limit line
 Unused1[] : reserved (0.0)
 Unused2[] : reserved (0.0)

Example: "TRAC:DATA? LIST" Reads the value list of automatic peaks search

CEVM This command reads the root mean square (RMS) value of the error vector magnitude (EVM_{rms}). The measurement interval of the RMS value depends on analyzer settings and the channel configuration of the applied signal (refer to ":[SENSe:]CDPower:EINterval" and ":[SENSe:]CDPower:ETCHips"). The information of the chip limits of the used measurement interval are given for each slot. Fifteen (15) groups of 6 values are always transferred.

Example: :TRAC:DATA? CEVM

Result: 15 groups with 6 values per group are returned:

```
<slot0>,<EVM0>,<BeginMeas0>,<EndMeas0>,<Reserved_A0>,<Reserved_B0>
<slot1>,<EVM1>,<BeginMeas1>,<EndMeas1>,<Reserved_A1>,<Reserved_B1>
      |           |           |           |           |
<slot14>,<EVM14>,<BeginMeas14>,<EndMeas14>,<Reserved_A14>,<Reserved_B14>
```

where:	<field>	[unitf]	{range}	- explanation
	<slot _n >	[1]	{0 to 14}	- slot number
	<EVM _n >	[%]	{0 to 100}	- RMS value of error vector magnitude
	<BeginMeas _n >	[chip]	{0 to 1278}	- Begin of the measurement interval for EVM _{rms} value
	<EndMeas _n >	[chip]	{0 to 2559}	- End of the measurement interval for EVM _{rms} value
	<Reserved_A _n >	[]	{0}	- Reserved for possible additional information in future FW versions
	<Reserved_B _n >	[]	{0}	- Reserved for possible additional information in future FW versions

8.8 Table of Softkeys with Assignment of IEC/IEEE Commands

3G FDD UE	INSTRument:SElect BWCDpower WCDPower
POWER	:CONFigure<1>:WCDPower:MEASurement POWER Query of results: :CALCulate<1>:MARKer<1>:FUNction:POWer:RESult? CPOWer
ACLR	:CONFigure<1>:WCDPower:MEASurement ACLR Query of results: :CALCulate<1>:MARKer<1>:FUNction:POWer:RESult? ACPOWer
NO. OF ADJ CHAN	:SENSe<1>:POWer:ACHannel:ACPairs 1 Query of results: :SENSe<1>:POWer:ACHannel:ACPairs?
ADJUST SETTINGS	:SENSe<1>:POWer:ACHannel:PRESet ACPOWer
SWEEP TIME	:SENSe<1>:SWEep:TIME <value> Query of results: :SENSe<1>:SWEep:TIME ? Result: <value> [sec]
NOISE CORR ON OFF	:SENSe<1>:POWer:NCORrection ON OFF Query of results: :SENSe<1>:POWer:NCORrection ? Result: <0 1>
FAST ACLR ON OFF	:SENSe<1>:POWer:HSPeed ON OFF Query of results: :SENSe<1>:POWer:HSPeed ? Result: <0 1>
DIAGRAMM FULL SIZE	----
ADJUST REF LVL	:SENSe<1>:POWer:ACHannel:PRESet:RLEVel
ACLRLIMIT CHECK	:CALCulate<1>:LIMit1:ACPoweR ON OFF Query of results: :CALCulate<1>:LIMit1:ACPoweR ? Result: <0 1> Query of results: :CALCulate<1>:LIMit1:ACPoweR:ACHannel:RESult? Result: <PASSED _{Left SB} FAILED _{Left SB} , PASSED _{Right SB} FAILED _{Right SB} > Query of results: :CALCulate<1>:LIMit1:ACPoweR:ALternate<1..2>:RESult? Result: <PASSED _{Left SB} FAILED _{Left SB} , PASSED _{Right SB} FAILED _{Right SB} >
EDIT ACLR LIMIT	:CALCulate<1>:LIMit1:ACPoweR:ACHannel:[RELative] <Val _{left} ,Val _{right} > Query of results: :CALCulate<1>:LIMit1:ACPoweR:ACHannel:[RELative] ? Result: <Val _{left} ,Val _{right} > [dBc] :CALCulate<1>:LIMit1:ACPoweR:ACHannel:[RELative]:STATe ON Query of results: :CALCulate<1>:LIMit1:ACPoweR:ACHannel:[RELative]:STATe ? Result: <0 1> :CALCulate<1>:LIMit1:ACPoweR:ALternate<1..2>:[RELative] <Val _{left} ,Val _{right} > Query of results: :CALCulate<1>:LIMit1:ACPoweR:ACHannel:[RELative] ? Result: <Val _{left} ,Val _{right} > [dBc] :CALCulate<1>:LIMit1:ACPoweR:ALternate<1..2>:[RELative]:STATe ON Query of results: :CALCulate<1>:LIMit1:ACPoweR:ACHannel:[RELative]:STATe ? Result: <0 1> :CALCulate<1>:LIMit1:ACPoweR:ACHannel:ABSolute <Val _{left} ,Val _{right} >

	<pre> Query of results: :CALCulate<1>:LIMit1:ACPoweR:ACHannel:ABSolute ? Result: <Val_1eft,Val_1right> [dBm] :CALCulate<1>:LIMit1:ACPoweR:ACHannel:ABSolute:STATe ON Query of results: :CALCulate<1>:LIMit1:ACPoweR:ACHannel:ABSolute:STATe ? Result: <0 1> :CALCulate<1>:LIMit1:ACPoweR:ALTerNate<1..2>:ABSolute <Val_1eft,Val_1right> Query of results: :CALCulate<1>:LIMit1:ACPoweR:ACHannel:ABSolute ? Result: <Val_1eft,Val_1right> [dBm] :CALCulate<1>:LIMit1:ACPoweR:ALTerNate<1..2>:ABSolute:STATe ON Query of results: :CALCulate<1>:LIMit1:ACPoweR:ACHannel:ABSolute:STATe ? Result: <0 1> </pre>
CHANNEL BANDWIDTH	<pre> :SENSe<1>:POWeR:ACHannel:BWIDth <Value> Hz kHz MHz GHz Query of results: :SENSe<1>:POWeR:ACHannel:BWIDth ? Result: <Value> [Hz] </pre>
ADJ CHAN BANDWIDTH	<pre> :SENSe<1>:POWeR:ACHannel:BWIDth:ACHannel <Value> Hz kHz MHz GHz Query of results: :SENSe<1>:POWeR:ACHannel:BWIDth:ACHannel ? Result: <Value> [Hz] :SENSe<1>:POWeR:ACHannel:BWIDth:ALTerNate<1..2> <Value> Hz kHz MHz GHz Query of results: :SENSe<1>:POWeR:ACHannel:BWIDth:ALTerNate<1..2> ? Result: <Value> [Hz] </pre>
ADJ CHAN SPACING	<pre> :SENSe<1>:POWeR:ACHannel:SPACing[:ACHannel] <Value> Hz kHz MHz GHz Query of results: :SENSe<1>:POWeR:ACHannel:SPACing[:ACHannel] ? Result: <Value> [Hz] :SENSe<1>:POWeR:ACHannel:SPACing:ALTerNate<1..2> <Value> Hz kHz MHz GHz Query of results: :SENSe<1>:POWeR:ACHannel:SPACing:ALTerNate<1..2> ? Result: <Value> [Hz] </pre>
ACLR ABS REL	<pre> :SENSe<1>:POWeR:ACHannel:MODE ABSolute RELative Query of results: :SENSe<1>:POWeR:ACHannel:MODE ? Result: <ABS REL> </pre>
CHAN PWR / Hz	<pre> :CALCulate1:MARKer1:FUNCTion:POWeR:RESult:PHZ ON OFF Query of results: :CALCulate1:MARKer1:FUNCTion:POWeR:RESult:PHZ ? Result: <0 1> </pre>
POWER MODE	<pre> :CALCulate:MARKer:FUNCTion:POWeR:MODE WRITe MAXHold </pre>
SPECTRUM EM MASK	<pre> :CONFIgure:WCDPower:MEASurement ESpectrum Query of results: :CALCulate<1>:LIMit<1>:FAIL? </pre>
LIMIT LINE AUTO	<pre> :CALCulate<1>:LIMit<1>:ESpectrum:MODE AUTO </pre>

LIMIT LINE USER	<pre>:CALCulate:LIMit<1>:NAME <string> :CALCulate:LIMit<1>:UNIT DBM :CALCulate:LIMit<1>:CONTRol[:DATA] <num_value>, <num_value>, ... :CALCulate:LIMit<1>:CONTRol:DOMain FREQUency :CALCulate:LIMit<1>:CONTRol:TRACe 1 :CALCulate:LIMit<1>:CONTRol:OFFset <num_value> :CALCulate:LIMit<1>:CONTRol:MODE RELative :CALCulate:LIMit<1>:UPPer[:DATA] <num_value>, <num_value>.. :CALCulate:LIMit<1>:UPPer:STATe ON OFF :CALCulate:LIMit<1>:UPPer:OFFset <num_value> :CALCulate:LIMit<1>:UPPer:MARGin <num_value> :CALCulate:LIMit<1>:UPPer:MODE ABSolute :CALCulate:LIMit<1>:UPPer:SPACing LINear</pre> <p>Notes:</p> <ul style="list-style-type: none"> - If the y values are entered using the command :CALCulate:LIMit<1>:LOWer[:DATA] the limit check yields "failed" if the values are below the limit line. - If a user-defined limit line is activated, it has priority over limit lines selected via AUTO.
RESTORE STD LINES	:CALCulate<1>:LIMit<1>:ESpectrum:RESTore
LIST EVALUATION	:CALCulate1:PEAKsearch:AUTO ON OFF
ACJUST REF LVL	: [SENSe:]POWer:ACHannel:PRESet:RLEVel
30kHz/1MHz TRANSISTON	:CALCulate<1 2>:LIMit<1...8>:ESpectrum:TRANSition <numeric value>
OCCUPIED BANDWIDTH	:CONFigure<1>:WCDPower:MEASurement OBANDwidth Query of results: :CALCulate<1>:MARKer<1>:FUNCTion:POWer:RESult? OBANDwidth
% POWER BANDWIDTH	:SENSe<1>:POWer:BANDwidth <value> PCT Query of results: :SENSe<1>:POWer:BANDwidth ? Result: <value> [%]
ADJUST REF LVL	:SENSe1:POWer:ACHannel:PRESet:RLEVel
ADJUST SETTINGS	:SENSe1:POWer:ACHannel:PRESet OBWidth
STATISTICS	:CONFigure:WCDPower:MEASurement CCDF or :CALCulate:STATistics:MS:CCDF[:STATe] ON Query of results: CALCulate:MARKer:X?
APD	:CALCulate1:STATistics:APD:STATe ON Query of results: :CALCulate1:STATistics:APD:STATe? Result: <0 1>
CCDF	:CALCulate1:STATistics:CCDF:STATe ON Query of results: :CALCulate1:STATistics:CCDF:STATe? Result: <0 1>
PERCENT MARKER	:CALCulate<1>:MARKer1:Y:PERCent <value> PCT Query of results: :CALCulate<1>:MARKer1:Y:PERCent ? Result: <0..100> [%]
NO OF SAMPLES	:CALCulate<1>:STATistics:NSAMples <value> Query of results: :CALCulate<1>:STATistics:NSAMples ? Result: <value>

SCALING	<pre>:CALCulate<1>:STATistics:NSAMples <value> Query of results: :CALCulate<1>:STATistics:NSAMples ? Result: <value></pre>
X-AXIS REF LEVEL	<pre>:CALCulate<1>:STATistics:SCALE:X:RLEVel <value> dBm Query of results: :CALCulate<1>:STATistics:SCALE:X:RLEVel ? Result: <value> [dBm]</pre>
X-AXIS RANGE	<pre>:CALCulate<1>:STATistics:SCALE:X:RANGE <value> dBm Query of results: :CALCulate<1>:STATistics:SCALE:X:RANGE ? Result: <value> [dBm]</pre>
Y-AXIS MAX VALUE	<pre>:CALCulate<1>:STATistics:SCALE:Y:UPPer <value> Query of results: :CALCulate<1>:STATistics:SCALE:Y:UPPer? Result: <value> Range: [1E-8...1]</pre>
Y-AXIS MIN VALUE	<pre>:CALCulate<1>:STATistics:SCALE:Y:LOWer <value> Query of results: :CALCulate<1>:STATistics:SCALE:Y:LOWer ? Result: <value> Range: [1E-9...0.1]</pre>
ADJUST SETTINGS	<pre>:CALCulate<1>:STATistics:SCALE:AUTO ONCE</pre>
DEFAULT SETTINGS	<pre>:CALCulate<1>:STATistics:PRESet</pre>
ADJUST REF LVL	<pre>:CALCulate<1>:STATistics:PRESet:RLEVel</pre>
ADJUST SETTINGS	<pre>:CALCulate<1>:STATistics:SCALE:AUTO ONCE</pre>
CONT MEAS	<pre>:INITiate<1>:CONTinuous ON Query of results: :INITiate<1>:CONTinuous ? Result: <1 0> :INITiate<1>:IMMediate</pre>
SINGLE MEAS	<pre>:INITiate<1>:CONTinuous OFF Query of results: :INITiate<1>:CONTinuous ? Result: <0 1> :INITiate<1>:IMMediate</pre>
CODE DOM POWER	<pre>:INSTrument<1>[:SElect] WCDPower or :CONFigure:WCDPower:MEASurement WCDPower Query of results: :TRACe:DATA? TRACE1 TRACE2 ABITstream CTABLE or :CALCulate<1 2>:MARKer<1>:FUNctioN:WCDPower:RESult? PTOTal FERRor TFRame TOFFset MACCuracy PCDError EVMRms EVMPeak CERRor CSLot SRATe CHANnel CDPabsolute CDPRelative IQOffset IQIMbalance or marker functions (see submenu MARKER)</pre>
RESULT SUMMARY	<pre>:CALCulate2:FEED "XTIM:CDP:ERR:SUMMARY" Query of results: :CALCulate:MARKer:FUNctioN:WCDPower:MS:RESult? PTOTal FERRor TFRame MACCuracy PCDError EVMRms EVMPeak CERRor CSLot SRATe CHANnel CDPabsolute CDPRelative IQOffset IQIMbalance TOFFset RHO</pre>

SELECT I Q	:[SENSe:]CDPower:CMApping I Q
SELECT CHANNEL	:[SENSe:]CDPower:CODE 0...511
ADJUST REF LVL	:SENSe1:POWer:ACHannel:PRESet:RLevel
CODE DOM ERROR	:CALCulate1:FEED 'XPOWer:CDEP' Query of results:, :TRACe<1>:DATA? TRACe<1 2> Format: <code class> ₁ , <code number> ₁ , <CDEP> ₁ , <channel flag> ₁ , <code class> ₂ , <code number> ₂ , <CDEP> ₂ , <channel flag> ₂ , <code class> ₂₅₆ , <code number> ₂₅₆ , <CDEP> ₂₅₆ , <channel flag> ₂₅₆ Unit: < [1] >, < [1] >, < [dB] >,< [1] > Range: < 8 > , < 0...256 >, < -∞ ... ∞ >, < 0 ; 1 > Quantity: 256
CODE PWR OVERVIEW	:[SENSe:]CDPower:OVERview ON OFF :CALCulate<1>:FEED 'XPOW:CDP:OVERview'
CHANNEL TABLE	:CALCulate<1>:FEED "XTIM:CDP:ERR:CTABLE"
CHAN CONF	--
CODE CHAN AUTOSEARCH	:CONFigure:WCDPower:MS:CTABLE[:STATe] OFF
CODE CHAN PREDEFINED	:CONFigure:WCDPower:MS:CTABLE[:STATe] ON :CONFigure:WCDPower:MS:CTABLE:SElect <channel table name>
EDIT CHAN CONF TABL	
HEADER VALUES	HEADER :CONFigure:WCDPower:MS:CTABLE:NAME "channel table name" :CONFigure:WCDPower:MS:CTABLE:COMment "Comment for new table" VALUES :CONFigure:WCDPower:MS:CTABLE:NAME "channel table name" :CONFigure:WCDPower:MS:CTABLE:DATA <numeric_value>
MEAS CHAN CONF TABLE	--
SAVE TABLE	-- (automatically if using remote control)
NEW CHAN CONF TABL	please refere to EDIT CHAN CONF TABLE
DEL CHAN CONF TABLE	:CONFigure:WCDPower:MS:CTABLE:NAME "channel table name" :CONFigure:WCDPower:MS:CTABLE:DElete
COPY CHAN CONF TABLE	:CONFigure:WCDPower:MS:CTABLE:NAME "channel table name" :CONFigure:WCDPower:MS:CTABLE:COpy "new channel table name"
SETTINGS	--
SCRAMBLING CODE	:[SENSe:]CDPower:LCODE[:VALue] #H0 ... #H1fff<hex>
FORMAT HEX DEC	:[SENSe<1 2>:]CDPower:LCODE[:VALue] <hex> (scrambling code hex) :[SENSe<1 2>:]CDPower:LCODE:DVALue <numeric_value> (scrambling code dec)

SCR TYPE LONG SHRT	:[SENSe:]CDPower:LCODE:TYPE LONG SHORT
MEASURE SLOT FRAME	:[SENSe:]CDPower:BASE SLOT FRAME
CODE PWR ABS REL	<i>Absolute</i> :CALCulate<1>:FEED `XPOW:CDP` :CALCulate<1>:FEED `XPOW:CDP:ABS` <i>Relative</i> :CALCulate<1>:FEED `XPOW:CDP:RAT`
MULTI FRM CAPTURE	---
FRAME TO ANALYZE	:[SENSe:]CDPower:FRAME[:VALue] <numeric value>
CAPTURE LENGTH	:[SENSe:]CDPower:IQLength <numeric value>
SELECT I Q	:[SENSe:]CDPower:CMApPping I Q
SELECT CHANNEL	:[SENSe:]CDPower:CODE 0...511
SELECT SLOT	:[SENSe:]CDPower:SLOT 0 ... 14
ADJUST REF LVL	SENS:POW:ACH:PRES:RLEV
RRC FILTER ON OFF	:[SENSe:]CDPower:FILTer ON OFF
HS-DPA/UPA ON OFF	:[SENSe:]CDPower:HSDPamode ON OFF
ELEMENTARE TAIL CHIPS	:[SENSe:]CDPower:ETChips ON OFF
SIDE BAND NORM INV	:[SENSe:]CDPower:SBANd NORMal INVerse
NORMALIZE ON OFF	:[SENSe:]CDPower:NORMAlize ON OFF
RESULTS	--
CODE DOM POWER	<i>Absolute</i> :CALCulate<1>:FEED `XPOW:CDP` :CALCulate<1>:FEED `XPOW:CDP:ABS` <i>Relative</i> :CALCulate<1>:FEED `XPOW:CDP:RAT`
COMPOSITE EVM	:CALCulate2:FEED "XTIM:CDP:MACCuracy"
COMPOSITE SIGNAL	---
PEAK CODE DOMAIN ERR	:CALCulate2:FEED "XTIM:CDP:ERR:PCDomain"

EVM VS CHIP	<pre>CALCulate2:FEED "XTIM:CDP:CHIP:EVM" Query of result: :TRACe:DATA? TRACe2 UNIT: [%] Range: [0% ... 100%]</pre>
MAG ERROR VS CHIP	<pre>:CALCulate2:FEED "XTIM:CDP:CHIP:MAGNitude" Query of result: :TRACe:DATA? TRACe2 UNIT: [%] Range: [-100% ... 100%]</pre>
PHASE ERR VS CHIP	<pre>CALCulate2:FEED "XTIM:CDP:CHIP:PHASe" Query of result: :TRACe:DATA? TRACe2 UNIT: [°] Range: [-180° ... 180°]</pre>
COMPOSITE CONST	<pre>:CALCulate2:FEED "XTIM:CDP:COMP:CONS" Query of result: :TRACe:DATA? TRACe2 Output: List of I/Q values of all chips per slot Format: Re₁,Im₁,Re₂,Im₂,...,Re₂₅₆₀,Im₂₅₆₀ Unit: [1] :CALCulate2:FEED "XTIM:CDP:PVSLOT"</pre>
POWER VS SLOT	
RESULT SUMMARY	<pre>:CALCulate2:FEED "XTIM:CDP:ERR:SUMMARY" Query of results: :CALCulate:MARKer:FUNCTION:WCDPower:MS:RESult? PTOTal FERRor TFRame MACCuracy PCDError EVMRms EVMPeak CERRor CSLOT SRATe CHANnel CDPabsolut CDPRelative IQOFFset IQIMbalance TOFFset RHO</pre>
CODE DOM ERROR	<pre>:CALCulate1:FEED 'XPOWER:CDEP' Query of results: :TRACe<1>:DATA? TRACe<1 2> Format: <code class>₁, <code number>₁, <CDEP>₁, <channel flag>₁, <code class>₂, <code number>₂, <CDEP>₂, <channel flag>₂, <code class>₂₅₆, <code number>₂₅₆, <CDEP>₂₅₆, <channel flag>₂₅₆ Unit < [1] >, < [1] >, < [dB] >, < [1] > Range: < 8 >, < 0...256 >, < -∞ ... ∞ >, < 0 ; 1 > Quantity: 256</pre>
CODE PWR OVERVIEW	<pre>:[SENSe:]CDPower:OVERview ON OFF :CALCulate<1>:FEED `XPOW:CDP:OVERview`</pre>
CHANNEL TABLE	<pre>:CALCulate<1>:FEED "XTIM:CDP:ERR:CTABLE"</pre>
FREQ ERR VS SLOT	<pre>:CALCulate<2>:FEED XTIM:CDP:FVSLot</pre>
PHASE DISCOUNT	<pre>:CALCulate<2>:FEED XTIM:CDP:PSVSLot Trace readout via :TRAC? TRACe2</pre>
SYMBOL CONST	<pre>:CALCulate<2>:FEED "XTIM:CDP:SYMB:CONSTellation"</pre>
SYMBOL EMV	<pre>---</pre>

SYMBOL EVM	:CALCulate<2>:FEED "XTIM:CDP:SYMBOL:EVM"
SYMB MAG ERROR	:CALCulate<2>:FEED XTIM:CDP:SYMBOL:EVM:MAGNitude
SYMB PHASE ERROR	:CALCulate<2>:FEED XTIM:CDP:SYMBOL:EVM:PHASe
BITSTREAM	:CALCulate<2>:FEED "XTIM:CDP:SYMB:BITStream"
POWER VS SYMBOL	:CALCulate<1>:FEED "XTIM:CDP:PVSyMbol"
SELECT I Q	:[SENSe:]CDPower:CMAPping I Q
SELECT CHANNEL	:[SENSe:]CDPower:CODE 0...511
SELECT	---
CAPTUE LENGTH	:[SENSe:]CDPower:IQLength <numeric value> Range: R&S FSU / FSP-B70 (<i>free run</i>): <numeric value> [1 ... 2] R&S FSU / FSP-B70 (<i>ext. Trig</i>): <numeric value> [1 ... 3] R&S FSQ: <numeric value> [1 ... 100] R&S FSMR (<i>free run</i>): <numeric value> [1 ... 2] Unit: <numeric value> [0 ... CAPTURE_LENGTH - 1]
FRAME TO ANALYZE	:[SENSe:]CDPower.FRAME[:VALue] <numeric value>
SLOT RES HALF FULL	:[SENSe:]CDPower:HSLot ON OFF
SELECT SLOT	:[SENSe:]CDPower:SLOT 0 ... 14
ADJUST REF LVL	:[SENSe:]POWER:ACHannel:PRESet:RLEVel

9 Performance Test

- Switch off the R&S analyzers before removing or inserting modules.
- Check the setting of the AC supply voltage selector (230 V) prior to switching on the unit.
- Measure the parameters after a warm-up time of at least 30 min. and the completion of system error correction of the analyzer and R&S SMIQ. Only then is it ensured that the specifications are complied with.
- Unless specified otherwise all settings are made after a PRESET.
- Conventions for settings on the analyzer during the measurement:

[<TASTE>] Press a key on the front panel, e.g. [SPAN]

[<SOFTKEY>] Press a softkey, e.g. [MARKER -> PEAK]

[<nn Unit>] Enter a value and terminate by entering the unit, e.g. [12 kHz]

{<nn>} Enter values indicated in one of the following tables

Aufeinanderfolgende Eingaben sind durch [:] getrennt, z.B. [**SPAN**: 15 kHz]

The values stated hereinafter are not guaranteed values. Only the data sheet specifications are binding.

9.1 Required Measuring Equipment and Accessories

Table 9-1: Required Measuring Equipment and Accessories

Item	Instrument type	Recommended characteristics	Recommended equipment	R&S Order No.
1	Signal generator	Vector signal generator for generating WCDMA signals	R&S SMIQ with options: R&S SMIQB42 R&S SMIQB20 R&S SMIQB11	1125.5555.xx 1104.7936.02 1125.5190.02 1085.4502.04

9.2 Test Procedure

The performance test refers exclusively to results of the code-domain power. It is not required to check the POWER-, ACLR- and SPECTRUM results since they are covered by the performance test of the basic unit.

Default settings on R&S SMIQ:

```

[PRESET]
[LEVEL :      0 dBm]
[FREQ:      1.935 GHz]
DIGITAL STD
  WCDMA 3GPP
    LINK DIRECTION  UP/REVERSE
    TEST MODELS (NOT STANDARDIZED)...
      C+D960K
    SELECT BS/MS
      MS 1 ON
    OVERALL SYMBOL RATE... 6960
  STATE: ON
    Trigger output: RADIO FRAME
  
```

The channel list should show the following:

CHANNEL NUMBER	1	2	3	4	5	6
TYPE	DPDCH	DPDCH	DPDCH	DPDCH	DPDCH	DPDCH
SYMBOL RATE	960	960	960	960	960	960
CHAN CODE	1	1	3	3	2	2
DATA	PN15	PN15	PN15	PN15	PN15	PN15

Default settings on the analyzer:

```

[PRESET]
[CENTER:      1.935 GHz]
[REF:      10 dBm]
[3G FDD UE]
[TRIG      EXTERN]
[SETTINGS      SCRAMBLING CODE 0]
[RESULTS      CHANNEL TABLE]
  
```

- Test setup and other settings
- ▶ Connect external trigger input of the analyzer to R&S SMIQ.
 - ▶ Connect external reference output of R&S FSU to R&S SMIQ.

R&S SMIQ

```

UTILITIES
  REF OSC
    SOURCE: EXT
  analyzer [SETUP:      REFERENCE INT]
  
```

The display of the analyzer should show the following:

		SR 960 ksp/s						
		Chan Code 2						
CF 1.935 GHz		Slot # 0		Mapping Q				
Channel Table								
	Type	Symb Rate	Chan#	Status	Mapping	PilotL	Pwr Abs	Pwr Rel
Ref	DPCCCH	15.0 ksp/s	0	active	Q	8	-10.20	-8.45
6.80	DPDCH	960.0 ksp/s	1	active	I	---	-10.21	-8.45
dBm	DPDCH	960.0 ksp/s	1	active	Q	---	-10.21	-8.46
Att*	DPDCH	960.0 ksp/s	2	active	I	---	-10.21	-8.45
5 dB	DPDCH	960.0 ksp/s	2	active	Q	---	-10.21	-8.45
	DPDCH	960.0 ksp/s	3	active	I	---	-10.20	-8.45
	DPDCH	960.0 ksp/s	3	active	Q	---	-10.20	-8.45
1	-----	15.0 ksp/s	0	inactv	I	---	-64.34	-62.59
CLRWR	-----	15.0 ksp/s	1	inactv	I	---	-65.94	-64.18
	-----	15.0 ksp/s	1	inactv	Q	---	-65.36	-63.60

		SR 960 ksp/s						
		Chan Code 2						
CF 1.935 GHz		Slot # 0		Mapping Q				
Result Summary								
GLOBAL RESULTS								
Ref	Total Power	-1.75 dBm	Carrier Freq Error	-67.68 mHz				
6.80	Chip Rate Error	-0.55 ppm	Trigger to Frame	-72.17 ns				
dBm	IQ Offset	0.02 %	IQ Imbalance	0.06 %				
Att*	Composite EVM	1.39 %	Pk CDE (15.0 ksp/s)	-59.06 dB				
5 dB	Slot No	0	No of Active Chan	7				
CHANNEL RESULTS								
	Symbol Rate	960.00 ksp/s	Timing Offset	0 Chips				
1	Channel Code	2	Mapping	Q				
CLRWR	No of Pilot Bits	0	Channel Power Rel	-8.45 dB	Channel Power Abs	-10.21 dBm		
	Channel Power Rel	-8.45 dB	Symbol EVM	1.23 % rms	Symbol EVM	4.86 % Pk		

Date: 25.MAR.2002 11:22:31

10 Glossary

Composite EVM

In accordance with the 3GPP specifications, the squared error between the real and imaginary parts of the test signal and an ideal reference signal is determined (EVM referred to the total signal) in a composite EVM measurement.

DPCCH

Dedicated physical control channel, control channel. The DPCCH contains pilot, TFCI, TPC and FBI bits. The control channel is assumed to be present in every signal in R&S FS-K73.

Dedicated physical control channel, control channel. The DPCCH contains pilot, TFCI, TPC and FBI bits. The control channel is assumed to be present in every signal in R&S FS-K73.

Inactive Channel Threshold

Minimum power that a single channel must have as compared to the total signal to be recognized as an active channel.

Peak Code Domain Error

In accordance with the 3GPP specifications, the error between the test signal and the ideal reference signal is projected onto the classes of the different spreading factors in the case of a peak code domain measurement.

11 Index

* (enhancement label).....	96, 117	center	89
ACLR.....	29	Frequenz	
ACP measurement.....	29	Offset.....	89
Adjacent-channel power	29	Funktionsfelder	52
Amplitude Power Distribution	44	<i>Hotkey</i>	
Amplitude probability distribution	45	3GPP FDD UE.....	24
Anzahl		CHAN CONF.....	24, 79
aktive Kanäle	61	EXIT 3GPP.....	24
Pilot-Bits	61	RESULTS.....	24, 50
APD function.....	45	SETTINGS	24, 84
Attenuation	91	IQ Offset	60
Average Power of Inactive Channels	60	Key	
Averaging	96	AMPT	90
Bandwidth		BW	94
occupied	41	FILE.....	98
Befehle		FREQ.....	89
Zuordnung zu Softkey.....	140	LINES.....	97
Bitstream	75	MARKER.....	92
CCDF		MEAS	27, 94
Complementary Cumulative Distribution Function.....	44	MKR FCTN.....	94
CCDF function	45	MKR→.....	93
Center frequency	89	SPAN	90
Step size.....	89	SWEEP	94
Chan #.....	69	TRACE.....	95
Chan Mapping	61	TRIG.....	94
Channel		Limit	
Bandwidth.....	34	probability range	46
number	30	Mapping.....	69, 81
Power		Marker	
Absolute/relative.....	35	peak	93
Spacing	35	zoom	92
status.....	81	Max hold.....	95
Channel assignment table.....	67	Maximum search	93
Channel Code.....	61	Menü-Übersicht	24
Channel number	81	Messaufbau	20
Channel power		Min hold.....	96
relative.....	81	Nachbarkanalleistung	29
Channel, active	151	No of Active Chan	61
Clear/Write mode.....	95	No of Pilot Bits	61
Code domain error power	64	Offset	
Code domain power.....	53	Frequenz	89
Commands		reference level	91
description	99	Peak code domain error.....	55
Complementary cumulative distribution function.....	45	Peak search.....	93
Composite EVM.....	54	Performance Test	148
Default		Pilot bits.....	81
scalings of x- and y-axis.....	47	PilotL	69
Default setting		Power	
preset	10	adjacent-channel power.....	29
Display range		Power bandwidth percentage.....	42
frequency.....	89	Power measurement	
Distribution function	45	Fast	32
Distribution function of signal amplitudes	44	Power of the 3GPP FDD signal.....	38
Error Vector Mag Pk / rms.....	61	Preset.....	10
Fast power measurement	32	Pwr Abs / Pwr Rel.....	69
Frequenz		RECENT.....	79

Reference level			
channel power	42, 78		
offset	91		
remote			
command99, 101, 102, 103, 104, 105, 106, 107, 108, 109,			
110, 111, 112, 113, 114, 115, 116, 117, 118, 119, 120,			
121, 122, 123, 124, 125, 126, 127, 128, 129, 130, 131,			
132			
Remote control.....	99		
RF attenuation	91		
Sample number	45		
SCPI.99, 101, 102, 103, 104, 105, 106, 107, 108, 109, 110,			
111, 112, 113, 114, 115, 116, 117, 118, 119, 120, 121, 122,			
123, 124, 125, 126, 127, 128, 129, 130, 131, 132			
Scrambling code.....	84		
Search			
peak	93		
Sensitivity			
APD measurement	47		
CCDF measurement.....	47		
Signal amplitudes, distribution function	44		
Signal statistics	44		
softkey			
remote .. 99, 101, 102, 103, 104, 105, 106, 107, 108, 109,			
110, 111, 112, 113, 114, 115, 116, 117, 118, 119, 120,			
121, 122, 123, 124, 125, 126, 127, 128, 129, 130, 131,			
132			
Softkey			
% POWER BANDWIDTH.....	42, 125		
30kHz/1MHz TRANSITION.....	40, 108		
ACLR.....	27, 29		
ACLR ABS / REL.....	35		
ACLR LIMIT CHECK	33		
ADJ CHAN BANDWIDTH	34		
ADJ CHAN SPACING.....	35		
ADJUST REF LVL	33, 40, 42, 78, 90		
ADJUST SETTINGS.....	43, 47		
ALL MARKER OFF.....	92		
APD ON/OFF.....	45		
AVERAGE	96		
BITSTREAM.....	75, 133		
CAPTURE LENGTH.....	87		
CAPTURE LENGTH.....	77		
CCDF ON/OFF.....	45		
CENTER.....	89		
CHAN PWR / HZ.....	36		
CHAN TABLE HEADER	112		
CHAN TABLE VALUES.....	113		
CHANNEL BANDWIDTH.....	34		
CHANNEL TABLE	67, 133		
CLEAR/WRITE	37, 95		
CODE CHAN AUTOSEARCH.....	79		
CODE CHAN PREDEFINED	79		
CODE DOM ERROR.....	64		
CODE DOM POWER.....	28, 53		
CODE PWR ABS / REL.....	85		
CODE PWR ABSOLUTE.....	133		
CODE PWR OVERVIEW.....	66, 133		
CODE PWR RELATIVE.....	133		
COMPOSITE CONST.....	59		
COMPOSITE EVM.....	54, 133		
CONT MEAS	47		
COPY CHAN CONF TABLE	83		
DEFAULT SETTINGS	47		
DEL CHAN CONF TABLE	83		
DIAGRAM FULL SIZE	33		
EDIT ACLR LIMIT.....	33, 103, 104		
EDIT ACLR LIMITS	105		
EDIT CHAN CONF TABLE.....	80, 114		
ELIMINATE TAIL CHIPS	88, 119		
EVM VS CHIP	56		
FAST ACLR ON / OFF.....	32		
FORMAT HEX / DEC.....	85		
FRAME TO ANALYZE.....	77, 87		
FREQ ERR VS SLOT	69		
FREQUENCY OFFSET	89		
HEADER / VALUES.....	81		
HS-DPA/UPA ON / OFF	88		
HS-DPA/UPA ON/OFF	115		
INSTALL OPTION	8		
LIMIT LINE AUTO.....	39, 107		
LIMIT LINE USER.....	39, 107		
LIST EVALUATION	40		
MAG ERROR VS CHIP	57		
MANUAL	90		
MARKER 1 to 4	92		
MARKER NORM/DELTA.....	92		
MARKER ZOOM	92		
MAX HOLD.....	37, 95		
MEAS CHAN CONF TABLE	82		
MEASURE SLOT / FRAME.....	85		
MIN HOLD.....	96		
MULTI FRAME CAPTURE	86		
NEW CHAN CONF TABLE.....	82		
NEXT MODE LEFT/RIGHT.....	93		
NEXT PEAK	93		
NO OF SAMPLES	45		
NO. OF ADJ CHAN	30, 124		
NOISE CORR ON/OFF.....	32		
NORMALIZE ON / OFF	88		
OCCUPIED BANDWIDTH	28, 41		
OPTIONS	8		
PEAK.....	93		
PEAK CODE DOMAIN ERR.....	55, 133		
PEAK MODE MIN/MAX	94		
PERCENT MARKER	45		
PHASE DISCONT	70		
PHASE ERROR VS CHIP	58		
POWER.....	27, 28		
POWER MODE	37		
POWER VS SLOT.....	59, 133		
POWER VS SYMBOL	75		
REF LEVEL	90		
REF LEVEL OFFSET	91		
REF VALUE POSITION.....	91		
RESTORE STD LINES	40		
RESULT SUMMARY	60, 133		
RF ATTEN AUTO	91		
RF ATTEN MANUAL	91		
SAVE TABLE.....	82		
SCALING.....	46		
SCR TYPE LONG / SHRT.....	85		
SCRAMBLING CODE.....	84		
SCREEN A	97		

SCREEN B.....	97	Stepsize	
SELECT CHANNEL.....	76	center frequency	89
SELECT I / Q.....	76	Symbol constellation	72
SELECT I/Q.....	122	Symbol Error Vector Magnitude	73
SELECT MARKER	93	Symbol rate	81
SIDE BAND NORM / INV.....	88	Symbol Rate.....	69
SINGLE MEAS	47	Symbolrate	61
SLOT RES HALF / FULL	78	<i>Taste</i>	
SPECTRUM EM MASK.....	27, 38	DISP.....	97
STATISTICS.....	28, 44	TRACE.....	95
SWEEP TIME.....	32	Timing Offset	61
SYMB MAG ERROR	73	Total power.....	36
SYMB PHASE ERROR.....	74	Total PWR	60
SYMBOL CONST.....	72, 133	Trace	
SYMBOL EVM.....	73, 133	average	96
TRIGGER EXTERN.....	95	Clear/Write	95
VIEW	96, 117	Freeze	96, 117
X-AXIS RANGE.....	46	max hold.....	95
X-AXIS REF LEVEL.....	46	min hold.....	96
Y PER DIV.....	91	Type	69
Y-AXIS MAX VALUE	46	<i>View trace</i>	96, 117
Y-AXIS MIN VALUE.....	46	Zoom	92
Specifications.....	148	Amplitude	96, 117
Status	69		