

R&S® FSV-K7/K7S

Analog Demodulation and FM Stereo Operating Manual

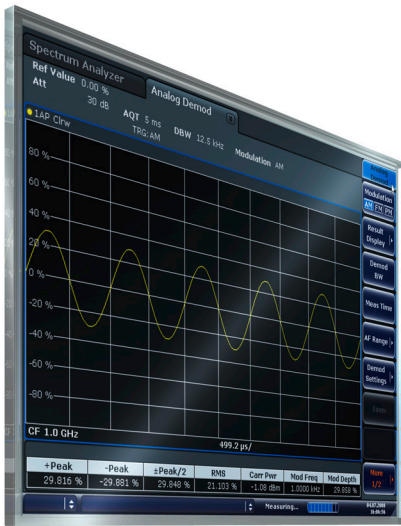

This manual describes the following R&S®FSV/FSVA options:

- R&S FSV-K7 (1310.8103.02)
- R&S FSV-K7S (1310.8126.02)

This manual describes the following R&S FSVA/FSV models with firmware version 3.30 and higher:

- R&S®FSVA4 (1321.3008K05)
- R&S®FSVA7 (1321.3008K08)
- R&S®FSVA13 (1321.3008K14)
- R&S®FSVA30 (1321.3008K31)
- R&S®FSVA40 (1321.3008K41)
- R&S®FSV4 (1321.3008K04)
- R&S®FSV7 (1321.3008K07)
- R&S®FSV13 (1321.3008K13)
- R&S®FSV30 (1321.3008K30)
- R&S®FSV40 (1321.3008K39/1321.3008K40)

It also applies to the following R&S®FSV models. However, note the differences described in [Chapter 1.4, "Notes for Users of R&S FSV 1307.9002Kxx Models"](#), on page 9.

- R&S®FSV3 (1307.9002K03)
- R&S®FSV7 (1307.9002K07)
- R&S®FSV13 (1307.9002K13)
- R&S®FSV30 (1307.9002K30)
- R&S®FSV40 (1307.9002K39/1307.9002K40)

Contents

1	Preface	5
1.1	Documentation Overview.....	5
1.2	Conventions Used in the Documentation.....	6
1.3	How to Use the Help System.....	7
1.4	Notes for Users of R&S FSV 1307.9002Kxx Models.....	9
2	Analog Demodulation Option R&S FSV-K7	10
2.1	Instrument Functions Analog Demodulation.....	10
2.2	Softkeys of the Analog Demodulation option.....	26
2.3	Remote Commands of the Analog Demodulation (R&S FSV-K7).....	81
3	FM Stereo Option R&S FSV-K7S	188
3.1	Instrument Functions FM Stereo (R&S FSV-K7S).....	188
3.2	Remote Commands of the FM Stereo Option (R&S FSV-K7S).....	227
	List of Commands	251
	Index	257

1 Preface

1.1 Documentation Overview

This section provides an overview of the R&S FSVA/FSV user documentation. Unless specified otherwise, you find the documents on the R&S FSVA/FSV product page at:

www.rohde-schwarz.com/manual/FSVA

1.1.1 Quick Start Guide

Introduces the R&S FSVA/FSV and describes how to set up and start working with the product. Includes basic operations, typical measurement examples, and general information, e.g. safety instructions, etc. A printed version is delivered with the instrument. A PDF version is available for download on the Internet.

1.1.2 Operating Manuals and Help

Separate operating manuals are provided for the base unit and the firmware applications:

- Base unit manual
Contains the description of all instrument modes and functions. It also provides an introduction to remote control, a complete description of the remote control commands with programming examples, and information on maintenance, instrument interfaces and error messages. Includes the contents of the getting started manual.
- Firmware application manual
Contains the description of the specific functions of a firmware application. Basic information on operating the R&S FSVA/FSV is not included.

The contents of the operating manuals are available as help in the R&S FSVA/FSV. The help offers quick, context-sensitive access to the complete information for the base unit and the firmware applications.

All operating manuals are also available for download or for immediate display on the Internet.

1.1.3 Service Manual

Describes the performance test for checking the rated specifications, module replacement and repair, firmware update, troubleshooting and fault elimination, and contains mechanical drawings and spare part lists.

The service manual is available for registered users on the global Rohde & Schwarz information system (GLORIS, <https://gloris.rohde-schwarz.com>).

1.1.4 Instrument Security Procedures

Deals with security issues when working with the R&S FSVA/FSV in secure areas. It is available for download on the Internet.

1.1.5 Basic Safety Instructions

Contains safety instructions, operating conditions and further important information. The printed document is delivered with the instrument.

1.1.6 Data Sheets and Brochures

The data sheet contains the technical specifications of the R&S FSVA/FSV. It also lists the firmware applications and their order numbers, and optional accessories.

The brochure provides an overview of the instrument and deals with the specific characteristics.

See www.rohde-schwarz.com/brochure-datasheet/FSV

1.1.7 Release Notes and Open Source Acknowledgment (OSA)

The release notes list new features, improvements and known issues of the current firmware version, and describe the firmware installation.

The open source acknowledgment document provides verbatim license texts of the used open source software.

See www.rohde-schwarz.com/firmware/FSV

1.1.8 Application Notes, Application Cards, White Papers, etc.

These documents deal with special applications or background information on particular topics.

See www.rohde-schwarz.com/application/FSV

1.2 Conventions Used in the Documentation

1.2.1 Typographical Conventions

The following text markers are used throughout this documentation:

Convention	Description
"Graphical user interface elements"	All names of graphical user interface elements on the screen, such as dialog boxes, menus, options, buttons, and softkeys are enclosed by quotation marks.
[Keys]	Key and knob names are enclosed by square brackets.
Filenames, commands, program code	Filenames, commands, coding samples and screen output are distinguished by their font.
<i>Input</i>	Input to be entered by the user is displayed in italics.
Links	Links that you can click are displayed in blue font.
"References"	References to other parts of the documentation are enclosed by quotation marks.

1.2.2 Conventions for Procedure Descriptions

When operating the instrument, several alternative methods may be available to perform the same task. In this case, the procedure using the touchscreen is described. Any elements that can be activated by touching can also be clicked using an additionally connected mouse. The alternative procedure using the keys on the instrument or the on-screen keyboard is only described if it deviates from the standard operating procedures.

The term "select" may refer to any of the described methods, i.e. using a finger on the touchscreen, a mouse pointer in the display, or a key on the instrument or on a keyboard.

1.2.3 Notes on Screenshots

When describing the functions of the product, we use sample screenshots. These screenshots are meant to illustrate as many as possible of the provided functions and possible interdependencies between parameters. The shown values may not represent realistic usage scenarios.

The screenshots usually show a fully equipped product, that is: with all options installed. Thus, some functions shown in the screenshots may not be available in your particular product configuration.

1.3 How to Use the Help System

Calling context-sensitive and general help

- ▶ To display the general help dialog box, press the [HELP] key on the front panel. The help dialog box "View" tab is displayed. A topic containing information about the current menu or the currently opened dialog box and its function is displayed.



For standard Windows dialog boxes (e.g. File Properties, Print dialog etc.), no context-sensitive help is available.

- ▶ If the help is already displayed, press the softkey for which you want to display help.

A topic containing information about the softkey and its function is displayed.



If a softkey opens a submenu and you press the softkey a second time, the submenu of the softkey is displayed.

Contents of the help dialog box

The help dialog box contains four tabs:

- "Contents" - contains a table of help contents
- "View" - contains a specific help topic
- "Index" - contains index entries to search for help topics
- "Zoom" - contains zoom functions for the help display

To change between these tabs, press the tab on the touchscreen.

Navigating in the table of contents

- To move through the displayed contents entries, use the [UP ARROW] and [DOWN ARROW] keys. Entries that contain further entries are marked with a plus sign.
- To display a help topic, press the [ENTER] key. The "View" tab with the corresponding help topic is displayed.
- To change to the next tab, press the tab on the touchscreen.

Navigating in the help topics

- To scroll through a page, use the rotary knob or the [UP ARROW] and [DOWN ARROW] keys.
- To jump to the linked topic, press the link text on the touchscreen.

Searching for a topic

1. Change to the "Index" tab.
2. Enter the first characters of the topic you are interested in. The entries starting with these characters are displayed.
3. Change the focus by pressing the [ENTER] key.
4. Select the suitable keyword by using the [UP ARROW] or [DOWN ARROW] keys or the rotary knob.
5. Press the [ENTER] key to display the help topic.

The "View" tab with the corresponding help topic is displayed.

Changing the zoom

1. Change to the "Zoom" tab.
2. Set the zoom using the rotary knob. Four settings are available: 1-4. The smallest size is selected by number 1, the largest size is selected by number 4.

Closing the help window

- ▶ Press the [ESC] key or a function key on the front panel.

1.4 Notes for Users of R&S FSV 1307.9002Kxx Models

Users of R&S FSV 1307.9002Kxx models should consider the following differences to the description of the newer R&S FSVA/FSV 1321.3008Kxx models:

- Functions that are based on the Windows 10 operating system (e.g. printing or setting up networks) may have a slightly different appearance or require different settings on the Windows XP based models. For such functions, refer to the Windows documentation or the documentation originally provided with the R&S FSV instrument.
- The R&S FSV 1307.9002K03 model is restricted to a maximum frequency of 3 GHz, whereas the R&S FSVA/FSV1321.3008K04 model has a maximum frequency of 4 GHz.
- The bandwidth extension option R&S FSV-B160 (1311.2015.xx) is not available for the R&S FSV 1307.9002Kxx models. The maximum usable I/Q analysis bandwidth for these models is 28 MHz, or with option R&S FSV-B70, 40 MHz.

2 Analog Demodulation Option R&S FSV-K7

Overview of firmware option R&S FSV-K7

This section contains all information required for operation of an R&S FSVA/FSV equipped with Application Firmware R&S FSV-K7. It covers operation via menus and the remote control commands for analog demodulation measurements.

This part of the documentation consists of the following chapters:

- [Chapter 2.1, "Instrument Functions Analog Demodulation"](#), on page 10 describes the overall instrument functions and provides further information
- [Chapter 2.2.1, "Softkeys of the Analog Demodulation Menu"](#), on page 26 shows all softkeys available in the "Analog Demod" menu. This chapter also presents the remote control commands associated with each softkey function.
- The following chapters describe the softkeys of the other keys for the Analog Demodulation option.
- [Chapter 2.3, "Remote Commands of the Analog Demodulation \(R&S FSV-K7\)"](#), on page 81 describes all remote control commands defined for the analog demodulation measurement.

This part of the documentation includes only functions of the Application Firmware R&S FSV-K7. For all other descriptions, please refer to the description of the base unit.

2.1 Instrument Functions Analog Demodulation

The digital signal processing in the R&S FSVA/FSV, used in the analyzer mode for digital IF filters, is also ideally suited for demodulating AM, FM, or PM signals. The firmware option R&S FSV-K7 provides the necessary measurement functions.

The R&S FSVA/FSV is equipped with a demodulator that is capable of performing AM, FM, and PM demodulation at a time. Additionally maximum, minimum and average or current values can be obtained parallel over a selected number of measurements.

By sampling (digitization) already at the IF and digital down-conversion to the base-band (I/Q), the demodulator achieves maximum accuracy and temperature stability. There is no evidence of typical errors of an analog down-conversion and demodulation like AM to FM conversion and vice versa, deviation error, frequency response or frequency drift at DC coupling.

To open the Analog Demodulation menu

- If the "Analog Demodulation" mode is not the active measurement mode, press the [MODE] key and select the "Analog Demodulation" softkey.
- If the "Analog Demodulation" mode is already active, press the [HOME] or [MEAS]key.
The "Analog Demod" menu is displayed (see [Chapter 2.2, "Softkeys of the Analog Demodulation option"](#), on page 26).

Further information

2.1.1	Circuit Description – Block Diagrams.....	11
2.1.2	Demodulation Bandwidth.....	13
2.1.3	Sample Rate, Measurement Time and Trigger Offset.....	13
2.1.4	Variable-Sized Capture Buffer.....	15
2.1.5	AF Trigger.....	16
2.1.6	Configuring Traces.....	16
2.1.7	Trace Mode Overview.....	17
2.1.8	Detector Overview.....	19
2.1.9	Stability of Measurement Results.....	20
2.1.10	Measurement Result Display.....	20
2.1.11	ASCII File Export Format.....	23

2.1.1 Circuit Description – Block Diagrams

The software demodulator runs on the main processor of the analyzer. The demodulation process is shown in [Figure 2-1](#) the figure below. All calculations are performed simultaneously with the same I/Q data set. Magnitude (= amplitude) and phase of the complex I/Q pairs are determined. The frequency result is obtained from the differential phase.

For details on the analyzer signal processing refer to the TRACe : IQ subsystem in the base unit.

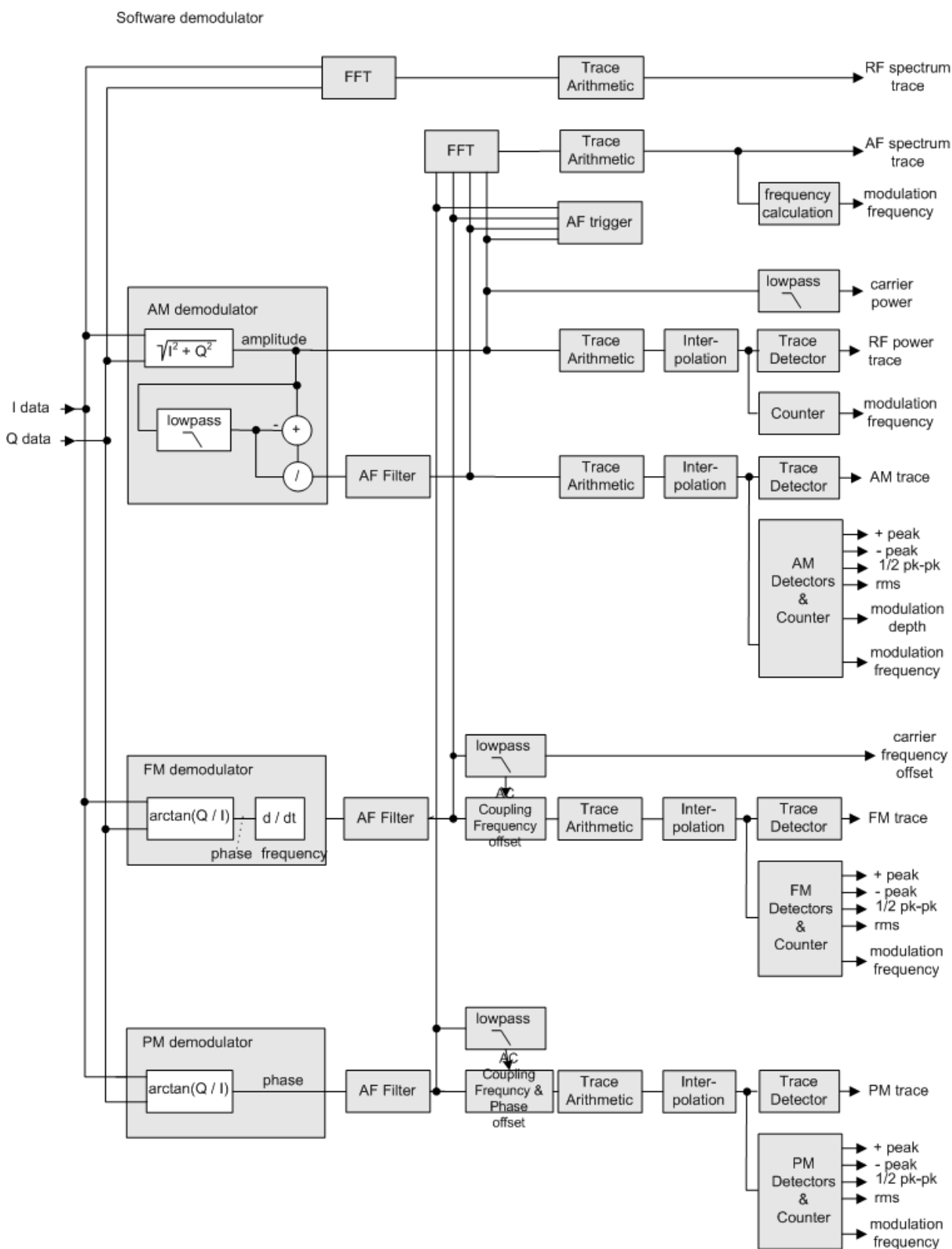

Figure 2-1: Block diagram of software demodulator

The AM DC, FM DC and PM DC raw data of the demodulators is fed into the `Trace Arithmetic` block that combines consecutive data sets. Possible trace modes are: Clear Write, Max Hold, Min Hold and Average (for details refer to [Chapter 2.1.7, "Trace Mode Overview"](#), on page 17. The output data of the `Trace Arithmetic` block can be read via remote control.

The collected measured values are evaluated by the selected detector (for details refer to [Chapter 2.1.8, "Detector Overview"](#), on page 19. The result is displayed on the screen and can be read out via remote control.

In addition, important parameters are calculated:

- A counter determines the modulation frequency for AM, FM, and PM.
- average power = carrier power (RF power)
- average frequency = carrier frequency offset (FM)
- The modulation depth or the frequency or phase deviation is displayed.
- AC coupling is possible with FM and PM display. The deviations are determined from the trace data. +Peak, -Peak, ½ Peak-Peak and RMS are displayed.

2.1.2 Demodulation Bandwidth

The demodulation bandwidth is not the 3 dB bandwidth but the useful bandwidth which is distortion-free with regard to phase and amplitude.

Therefore the following formulas apply:

- AM: demodulation bandwidth $\geq 2 \times$ modulation frequency
- FM: demodulation bandwidth $\geq 2 \times$ (frequency deviation + modulation frequency)
- PM: demodulation bandwidth $\geq 2 \times$ modulation frequency $\times (1 + \text{phase deviation})$



If the center frequency of the analyzer is not set exactly to the signal frequency, the demodulation bandwidth must be selected larger by the carrier offset, in addition to the requirement described above. This also applies if FM or PM AC coupling has been selected.

In general, the demodulation bandwidth should be as narrow as possible to improve the S/N ratio. The residual FM caused by noise floor and phase noise increases dramatically with the bandwidth, especially with FM.

2.1.3 Sample Rate, Measurement Time and Trigger Offset

Depending on the sample rate, the maximum demodulation bandwidths listed in the table can be obtained during the measurement. The permissible value range of the measurement time and trigger offset depends on the selected demodulation bandwidth and demodulation filter. If the AF filter or the AF trigger are not active, the measurement time increases by 20 %.

**Option K7S**

The K7S option always uses the demodulation bandwidth 400 kHz.

Table 2-1: Sample Rate, Measurement Time and Trigger Offset using a flat demodulation filter

Demod. band-width	Sample rate	Measurement time		Trigger offset	
		Min.	Max.	Min.	Max.
160 MHz ¹⁾	200 MHz	5 ns	8 ms	-8 ms	1.0486 s
80 MHz ²⁾	128 MHz	7.8125 ns	12.5 ms	-12.5 ms	1.6384 s
40 MHz ²⁾	64 MHz	15.625 ns	25 ms	-25 ms	3.2768 s
28 MHz	64 MHz	15.625 ns	25 ms	-25 ms	3.2768 s
18 MHz	32 MHz	31.25 ns	50 ms	-50 ms	6.5536 s
10 MHz	32 MHz	31.25 ns	50 ms	-50 ms	6.5536 s
8 MHz	16 MHz	62.5 ns	100 ms	-100 ms	13.1072 s
5 MHz	8 MHz	125 ns	200 ms	-200 ms	26.2144 s
3 MHz	4 MHz	250 ns	400 ms	-400 ms	52.4288 s
1.6 MHz	2 MHz	500 ns	800 ms	-800 ms	104.8576 s
800 kHz	1 MHz	1 µs	1.6 s	-1.6 s	209.7152 s
400 kHz	500 kHz	2 µs	3.2 s	-3.2 s	419.4304 s
200 kHz	250 kHz	4 µs	6.4 s	-6.4 s	838.8608 s
100 kHz	125 kHz	8 µs	12.8 s	-12.8 s	1677.7216 s
50 kHz	62.5 kHz	16 µs	25.6 s	-25.6 s	3355.4432 s
25 kHz	31.25 kHz	32 µs	51.2 s	-51.2 s	6710.8864 s
12.5 kHz	15.625 kHz	64 µs	102.4 s	-102.4 s	13421.7728 s
6.4 kHz	7.8125 kHz	128 µs	204.8 s	-204.8 s	26843.5456 s
3.2 kHz	3.90625 kHz	256 µs	409.6 s	-409.6 s	53687.0912 s
1.6 kHz	1.953125 kHz	512 µs	819.2 s	-819.2 s	107374.1824 s
800 Hz	976.5625 Hz	1.024 ms	1638.4 s	-1638.4 s	214748.3648 s
400 Hz	488.28125 Hz	2.048 ms	3276.8 s	-3276.8 s	429496.7296 s
200 Hz	244.140625 Hz	4.096 ms	6553.6 s	-6553.6 s	858993.4592 s
100 Hz	122.0703125 Hz	8.192 ms	13107.2 s	-13107.2 s	1717986.918 s

¹⁾ only available with option R&S FSV-B160
²⁾ only available with option R&S FSV-B70/R&S FSVA-B40

Table 2-2: Sample Rate, Measurement Time and Trigger Offset using a Gaussian demodulation filter

Demod. band-width	Sample rate	Measurement time		Trigger offset	
		Min.	Max.	Min.	Max.
28 MHz ¹⁾	112 MHz	8.929 ns	14.28 ms	-14.28	1.872457134 s
18 MHz ¹⁾	72 MHz	13.88 ns	22.22 ms	-22.22 ms	2.912711097 s
10 MHz	40 MHz	25 ns	40 ms	-40 ms	5,242879975 s
8 MHz	32 MHz	31.25 ns	50 ms	-50 ms	6.553599969 s
5 MHz	12 MHz	83.33 ns	133.3 ms	-80 ms	10,48575995 s
3 MHz	10.666 MHz	93.75 ns	150 ms	-133.3 ms	17,47626667 s
1.6 MHz	6.4 MHz	156.25 ns	250 ms	-250 ms	32.76799984 s
800 kHz	3.2 MHz	312.5 ns	5 ms	-5 ms	65.53599969 s
400 kHz	1.6 MHz	625 ns	1 s	-1 s	131.0719994 s
200 kHz	800 kHz	1.25 us	2 s	-2 s	262.1439988 s
100 kHz	400 kHz	2.5 us	4 s	-4 s	524.2879975 s
50 kHz	200 kHz	5 us	8 s	-8 s	1048.575995 s
25 kHz	100 kHz	10 us	16 s	-16 s	2097.15199 s
12.5 kHz	50 kHz	20 us	32 s	-32 s	4194.30398 s
6.4 kHz	25.6 kHz	39.0625 us	62.5 s	-62.5 s	8191.999961 s
3.2 kHz	12.8 kHz	78.125 us	125 s	-125 s	16383.99992 s
1.6 kHz	6.4 kHz	156.25 us	250 s	-250 s	32767.99984 s
800 Hz	3.2 kHz	312.5 us	500 s	-500 s	65535.99969 s
400 Hz	1.6 kHz	625 us	1000 s	-1000 s	131071.9994 s
200 Hz	800 Hz	1.25 ms	2000 s	-2000 s	262143.9988 s
100 Hz	400 Hz	2.5 ms	4000 s	-4000 s	524287.9975 s

¹⁾ gaussian filter curve is limited by IQ bandwidth

Large numbers of samples

Principally, the R&S FSVA/FSV can handle up to 1.6 million samples. However, when 480 001 samples are exceeded, all traces that are not currently being displayed on a screen are deactivated to improve performance. The traces can only be activated again when the samples are reduced.

2.1.4 Variable-Sized Capture Buffer

The capture buffer size is now variable. By default, the size of the capture buffer is identical to the defined measurement time. However, if you select a larger capture time manually, you can then scroll through the data in the capture buffer by changing the

offset of the measurement time from the beginning of the capture buffer. The results, which are based on the measurement time, are recalculated automatically based on the new data.

2.1.5 AF Trigger

The analog demodulation option allows triggering to the demodulated signal. The display is stable if a minimum of five modulation periods are within the recording time.

Triggering is always DC-coupled. Therefore triggering is possible directly to the point where a specific carrier level, phase or frequency is exceeded or not attained.

2.1.6 Configuring Traces

- To open the trace wizard, press the TRACE key and then the "Trace Wizard" softkey (see "Trace Wizard" on page 61).

Tip: Context-sensitive menus for traces. Traces have context-sensitive menus. If you right-click on a trace in the display or a trace setting in the information channel bar (or touch it for about 1 second), a menu is displayed which corresponds to the softkey functions available for traces. This is useful, for example, when the softkey display is hidden.

If a menu entry contains an arrow to the right of it, a submenu is available for that entry.

To close the menu, press the ESC key or click in the display outside of the menu.

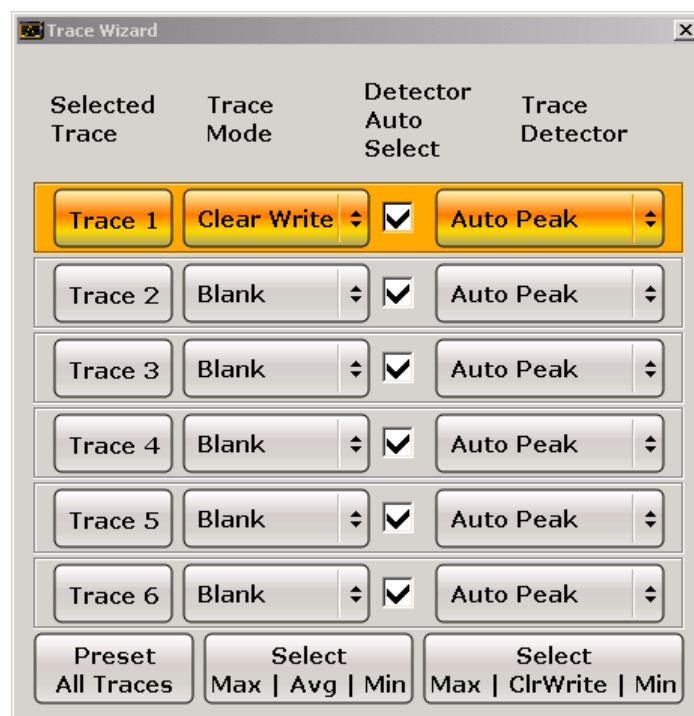

- For each trace you can define the following settings:

Display Mode	<ul style="list-style-type: none"> • Clear Write • Max Hold • Min Hold • Average • View • Blank <p>For details see Chapter 2.1.7, "Trace Mode Overview", on page 17.</p>
Detector Auto Select	Activates automatic detector selection (see Auto Select softkey). If activated, the "Trace Detector" setting is ignored.
Trace Detector	<p>Defines a specific trace detector. If one of the following settings is defined, the "Detector Auto Select" option is deactivated.</p> <ul style="list-style-type: none"> • "Auto Select" on page 59 • "Auto Peak" on page 60 • "Positive Peak" on page 60 • "Negative Peak" on page 60 • "Sample" on page 60 • "RMS" on page 60 • "Average" on page 61 • "Quasipeak" on page 61

3. To configure several traces to predefined display modes in one step, press the button for the required function:

Preset All Traces	<p>Trace 1: Clear Write</p> <p>Trace 2-6: Blank</p>
Select Max Avg Min	<p>Trace 1: Max Hold</p> <p>Trace 2: Average</p> <p>Trace 3: Min Hold</p> <p>Trace 4-6: Blank</p>
Select Max ClrWrite Min	<p>Trace 1: Max Hold</p> <p>Trace 2: Clear Write</p> <p>Trace 3: Min Hold</p> <p>Trace 4-6: Blank</p>

For details see [Chapter 2.1.7, "Trace Mode Overview"](#), on page 17.

2.1.7 Trace Mode Overview

The traces can be activated individually for a measurement or frozen after completion of a measurement. Traces that are not activate are hidden. Each time the trace mode is changed, the selected trace memory is cleared.

The R&S FSVA/FSV offers 6 different trace modes:

Clear Write

Overwrite mode: the trace is overwritten by each sweep. This is the default setting.

All available detectors can be selected.

Remote command:

DISP:TRAC:MODE WRIT, see [DISPlay\[:WINDow<n>\]:TRACe<t>:MODE](#)
on page 110

Max Hold

The maximum value is determined over several sweeps and displayed. The R&S FSVA/FSV saves the sweep result in the trace memory only if the new value is greater than the previous one.

The detector is automatically set to "Positive Peak".

This mode is especially useful with modulated or pulsed signals. The signal spectrum is filled up upon each sweep until all signal components are detected in a kind of envelope.

This mode is not available for statistics measurements.

Remote command:

`DISP:TRAC:MODE MAXH`, see `DISPlay[:WINDow<n>]:TRACe<t>:MODE`
on page 110

Min Hold

The minimum value is determined from several measurements and displayed. The R&S FSVA/FSV saves the smallest of the previously stored/currently measured values in the trace memory.

The detector is automatically set to "Negative Peak".

This mode is useful e.g. for making an unmodulated carrier in a composite signal visible. Noise, interference signals or modulated signals are suppressed whereas a CW signal is recognized by its constant level.

This mode is not available for statistics measurements.

Remote command:

`DISP:TRAC:MODE MINH`, see `DISPlay[:WINDow<n>]:TRACe<t>:MODE`
on page 110

Average

The average is formed over several sweeps. The [Sweep Count](#) determines the number of averaging procedures.

All available detectors can be selected. If the detector is automatically selected, the sample detector is used (see [Chapter 2.1.8, "Detector Overview"](#), on page 19).

This mode is not available for statistics measurements.

Remote command:

`DISP:TRAC:MODE AVER`, see `DISPlay[:WINDow<n>]:TRACe<t>:MODE`
on page 110

View

The current contents of the trace memory are frozen and displayed.

Note: If a trace is frozen, the instrument settings, apart from level range and reference level (see below), can be changed without impact on the displayed trace. The fact that the displayed trace no longer matches the current instrument setting is indicated by the  icon on the tab label.

If the level range or reference level is changed, the R&S FSVA/FSV automatically adapts the measured data to the changed display range. This allows an amplitude zoom to be made after the measurement in order to show details of the trace.

Remote command:

DISP:TRAC:MODE VIEW, see `DISPlay[:WINDow<n>]:TRACe<t>:MODE` on page 110

Blank

Hides the selected trace.

Remote command:

DISP:TRAC OFF, see `DISPlay[:WINDow<n>]:TRACe<t>[:STATe]` on page 111

2.1.8 Detector Overview

The measurement detector for the individual display modes can be selected directly by the user or set automatically by the R&S FSVA/FSV. The detector activated for the specific trace is indicated in the corresponding trace display field by an abbreviation.

The detectors of the R&S FSVA/FSV are implemented as pure digital devices. They collect signal power data within each measured point during a sweep. The default number of sweep points is 691. The following detectors are available:

Table 2-3: Detector types

Detector	Indicator	Function
Auto Peak	Ap	Determines the maximum and the minimum value within a measurement point (not available for SEM)
Positive Peak	Pk	Determines the maximum value within a measurement point
Negative Peak (min peak)	Mi	Determines the minimum value within a measurement point
RMS	Rm	Determines the root mean square power within a measurement point
Average	Av	Determines the linear average power within a measurement point
Sample	Sa	Selects the last value within a measurement point

The result obtained from the selected detector within a measurement point is displayed as the power value at this measurement point.

All detectors work in parallel in the background, which means that the measurement speed is independent of the detector combination used for different traces.



Number of measured values

During a frequency sweep, the R&S FSVA/FSV increments the first local oscillator in steps that are smaller than approximately 1/10 of the bandwidth. This ensures that the oscillator step speed is conform to the hardware settling times and does not affect the precision of the measured power.

The number of measured values taken during a sweep is independent of the number of oscillator steps. It is always selected as a multiple or a fraction of 691 (= default number of trace points displayed on the screen). Choosing less than 691 measured values (e.g. 125 or 251) will lead to an interpolated measurement curve, choosing more than 691 points (e.g. 1001, 2001 ...) will result in several measured values being overlaid at the same frequency position.



RMS detector and VBW

If the RMS detector is selected, the video bandwidth in the hardware is bypassed. Thus, duplicate trace averaging with small VBWs and RMS detector no longer occurs. However, the VBW is still considered when calculating the sweep time. This leads to a longer sweep time for small VBW values. Thus, you can reduce the VBW value to achieve more stable trace curves even when using an RMS detector. Normally, if the RMS detector is used the sweep time should be increased to get more stable trace curves.

2.1.9 Stability of Measurement Results

Despite amplitude and frequency modulation, the display of carrier power and carrier frequency offset is stable.

This is achieved by a digital filter which sufficiently suppresses the modulation, provided, however, that the measurement time is $\geq 3 \times 1 / \text{modulation frequency}$, i.e. that at least three periods of the AF signal are recorded.

The mean carrier power for calculating the AM is also calculated with a digital filter that returns stable results after a measurement time of $\geq 3 \times 1 / \text{modulation frequency}$, i.e. at least three cycles of the AF signal must be recorded before a stable AM can be shown.

2.1.10 Measurement Result Display

In Analog Demodulation mode, the measurement results can be displayed in up to 4 different screens (windows), plus an additional marker table, if applicable. Each screen shows either the measurement results as a diagram or the results of evaluation functions in a table ("Result Summary").

All displays are determined by the I/Q data set recorded for the measurement.

You can define the display configuration for up to 4 different screens at once using the "Display Config" on page 28 softkey.

Screen configuration

For each screen you can define:

- **Off:** Whether it is displayed or not
- **Summary:** Whether a result summary for all screens is displayed instead of a diagram
- **AM/FM/PM/RF Diagrams:** Which type of diagram is displayed

Diagram types

The following diagram types can be selected for display.

- **AM/FM/PM Time Domain**
Selects the AF display in zero span, calculated from the AM, FM, or PM signal.

SCPI command:

```
CALC:FEED 'XTIM:FM' (see CALCulate<n>:FEED on page 90)
```

Displays the demodulated FM signal from trace 1 in screen A.

- **AM/FM/PM Spectrum**
Selects the display of the AF spectrum. The AF spectrum can be calculated from the AM, FM, or PM signal in zero span.

SCPI command:

```
DISP:WIND2:SEL
```

Sets the focus on screen B.

```
CALC2:FEED 'XTIME:FM:AFSPektrum2' (see CALCulate<n>:FEED on page 90)
```

Displays an AF spectrum diagram of the demodulated FM signal from trace 2 in screen B.

- **RF Time Domain**
Selects the display of the RF power in zero span. In contrast to normal analyzer operation, the level values are the magnitude of the I/Q data set.

SCPI command:

```
CALC:FEED 'XTIM:RFP' (see CALCulate<n>:FEED on page 90)
```

- **RF Spectrum**
Selects the display of the RF signal in span > 0. In contrast to normal spectrum analyzer operation, the measured values are determined using FFT from the recorded I/Q data set.

SCPI command:

```
CALC:FEED 'XTIM:SPECTRUM' (see CALCulate<n>:FEED on page 90)
```

Diagram header information

For each diagram, the header provides the following information:

A(FM) 1AP Clrw Ref:0.00 Hz DC
 1 2 3 4 5 6 7 8

1. Screen A/B/C/D
2. Modulation type
3. Trace color
4. Trace number
5. Detector
6. Trace mode
7. Reference value
8. AF coupling (AC/DC), only in AF time domains, if applicable

Result Summary

The result summary displays the results of the evaluation functions for all channels in a table.

D Result Summary							
Carrier Power: -30.00 dBm				Carrier Offset: -1.08 Hz			
	+Peak	-Peak	±Peak/2	RMS	Mod Freq	SINAD	THD
FM	113.87 kHz	-114.06 kHz	113.96 kHz	71.052 kHz	99.999 kHz	54.479 dB	-61.820 dB
PM	1.0028 rad	-1.0024 rad	1.0026 rad	707.15 mrad	99.999 kHz	---	---



Summaries that take up the entire width of the screen are displayed as tables; if only half the screen width is available (2 windows next to each other), the summary is displayed as a list. Thus, the factory-set predefined screen configurations contain only 3 screens: 2 for diagrams and one full-width screen for the summary.

For each channel, the following information is provided:

Label	Description
+Peak	Positive peak (maximum)
-Peak	Negative peak (minimum)
+/-Peak/2	Average of positive and negative peaks
RMS	Root Mean Square value
Mod Freq	Modulation frequency

Label	Description
SINAD	<p>Signal-to-noise and distortion</p> <p>Measures the ratio of the total power to the power of noise and harmonic distortions. The noise and harmonic power is calculated inside the AF spectrum span. The DC offset is removed before the calculation.</p> $SINAD[dB] = 20 \cdot \log \left[\frac{\text{total power}}{\text{noise + distortion power}} \right]$
THD	<p>Total harmonic distortion</p> <p>The ratio of the harmonics to the fundamental and harmonics. All harmonics inside the AF spectrum span are considered up to the tenth harmonic.</p> $THD[dB] = 20 \cdot \log \left[\frac{\sqrt{\sum_{i=2}^{\infty} U_i^2}}{\sqrt{\sum_{i=1}^{\infty} U_i^2}} \right]$

In addition, the following general information for the input signal is provided:

- Carrier Power
- Carrier Offset
- Modulation Depth

2.1.11 ASCII File Export Format

The data of the file header consist of three columns, each separated by a semicolon: parameter name; numeric value; basic unit. The data section starts with the keyword "Trace <n>" (<n> = number of stored trace), followed by the measured data in one or several columns (depending on measurement) which are also separated by a semicolon.



Exporting a single trace vs exporting all traces

Note that the file containing the trace data has a slightly different structure when you export all traces compared to exporting a single trace only. The differences are indicated in the tables below.

Blue font: Information provided when you export a single trace	
Green font: Information provided when you export all traces	
Black font: Information provided regardless of the export mode	
Header	
Type;<instrument_model>;	Instrument model
Version;1.00;	Firmware version
Date;01. Jan 3000;	Date of data set storage
Mode;Receiver;	Application
Start;150000.000000;Hz	Start frequency of the scan
Stop;100000000.000000;Hz;	Stop frequency of the scan
X-Axis;LIN;	Scale of the x-axis
Detector;Average;	Detector type
X-Unit;Hz;	Unit of the x-axis
Y-Unit;dBµV;	Unit of the y-axis
Scan Count;1;	Scan count
Transducer;,,,,,;	Transducer information

Data section (scan ranges)	
Scan 1:	
Start;150000.000000;Hz;	Start frequency of the scan range
Stop;29998500.000000;Hz;	Stop frequency of the scan range
Step;4500.000000;Hz;	Frequency stepsize applied in the scan range
RBW;9000.000000;Hz;	Measurement bandwidth applied in the scan range
Meas Time;0.001000;s;	Measurement time in the scan range
Auto Ranging;OFF;	State of the auto ranging feature
RF Att;10.000000;dB;	Attenuation applied in the scan range
Auto Preamp;OFF; Preamp;0.000000;dB;	Preamplifier information for the scan range
RF Input;1;	RF input used in the scan range
Scan 2:	
(...)	

Data section (traces)	
Trace 1:	
Trace Mode;CLR/WRITE;	Trace mode
Detector;MAX PEAK;	Detector type
X-Unit;Hz;	Unit of the x-axis
Y-Unit;Hz;	Unit of the y-axis
Values;1343;	Number of measurement points
150000.000000;3.541122; 154500.000000;5.776306;[...]	String of results
Trace 2:	
(...)	

Blue font: Information provided when you export a single trace	
Green font: Information provided when you export all traces	
Black font: Information provided regardless of the export mode	
Header	
Type;<instrument_model>;	Instrument model
Version;1.00;	Firmware version
Date;01. Jan 3000;	Date of data set storage
Mode;Analyzer;	Application
Center Freq;100000000.000000;	Center frequency
Freq Offset;0.000000;Hz;	Frequency offset
Span;10000000000.000000;Hz;	Frequency span
X-Axis;LIN;	Scale of the x-axis
Start;150000.000000;Hz;	Start frequency
Stop;2500000.000000;Hz;	Stop frequency
Ref Level;97.000000;dBμV;	Reference level
Level Offset;0.000000;Hz;	Reference level offset
Ref Position;100.000000;%;	Reference position
Y-Axis;LOG;	Scale of the y-axis
Level Range;100.000000;dB;	Range of the y-axis
Rf Att;10.000000;dB;	RF attenuation
RBW;3000000.000000;Hz;	Resolution bandwidth
VBW;300000.000000;Hz;	Video bandwidth
SWT;0.002000;s;	Sweep time
Trace mode;CLR/WRITE;	Trace mode
Detector;AUTOPEAK;	Detector type
X-Unit;Hz;	Unit of the x-axis
Y-Unit;Hz;	Unit of the y-axis
Preamplifier;OFF;	State of the preamplifier
Transducer;OFF;	Transducer information
Sweep Count;0;	Sweep / average count

Data section (traces)	
Trace 1:	
Trace Mode;CLR/WRITE;	Trace mode
Detector;MAX PEAK;	Detector type
X-Unit;Hz;	Unit of the x-axis
Y-Unit;Hz;	Unit of the y-axis
Preamplifier;OFF;	State of the preamplifier
Transducer;OFF;	Transducer information
Values;691;	Number of measurement points
150000.000000;3.541122; 154500.000000;5.776306;[...]	String of results
Trace 2:	
(...)	

2.2 Softkeys of the Analog Demodulation option

Apart from the power measurement menu ([MEAS] key) that is not available in the "Analog Demodulation" mode, all other menus not described here are provided as described for the base unit. For details refer to the corresponding menu descriptions.



Importing and Exporting I/Q Data

I/Q data that was captured in the R&S FSV-K7 application can now be exported to a file on the R&S FSVA/FSV. The stored data can then be imported again at a later time, also by different applications, for further processing.

As opposed to storing trace data, which may be averaged or restricted to peak values, I/Q data is stored as it was captured, without further processing. The data is stored as complex values in 32-bit floating-point format. The I/Q data is stored in a packed format with the file extension `.iq.tar`.

The "Import" and "Export" functions are available from the "Save/Recall" menu, which is displayed when you press the [Save/Rcl] key on the front panel. For details see "Importing and Exporting I/Q Data" in the base unit description.

To display help to a softkey, press the [HELP] key and then the softkey for which you want to display help. To close the help window, press the ESC key. For further information refer to [Chapter 1.3, "How to Use the Help System"](#), on page 7.

• Softkeys of the Analog Demodulation Menu	26
• Softkeys of the Frequency Menu – FREQ Key (Analog Demodulation)	40
• Softkeys of the Span Menu – SPAN Key (Analog Demodulation)	42
• Softkeys of the Amplitude Menu – AMPT Key (Analog Demodulation)	43
• Softkeys of the Auto Set menu - AUTO SET Key (Analog Demodulation)	49
• Softkeys of the Bandwidth Menu – BW Key (Analog Demodulation)	51
• Softkeys of the Sweep Menu – SWEEP Key (Analog Demodulation)	55
• Softkeys of the Trace Menu – TRACE key (Analog Demodulation)	57
• Softkeys of the Trigger Menu – TRIG Key (Analog Demodulation)	63
• Softkeys of the Marker Menu – MKR key (Analog Demodulation)	67
• Softkeys of the Marker Function Menu – MKR FUNC Key (Analog Demodulation)	71
• Softkeys of the Input/Output Menu	76

2.2.1 Softkeys of the Analog Demodulation Menu

The following table shows all softkeys available in the "Analog Demod" menu.

AM.....	28
L Display Config.....	28
L Screen A-D.....	28
L Predefined.....	29
L Add.....	30
L Apply.....	30
L Remove.....	30
L Restore.....	30

L Select Trace.....	30
L Demod BW.....	30
L Meas Time.....	31
L AF Filter.....	31
L High Pass.....	31
L Low Pass.....	31
L Weighting.....	32
L None.....	32
L CCITT.....	32
L CCIR Unweighted.....	32
L CCIR Weighted.....	33
L A Weighted.....	33
L Deemphasis.....	33
L All AF Filter Off.....	34
L AF Range.....	34
L Dev per Division.....	34
L Reference Position.....	34
L Reference Value.....	34
L AF Coupling AC/DC.....	35
L Deviation Lin/Log.....	35
L Unit.....	35
L Phase Unit (Rad/Deg).....	35
L THD Unit (% / DB).....	35
L Abs. Dev Unit (kHz/dBm).....	36
L Rel. Dev Unit (dB / %).....	36
L Time Domain Zoom.....	36
L State On / Off.....	36
L Start.....	36
L Length Manual.....	36
L Length Auto.....	36
L Squelch.....	37
L Squelch Level.....	37
FM.....	37
L Display Config.....	37
L Select Trace.....	37
L Demod BW.....	37
L Meas Time.....	37
L AF Filter.....	37
L AF Range.....	37
L Time Domain Zoom.....	37
L Squelch.....	37
L Squelch Level.....	38
PM.....	38
L Display Config.....	38
L Select Trace.....	38
L Demod BW.....	38
L Meas Time.....	38
L AF Filter.....	38
L AF Range.....	38
L Time Domain Zoom.....	38

L Squelch.....	38
L Squelch Level.....	38
L Zero Phase Reference Point.....	38
L Phase Wrap On/Off.....	39
RF Power.....	39
L Display Config.....	39
L Select Trace.....	39
L Demod BW.....	39
L Meas Time.....	39
L AF Filter.....	39
L AF Range.....	39
L Time Domain Zoom.....	39
L Squelch.....	39
L Squelch Level.....	39
Display Config.....	40

AM

Selects AM as the modulation type, changes the signal display, and opens a submenu to set the measurement configuration.

In single sweep mode, the data is determined from the current I/Q data set, i.e. a change to a different type does not trigger a new measurement.

This menu is also displayed when you press the [MEAS CONFIG] key after changing the modulation type.

Remote command:

CALC:FEED 'XTIM:AM' (see CALCulate<n>:FEED on page 90)

Display Config ← AM

You configure the display settings for the results in the "Display Configuration" dialog box. This dialog box contains the following tabs:

- "Screen A-D": a separate tab for each of the four available screens
- "Predefined": for predefined display configurations

Screen A-D ← Display Config ← AM

For each of the four available screens you can configure what is to be displayed. To define the result display configuration for a screen, select the corresponding tab. For each screen you can define:

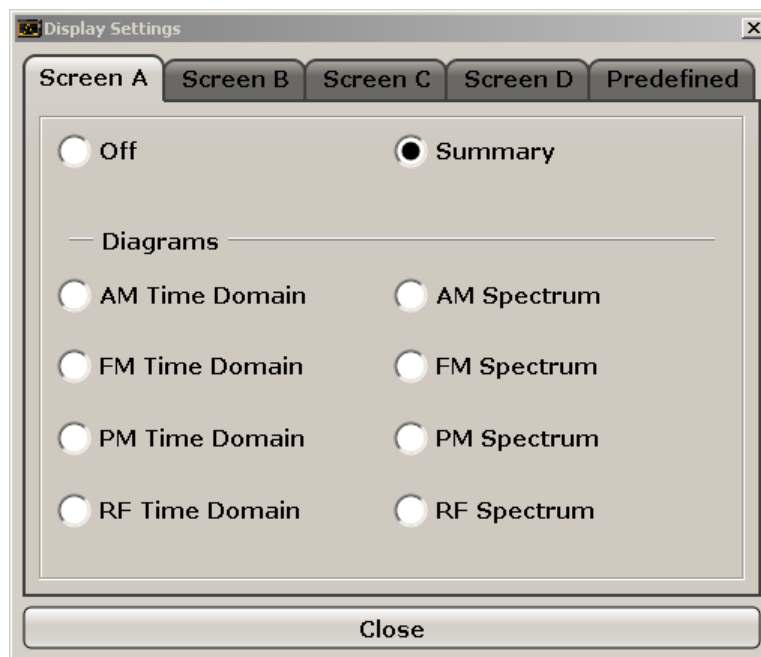

- **Off:** Whether it is displayed or not
- **Summary:** Whether a summary of the evaluation lists from all screens is displayed instead of a diagram
- **AM/FM/PM/RF Diagrams:** Which type of diagram is displayed
For details on the result diagram types, see [Chapter 2.1.10, "Measurement Result Display"](#), on page 20.

Note: By default, the diagram or summary displays the data from trace 1. To change the trace, use the [Select Trace](#) softkey.

Remote command:

`DISP:WIND2:STAT ON` (see `DISPlay[:WINDow<n>]:STATe` on page 109)

Displays second window (Screen B).

`CALC2:FEED 'XTIME:FM:AFSPektrum1'` (see `CALCulate<n>:FEED` on page 90)

Displays an AF spectrum diagram of the demodulated FM signal from trace 1 in screen B.

Predefined ← Display Config ← AM

You can store and load predefined screen configurations. All available configurations are displayed in the "Predefined" tab. The current screen configuration is indicated under "Current" at the top of the list.

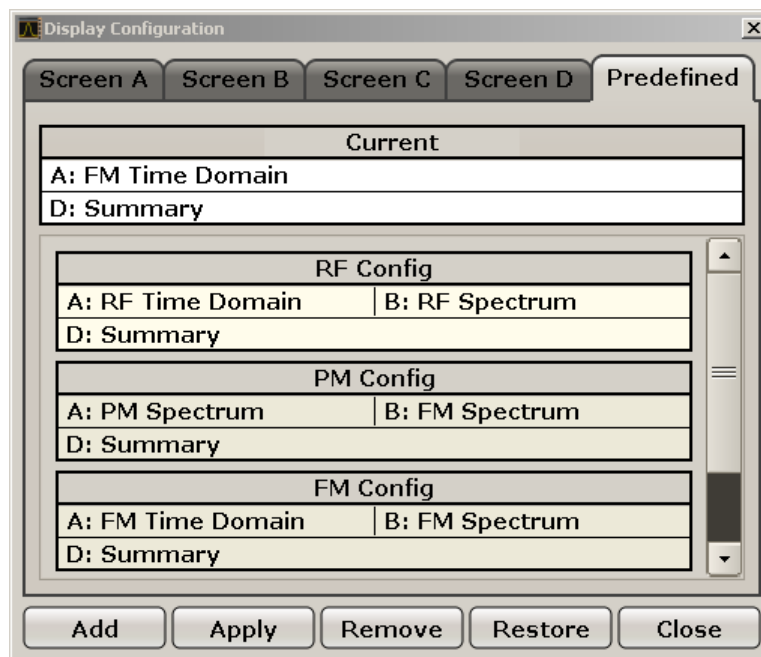
**Add ← Predefined ← Display Config ← AM**

Opens an edit dialog box to enter a name for the current screen configuration. The configuration is then stored and added to the list.

Apply ← Predefined ← Display Config ← AM

Applies the currently selected configuration from the list to the current display.

Remove ← Predefined ← Display Config ← AM

Removes the currently selected configuration from the list.

Restore ← Predefined ← Display Config ← AM

Restores the default display configurations. Existing configurations with the default names are replaced.

Select Trace ← AM

Opens an edit dialog box to enter the number of the trace for which the data is to be displayed in the currently selected screen. Only activated traces can be selected.

Demod BW ← AM

Opens an edit dialog box to enter the demodulation bandwidth of the analog demodulation. The demodulation bandwidth determines the sampling rate for recording the signal to be analyzed. For details on the relation between demodulation bandwidth and sampling rate refer to [Chapter 2.1.3, "Sample Rate, Measurement Time and Trigger Offset"](#), on page 13.

Remote command:

`[SENSe:]BANDwidth|BWIDth:DEMod` on page 147

Meas Time ← AM

Opens an editor for entering the measurement time of the analog demodulation. For details on the measurement time values refer to [Chapter 2.1.3, "Sample Rate, Measurement Time and Trigger Offset"](#), on page 13.

Note: For FM Stereo measurements (option K7S), the minimum measurement time is 2 ms.

Remote command:

[SENSe:] ADEMod:MTIME on page 133

AF Filter ← AM

The bandwidth of the demodulated signal can be reduced by high pass or low pass filters and also a de-emphasis can be switched on. The selected filters are used for AM, FM and PM demodulation in common. Individual settings are not possible.

High Pass ← AF Filter ← AM

Opens the "High Pass" selection list to switch on a high pass filter with the given limit to separate the DC component. The filters are indicated by the 3 dB cutoff frequency. The 50 Hz and 300 Hz filters are designed as 2nd-order Butterworth filter (12 dB/octave). The 20 Hz filter is designed as 3rd-order Butterworth filter (18 dB/octave).

"None" deactivates the AF high pass filter. Default is "None".

The high pass filters are active in the following demodulation bandwidth range:

20 Hz	100 Hz ≤ demodulation bandwidth ≤ 1.6 MHz
50 Hz:	200 Hz ≤ demodulation bandwidth ≤ 3 MHz
300 Hz:	800 Hz ≤ demodulation bandwidth ≤ 8 MHz
Note: for FM stereo (K7S), all filters are active at all times, as the demodulation range is always 400 kHz	

Remote command:

[SENSe:] FILTER<n>:HPASs[:STATe] on page 151

[SENSe:] FILTER<n>:HPASs:FREQuency on page 152

Low Pass ← AF Filter ← AM

Opens the "Low Pass" selection list to select the filter type. Relative and absolute low pass filter are available.

- Absolute low pass filters:
The 3 kHz, 15 kHz; 23 kHz and 150 kHz softkeys switch on a absolute low pass filter. The filters are indicated by the 3 dB cutoff frequency. The 3 kHz, 15 kHz and 23 kHz filters are designed as 5th-order Butterworth filters (30 dB/octave). The 150 kHz filter is designed as 8th-order Butterworth filter (48 dB/octave).
The absolute low pass filters are active in the following demodulation bandwidth range:

3 kHz:	6.4 kHz ≤ demodulation bandwidth ≤ 3 MHz
15 kHz:	50 kHz ≤ demodulation bandwidth ≤ 8 MHz
Note: for FM stereo (K7S), all filters are active at all times, as the demodulation range is always 400 kHz	

23 kHz	$50 \text{ kHz} \leq \text{demodulation bandwidth} \leq 18 \text{ MHz}$
150 kHz:	$400 \text{ kHz} \leq \text{demodulation bandwidth} \leq 8 \text{ MHz}$
Note: for FM stereo (K7S), all filters are active at all times, as the demodulation range is always 400 kHz	

- Relative low pass filters:
The filters (3 dB) can be selected in % of the demodulation bandwidth. The filters are designed as 5th-order Butterworth filter (30 dB/octave) and active for all demodulation bandwidths.
- "None" deactivates the AF low pass filter. Default is "None".

Remote command:

[SENSe:] FILTer<n>:LPASs[:STATe] on page 152

[SENSe:] FILTer<n>:LPASs:FREQuency[:ABSolute] on page 152

[SENSe:] FILTer<n>:LPASs:FREQuency:RELative on page 153

SFM:

[SENSe:] SFM:<ChannelType>:FILTer:LPASs:STATe on page 240

[SENSe:] SFM:<ChannelType>:FILTer:LPASs:FREQuency on page 241

Weighting ← AF Filter ← AM

Opens the "Weighting" selection list to select the weighting AF filter.

None ← Weighting ← AF Filter ← AM

Deactivates the weighting filter. This is the default setting.

Remote command:

[SENSe:] FILTer<n>:HPASs[:STATe] on page 151

CCITT ← Weighting ← AF Filter ← AM

Switches on a CCITT P.53 weighting filter. The weighting filter is active in the following demodulation bandwidth range:

$20 \text{ kHz} \leq \text{demodulation bandwidth} \leq 3 \text{ MHz}$

For FM stereo (K7S), the filter is active at all times, as the demodulation range is always 400 kHz.

Remote command:

[SENSe:] FILTer<n>:CCIT on page 149

SFM:

[SENSe:] SFM:<ChannelType>:FILTer:CCITt:STATe on page 237

CCIR Unweighted ← Weighting ← AF Filter ← AM

Switches on the CCIR unweighted filter, which is the combination of the 20 Hz high-pass and 23 kHz low pass filter. The weighting filter is active in the following demodulation bandwidth range:

$50 \text{ kHz} \leq \text{demodulation bandwidth} \leq 1.6 \text{ MHz}$

For FM stereo (K7S), the filter is active at all times, as the demodulation range is always 400 kHz.

Remote command:

[SENSe:] FILTer<n>:CCIR[:UNWeighted] [:STATe] on page 150

SFM:

[SENSe:] SFM:<ChannelType>:FILTer:CCIR[:UNWeighted] [:STATe]

on page 238

CCIR Weighted ← Weighting ← AF Filter ← AM

Switches on the CCIR weighted filter. The weighting filter is active in the following demodulation bandwidth range:

100 kHz ≤ demodulation bandwidth ≤ 3.0 MHz

For FM stereo (K7S), the filter is active at all times, as the demodulation range is always 400 kHz.

Remote command:

[SENSe:] FILTer<n>:CCIR:WEIGhted[:STATe] on page 150

SFM:

[SENSe:] SFM:<ChannelType>:FILTer:CCIR:WEIGhted[:STATe] on page 238

A Weighted ← Weighting ← AF Filter ← AM

Switches on the A weighted filter. The weighting filter is active in the following demodulation bandwidth range:

100 kHz ≤ demodulation bandwidth ≤ 800 kHz

Remote command:

[SENSe:] FILTer<n>:AWEIGhted[:STATe] on page 149

SFM:

[SENSe:] SFM:<ChannelType>:FILTer:AWEIGhted[:STATe] on page 237

Deemphasis ← AF Filter ← AM

Opens the "Deemphasis" selection list to switch on a deemphasis with the given time constant.

The deemphasis is active in the following demodulation bandwidth range:

Note: For FM stereo measurements (K7S), the demodulation bandwidth is always 400 kHz, thus the deemphasis is always active.

25 μs:	25 kHz ≤ demodulation bandwidth ≤ 40 MHz
50 μs:	6.4 kHz ≤ demodulation bandwidth ≤ 18 MHz
75 μs:	6.4 kHz ≤ demodulation bandwidth ≤ 18 MHz
750 μs:	800 Hz ≤ demodulation bandwidth ≤ 3 MHz

The following table shows the required demodulation bandwidth for an error less than 0.5 dB up to a maximum AF frequency.

deemphasis	25 μs	50 μs	75 μs	750 μs
max. AF frequency	25 kHz	12 kHz	8 kHz	800 Hz
required demodulation bandwidth	≥ 200 kHz	≥ 100 kHz	≥ 50 kHz	≥ 6.4 kHz

For higher AF frequencies the demodulation bandwidth must be increased.

Remote command:

[SENSe:]FILTer<n>:DEMPHasis[:STATe] on page 150

[SENSe:]FILTer<n>:DEMPHasis:TCONstant on page 151

SFM:

[SENSe:]SFM:<ChannelType>:FILTer:DEMPHasis:STATe on page 239

[SENSe:]SFM:<ChannelType>:FILTer:DEMPHasis:TCONstant on page 239

All AF Filter Off ← AF Filter ← AM

Disables all specified AF Filters.

Remote command:

[SENSe:]FILTer<n>:AOFF on page 148

AF Range ← AM

Opens a submenu to define the diagram scaling for AF displays.

Dev per Division ← AF Range ← AM

Opens an edit dialog box to set the modulation depth or the phase deviation (Analog Demodulation only), or frequency deviation per division:

AM display:	0.0001 % to 1000 %
FM display:	1 Hz/div to 100 MHz/div
PM display:	0.0001 rad/div to 1000 rad/div

The softkey is not available if logarithmic display is set ("Deviation Lin/Log" softkey).

Remote command:

DISPlay[:WINDow<n>]:TRACe<t>:Y[:SCALe]:PDIVision on page 112

Reference Position ← AF Range ← AM

Determines the position of the reference line for the modulation depth or the phase deviation (Analog Demodulation only) or frequency deviation on the y-axis of the diagram. By default, this line is set to 0.

The position is entered as a percentage of the diagram height with 100 % corresponding to the upper diagram border. The default setting is 50 % (diagram center) for the display of the AM, FM, or PM signal, and 100 % (upper diagram border) for the AF spectrum display of the AM, FM, or PM signal.

Remote command:

DISPlay[:WINDow<n>]:TRACe<t>:Y[:SCALe]:RPOSition on page 113

Reference Value ← AF Range ← AM

Determines the modulation depth or the phase deviation (Analog Demodulation only) or the frequency deviation at the reference line of the y-axis. The reference value is set separately for each display of the AM, FM, and PM signal and the AF spectrum of the AM, FM, and PM signal.

- AM/FM/PM signal display
The trace display takes individual frequency/phase offsets into account (in contrast, the [AF Coupling AC/DC](#) softkey permits automatic correction by the average fre-

quency/phase offset of the signal, and can therefore not be activated simultaneously).

Possible values: 0 and ± 10000 % (AM), 0 and ± 10 MHz (FM), 0 and ± 10000 rad (PM).

- AF spectrum display of the AM/FM/PM signal
In the default setting, the reference value defines the modulation depth or the FM/PM deviation at the upper diagram border.
Possible values: 0 and 10000 % (AM), 0 and 10 MHz (FM), 0 and 10000 rad (PM).

Remote command:

`DISPlay[:WINDow<n>]:TRACe<t>:Y[:SCALe]:RVALue` on page 114

AF Coupling AC/DC ← AF Range ← AM

Controls the automatic correction of the frequency offset and phase offset of the input signal:

(**Note:** This function is not available with the AF spectrum display of the FM or PM signal.)

- FM signal display
If DC is selected, the absolute frequency is displayed, i.e. an input signal with an offset relative to the center frequency is not displayed symmetrically with respect to the zero line.
If AC is selected, the frequency offset is automatically corrected, i.e. the trace is always symmetric with respect to the zero line.
- PM signal display
If DC is selected, the phase runs according to the existing frequency offset. In addition, the DC signal contains a phase offset of $\pm \pi$.
If AC is selected, the frequency offset and phase offset are automatically corrected, i.e. the trace is always symmetric with respect to the zero line.

Remote command:

`[SENSe:]ADEMod<n>:AF:COUPling` on page 122

Deviation Lin/Log ← AF Range ← AM

Switches between logarithmic and linear display of the modulation depth or the phase deviation (Analog Demodulation only) or the frequency deviation.

Remote command:

`DISPlay[:WINDow<n>]:TRACe<t>:Y:SPACing` on page 114

Unit ← AF Range ← AM

Opens a submenu to define the modulation unit.

Phase Unit (Rad/Deg) ← Unit ← AF Range ← AM

Sets the phase unit to rad or deg for displaying PM signals.

Remote command:

`UNIT:THD` on page 170

THD Unit (% / DB) ← Unit ← AF Range ← AM

Sets the unit to percent or DB for THD measurements.

Remote command:

[UNIT:THD](#) on page 170

Abs. Dev Unit (kHz/dBm) ← Unit ← AF Range ← AM

Sets the unit for absolute deviation to kHz or dBm. This softkey is only available with the FM Stereo option K7S.

Remote command:

[UNIT:ADEV](#) on page 249

Rel. Dev Unit (dB / %) ← Unit ← AF Range ← AM

Sets the unit for relative deviation to dB or percent. This softkey is only available with the FM Stereo option K7S.

Remote command:

[UNIT:RDEV](#) on page 250

Time Domain Zoom ← AM

Opens a submenu to activate and configure the zoom function.

State On / Off ← Time Domain Zoom ← AM

Activates or deactivates the time domain zoom according to the defined settings.

- | | |
|-------|---|
| "ON" | Activates the time domain zoom. The zoom area is defined using the "Start" "Start" on page 36 and "Length Manual" "Length Manual" on page 36 / "Length Auto" "Length Auto" on page 36 softkeys. |
| "OFF" | If more measured values than measurement points are available, several measured values are combined in one measurement point according to the method of the selected trace detector. For details on detectors refer to Chapter 2.1.8, "Detector Overview" , on page 19. |

Remote command:

[\[SENSe:\]ADEMod<n>:ZOOM\[:STATe\]](#) on page 143

Start ← Time Domain Zoom ← AM

Opens an edit dialog box to define the start time for the zoom area.

Remote command:

[\[SENSe:\]ADEMod<n>:ZOOM:START](#) on page 144

Length Manual ← Time Domain Zoom ← AM

Opens an edit dialog box to define the length of the zoom area (as a time value) manually.

Remote command:

[\[SENSe:\]ADEMod<n>:ZOOM:LENGTh](#) on page 144

Length Auto ← Time Domain Zoom ← AM

Automatically sets the length of the zoom area to the number of sweep points (see ["Sweep Points"](#) on page 57).

Remote command:

[\[SENSe:\]ADEMod<n>:ZOOM:LENGTh:MODE](#) on page 145

Squelch ← AM

Activates the squelch function, i.e. if the signal falls below a defined threshold, the demodulated data is automatically set to 0. This is useful, for example, to avoid demodulation noise during transmission breaks.

Remote command:

`[SENSe:]ADEMod:SQUelch[:STATe]` on page 142

Squelch Level ← AM

Defines the level threshold below which the demodulated data is set to 0 if squelching is enabled. The squelch level is an absolute value.

Remote command:

`[SENSe:]ADEMod:SQUelch:LEVel` on page 142

FM

Selects FM as the modulation type, changes the signal display, and opens a submenu to set the measurement configuration. The average value of the demodulated signal is mapped depending on the "AF Coupling" softkey setting (see "AF Coupling AC/DC" on page 35).

In single sweep mode, the data is determined from the current I/Q data set, i.e. a change to a different type does not trigger a new measurement.

This menu is also displayed when you press the [MEAS CONFIG] key after changing the modulation type.

Remote command:

`CALC:FEED 'XTIM:FM'` (see `CALCulate<n>:FEED` on page 90)

Display Config ← FM

See "Display Config" on page 28.

Select Trace ← FM

See "Select Trace" on page 30.

Demod BW ← FM

See "Demod BW" on page 30.

Meas Time ← FM

See "Meas Time" on page 31.

AF Filter ← FM

See "AF Filter" on page 31.

AF Range ← FM

See "AF Range" on page 34.

Time Domain Zoom ← FM

See "Time Domain Zoom" on page 36.

Squelch ← FM

See "Squelch" on page 37.

Squelch Level ← FM

See "Squelch Level" on page 37.

PM

Selects PM as the modulation type, changes the signal display, and opens a submenu to set the measurement configuration.

In single sweep mode, the data is determined from the current I/Q data set, i.e. a change to a different type does not trigger a new measurement.

This menu is also displayed when you press the [MEAS CONFIG] key after changing the modulation type.

Remote command:

`CALC:FEED 'XTIM:PM'` (see `CALCulate<n>:FEED` on page 90)

Display Config ← PM

See "Display Config" on page 28.

Select Trace ← PM

See "Select Trace" on page 30.

Demod BW ← PM

See "Demod BW" on page 30.

Meas Time ← PM

See "Meas Time" on page 31.

AF Filter ← PM

See "AF Filter" on page 31.

AF Range ← PM

See "AF Range" on page 34.

Time Domain Zoom ← PM

See "Time Domain Zoom" on page 36.

Squelch ← PM

See "Squelch" on page 37.

Squelch Level ← PM

See "Squelch Level" on page 37.

Zero Phase Reference Point ← PM

Defines the position at which the phase of the PM-demodulated signal is set to 0 rad. The entry is made with respect to time. In the default setting, the first measured value is set to 0 rad.

This softkey is only available in the PM display with DC coupling.

Remote command:

`[SENSe:]ADEMod:PM:RPOint[:X]` on page 137

Phase Wrap On/Off ← PM

Activates/deactivates the phase wrap.

On	The phase will be displayed in the range $\pm 180^\circ$ ($\pm \Pi$). For example, if the phase exceeds $+180^\circ$, 360° is subtracted from the phase value, with the display thus showing $>-180^\circ$.
Off	The phase will not be wrapped.

This softkey is available in the PM signal displays.

Remote command:

CALC:FORM PHAS (see [CALCulate<n>:FORMat](#) on page 93)

RF Power

Selects RF power as the modulation type, changes the signal display, and opens a submenu to set the measurement configuration.

In single sweep mode, the data is determined from the current I/Q data set, i.e. a change to a different type does not trigger a new measurement.

This menu is also displayed when you press the [MEAS CONFIG] key after changing the modulation type.

Remote command:

CALC:FEED 'XTIM:RFPower' (see [CALCulate<n>:FEED](#) on page 90)

Display Config ← RF Power

See "[Display Config](#)" on page 28.

Select Trace ← RF Power

See "[Select Trace](#)" on page 30.

Demod BW ← RF Power

See "[Demod BW](#)" on page 30.

Meas Time ← RF Power

See "[Meas Time](#)" on page 31.

AF Filter ← RF Power

See "[AF Filter](#)" on page 31.

AF Range ← RF Power

See "[AF Range](#)" on page 34.

Time Domain Zoom ← RF Power

See "[Time Domain Zoom](#)" on page 36.

Squelch ← RF Power

See "[Squelch](#)" on page 37.

Squelch Level ← RF Power

See "[Squelch Level](#)" on page 37.

Display Config

See "Display Config" on page 28.

2.2.2 Softkeys of the Frequency Menu – FREQ Key (Analog Demodulation)

The following table shows all softkeys available in the "Frequency" menu in "Analog Demodulation" mode ([FREQ] key). It is possible that your instrument configuration does not provide all softkeys. If a softkey is only available with a special option, model or (measurement) mode, this information is delivered in the corresponding softkey description.

Center.....	40
CF Stepsize.....	40
L 0.1*Span (RF Spectrum).....	40
L 0.1*Demod BW (AF/RF Time Domain, AF Spectrum).....	41
L 0.5*Span (RF Spectrum).....	41
L 0.5*Demod BW (AF/RF Time Domain, AF Spectrum).....	41
L x*Span (RF Spectrum).....	41
L x*Demod BW (AF/RF Time Domain, AF Spectrum).....	41
L =Center.....	41
L Manual.....	41
AF Center (AF Spectrum).....	42
AF Start.....	42
AF Stop.....	42

Center

Opens an edit dialog box to enter the center frequency. The allowed range of values for the center frequency depends on the frequency span.

$$\text{span} > 0: \text{span}_{\min}/2 \leq f_{\text{center}} \leq f_{\text{max}} - \text{span}_{\min}/2$$

$$\text{span} = 0: 0 \text{ Hz} \leq f_{\text{center}} \leq f_{\text{max}}$$

f_{max} and span_{\min} are specified in the data sheet.

If the bandwidth extension option R&S FSV-B160 is active, center frequencies above 7 GHz are not available.

Remote command:

[SENSe:] FREQuency:CENTer on page 153

CF Stepsize

Opens a submenu to set the step size of the center frequency. Apart from the =Center and Manual softkeys, the other softkeys are displayed depending on the selected frequency span.

The step size can be coupled to the span (span > 0) or the demodulation bandwidth (span = 0) or it can be manually set to a fixed value.

0.1*Span (RF Spectrum) ← CF Stepsize

Sets the step size for the center frequency to 10 % of the span.

Remote command:

[SENSe:] FREQuency:CENTer:STEP:LINK on page 154

[SENSe:] FREQuency:CENTer:STEP:LINK:FACTor on page 155

0.1*Demod BW (AF/RF Time Domain, AF Spectrum) ← CF Stepsize

Sets the step size for the center frequency to 10 % of the demodulation bandwidth. This is the default setting.

Remote command:

[SENSe:] FREQuency:CENTer:STEP:LINK on page 154

[SENSe:] FREQuency:CENTer:STEP:LINK:FACTor on page 155

0.5*Span (RF Spectrum) ← CF Stepsize

Sets the step size for the center frequency to 50 % of the span.

Remote command:

[SENSe:] FREQuency:CENTer:STEP:LINK on page 154

[SENSe:] FREQuency:CENTer:STEP:LINK:FACTor on page 155

0.5*Demod BW (AF/RF Time Domain, AF Spectrum) ← CF Stepsize

Sets the step size for the center frequency to 50 % of the demodulation bandwidth.

Remote command:

[SENSe:] FREQuency:CENTer:STEP:LINK on page 154

[SENSe:] FREQuency:CENTer:STEP:LINK:FACTor on page 155

x*Span (RF Spectrum) ← CF Stepsize

Opens an edit dialog box to set the step size for the center frequency as % of the span.

Remote command:

[SENSe:] FREQuency:CENTer:STEP:LINK on page 154

[SENSe:] FREQuency:CENTer:STEP:LINK:FACTor on page 155

x*Demod BW (AF/RF Time Domain, AF Spectrum) ← CF Stepsize

Opens an edit dialog box to set the step size for the center frequency as % of the demodulation bandwidth. Values between 1 and 100 % in steps of 1 % are allowed. The default setting is 10 %.

Remote command:

[SENSe:] FREQuency:CENTer:STEP:LINK on page 154

[SENSe:] FREQuency:CENTer:STEP:LINK:FACTor on page 155

=Center ← CF Stepsize

Sets the step size to the value of the center frequency and removes the coupling of the step size to span or resolution bandwidth.

This function is especially useful for measurements of the signal harmonics. In this case, each stroke of the arrow key selects the center frequency of another harmonic.

Manual ← CF Stepsize

Opens an edit dialog box to enter a fixed step size for the center frequency.

Remote command:

[SENSe:] FREQuency:CENTer:STEP on page 154

AF Center (AF Spectrum)

Opens an edit box to enter the center frequency within the AF spectrum.

Remote command:

[SENSe:]ADEMod<n>:AF:CENTer on page 121

AF Start

Opens an edit box to define the start frequency within the AF spectrum.

Remote command:

[SENSe:]ADEMod<n>:AF:START on page 123

AF Stop

Opens an edit box to define the stop frequency within the AF spectrum.

The maximum AF stop frequency corresponds to half the demodulation bandwidth.

Remote command:

[SENSe:]ADEMod<n>:AF:STOP on page 124

2.2.3 Softkeys of the Span Menu – SPAN Key (Analog Demodulation)

The following table shows all softkeys available in the "Span" menu in "Analog Demodulation" mode ([SPAN] key). It is possible that your instrument configuration does not provide all softkeys. If a softkey is only available with a special option, model or (measurement) mode, this information is delivered in the corresponding softkey description.

Span Manual (RF Spectrum).....	42
AF Span Manual (AF Spectrum).....	42
Demod BW.....	43
Full Span (RF Spectrum).....	43
AF Full Span (AF Spectrum).....	43

Span Manual (RF Spectrum)

Opens an edit dialog box to enter the frequency span. The center frequency is kept constant. If the RF spectrum display is active, values between the sampling rate/1000 and the demodulation bandwidth are allowed.

Remote command:

[SENSe:]ADEMod:SPECTrum:SPAN:ZOOM on page 142

AF Span Manual (AF Spectrum)

Opens an edit dialog box to enter the frequency range for the AF spectrum display. Values between the sampling rate/1000 and the demodulation bandwidth/2 are allowed.

Remote command:

[SENSe:]ADEMod<n>:AF:SPAN on page 122

Demod BW

Opens an edit dialog box to enter the demodulation bandwidth of the analog demodulation. The demodulation bandwidth determines the sampling rate for recording the signal to be analyzed. For details on the relation between demodulation bandwidth and sampling rate refer to [Chapter 2.1.3, "Sample Rate, Measurement Time and Trigger Offset"](#), on page 13.

Remote command:

[SENSe:]BANDwidth|BWIDth:DEMod on page 147

Full Span (RF Spectrum)

Sets the span to the maximum frequency range of the R&S FSVA/FSV specified in the data sheet. This setting is useful for overview measurements.

If the RF spectrum display is active, the full frequency range corresponds to the demodulation bandwidth.

Remote command:

[SENSe:]ADEMod:SPECTrum:SPAN:ZOOM on page 142

AF Full Span (AF Spectrum)

Sets the span to the maximum frequency range for the AF spectrum display. The maximum frequency range corresponds to half the demodulation bandwidth.

Remote command:

[SENSe:]ADEMod<n>:AF:SPAN:FULL on page 123

2.2.4 Softkeys of the Amplitude Menu – AMPT Key (Analog Demodulation)

The following table shows all softkeys available in the "Amplitude" menu in "Analog Demodulation" mode (AMPT key). It is possible that your instrument configuration does not provide all softkeys. If a softkey is only available with a special option, model or (measurement) mode, this information is delivered in the corresponding softkey description.

Ref Level.....	44
AF Range.....	44
Range.....	44
L Range Log 100 dB.....	44
L Range Log 50 dB.....	44
L Range Log 10 dB.....	45
L Range Log 5 dB.....	45
L Range Log 1 dB.....	45
L Range Log Manual.....	45
L Range Linear %.....	45
L Range Lin. Unit.....	46
Unit.....	46
L Phase Unit (Rad/Deg).....	46
L THD Unit (% / DB).....	46
Preamp On/Off.....	46
RF Atten Manual/Mech Att Manual.....	46

RF Atten Auto/Mech Att Auto.....	47
EI Atten On/Off.....	47
EI Atten Mode (Auto/Man).....	47
Ref Level Offset.....	48
Ref Level Position.....	48
Grid Abs/Rel	48
Input (AC/DC).....	48
Input 50 Ω/75 Ω	49

Ref Level

Opens an edit dialog box to enter the reference level in the current unit (dBm, dBμV, etc).

The reference level is the maximum value the AD converter can handle without distortion of the measured value. Signal levels above this value will not be measured correctly, which is indicated by the "IFOVL" status display.

Remote command:

`DISPlay[:WINDow<n>]:TRACe<t>:Y[:SCALe]:RLEVel` on page 113

AF Range

Only available for AM/FM/PM measurements (see [Chapter 2.1.10, "Measurement Result Display"](#), on page 20).

For details refer to the "AF Range" softkey of the main menu (see ["AF Range"](#) on page 34).

Range

Only available for RF measurements (see [Chapter 2.1.10, "Measurement Result Display"](#), on page 20).

Opens a submenu to define the level display range.

Range Log 100 dB ← Range

Sets the level display range to 100 dB.

Remote command:

Logarithmic scaling:

`DISP:WIND:TRAC:Y:SPAC LOG`, see `DISPlay[:WINDow<n>]:TRACe<t>:Y:SPACing` on page 114

Display range:

`DISP:WIND:TRAC:Y 100DB`, see `DISPlay[:WINDow<n>]:TRACe<t>:Y[:SCALe]` on page 111

Range Log 50 dB ← Range

Sets the level display range to 50 dB.

Remote command:

Logarithmic scaling:

`DISP:WIND:TRAC:Y:SPAC LOG`, see `DISPlay[:WINDow<n>]:TRACe<t>:Y:SPACing` on page 114

Display range:

`DISP:WIND:TRAC:Y 50DB`, see `DISPlay[:WINDow<n>]:TRACe<t>:Y[:SCALe]` on page 111

Range Log 10 dB ← Range

Sets the level display range to 10 dB.

Remote command:

Logarithmic scaling:

DISP:WIND:TRAC:Y:SPAC LOG, see [DISPlay\[:WINDow<n>\]:TRACe<t>:Y:SPACing](#) on page 114

Display range:

DISP:WIND:TRAC:Y 10DB, see [DISPlay\[:WINDow<n>\]:TRACe<t>:Y\[:SCALe\]](#) on page 111

Range Log 5 dB ← Range

Sets the level display range to 5 dB.

Remote command:

Logarithmic scaling:

DISP:WIND:TRAC:Y:SPAC LOG, see [DISPlay\[:WINDow<n>\]:TRACe<t>:Y:SPACing](#) on page 114

Display range:

DISP:WIND:TRAC:Y 5DB, see [DISPlay\[:WINDow<n>\]:TRACe<t>:Y\[:SCALe\]](#) on page 111

Range Log 1 dB ← Range

Sets the level display range to 1 dB.

Remote command:

Logarithmic scaling:

DISP:WIND:TRAC:Y:SPAC LOG, see [DISPlay\[:WINDow<n>\]:TRACe<t>:Y:SPACing](#) on page 114

Display range:

DISP:WIND:TRAC:Y 1DB, see [DISPlay\[:WINDow<n>\]:TRACe<t>:Y\[:SCALe\]](#) on page 111

Range Log Manual ← Range

Opens an edit dialog box to define the display range of a logarithmic level axis manually.

Remote command:

Logarithmic scaling:

DISP:WIND:TRAC:Y:SPAC LOG, see [DISPlay\[:WINDow<n>\]:TRACe<t>:Y:SPACing](#) on page 114

Display range:

[DISPlay\[:WINDow<n>\]:TRACe<t>:Y\[:SCALe\]](#) on page 111

Range Linear % ← Range

Selects linear scaling for the level axis in %.

The grid is divided into decadal sections.

Markers are displayed in the selected unit ("Unit" softkey). Delta markers are displayed in % referenced to the voltage value at the position of marker 1. This is the default setting for linear scaling.

Remote command:

DISP:TRAC:Y:SPAC LIN, see [DISPlay\[:WINDow<n>\]:TRACe<t>:Y:SPACing](#) on page 114

Range Lin. Unit ← Range

Selects linear scaling in dB for the level display range, i.e. the horizontal lines are labeled in dB.

Markers are displayed in the selected unit ("Unit" softkey). Delta markers are displayed in dB referenced to the power value at the position of marker 1.

Remote command:

DISP:TRAC:Y:SPAC LDB, see [DISPlay\[:WINDow<n>\]:TRACe<t>:Y:SPACing](#) on page 114

Unit

Opens a submenu to define the unit of the measurement results.

Phase Unit (Rad/Deg) ← Unit

Sets the phase unit to rad or deg for displaying PM signals.

Remote command:

[UNIT:THD](#) on page 170

THD Unit (% / DB) ← Unit

Sets the unit to percent or DB for THD measurements.

Remote command:

[UNIT:THD](#) on page 170

Preamp On/Off

Switches the preamplifier on and off.

If option R&S FSV-B22 is installed, the preamplifier is only active below 7 GHz.

If option R&S FSV-B24 is installed, the preamplifier is active for all frequencies.

This function is not available for input from the R&S Digital I/Q Interface (option R&S FSV-B17).

Remote command:

[INPut:GAIN:STATe](#) on page 181

RF Atten Manual/Mech Att Manual

Opens an edit dialog box to enter the attenuation, irrespective of the reference level. If electronic attenuation is activated (option R&S FSV-B25 only; "El Atten Mode Auto" softkey), this setting defines the mechanical attenuation.

The mechanical attenuation can be set in 10 dB steps.

The RF attenuation can be set in 5 dB steps (R&S FSV with option R&S FSV-B25 or R&S FSVA: 1 dB steps). The range is specified in the data sheet. If the current reference level cannot be set for the set RF attenuation, the reference level is adjusted accordingly.

This function is not available for input from the R&S Digital I/Q Interface (option R&S FSV-B17).

The RF attenuation defines the level at the input mixer according to the formula:

$$\text{level}_{\text{mixer}} = \text{level}_{\text{input}} - \text{RF attenuation}$$

Note: As of firmware version 1.61, the maximum mixer level allowed is **0 dBm**. Mixer levels above this value may lead to incorrect measurement results, which are indicated by the "OVL" status display. The increased mixer level allows for an improved signal, but also increases the risk of overloading the instrument!

Remote command:

[INPut:ATTenuation](#) on page 177

RF Atten Auto/Mech Att Auto

Sets the RF attenuation automatically as a function of the selected reference level. This ensures that the optimum RF attenuation is always used. It is the default setting.

This function is not available for input from the R&S Digital I/Q Interface (option R&S FSV-B17).

Remote command:

[INPut:ATTenuation:AUTO](#) on page 177

EI Atten On/Off

This softkey switches the electronic attenuator on or off. This softkey is only available with option R&S FSV-B25.

When the electronic attenuator is activated, the mechanical and electronic attenuation can be defined separately. Note however, that both parts must be defined in the same mode, i.e. either both manually, or both automatically.

This function is not available for input from the R&S Digital I/Q Interface (option R&S FSV-B17).

- To define the mechanical attenuation, use the [RF Atten Manual/Mech Att Manual](#) or [RF Atten Auto/Mech Att Auto](#) softkeys.
- To define the electronic attenuation, use the [EI Atten Mode \(Auto/Man\)](#) softkey.

Note: This function is not available for stop frequencies (or center frequencies in zero span) >7 GHz. In this case, the electronic and mechanical attenuation are summarized and the electronic attenuation can no longer be defined individually. As soon as the stop or center frequency is reduced below 7 GHz, this function is available again. When the electronic attenuator is switched off, the corresponding RF attenuation mode (auto/manual) is automatically activated.

Remote command:

[INPut:EATT:AUTO](#) on page 181

EI Atten Mode (Auto/Man)

This softkey defines whether the electronic attenuator value is to be set automatically or manually. If manual mode is selected, an edit dialog box is opened to enter the value. This softkey is only available with option R&S FSV-B25, and only if the electronic attenuator has been activated via the [EI Atten On/Off](#) softkey.

Note: This function is not available for stop frequencies (or center frequencies in zero span) >7 GHz. In this case, the electronic and mechanical attenuation are summarized and the electronic attenuation can no longer be defined individually. As soon as the

stop or center frequency is reduced below 7 GHz, electronic attenuation is available again. If the electronic attenuation was defined manually, it must be re-defined.

The attenuation can be varied in 1 dB steps from 0 to 30 dB. Other entries are rounded to the next lower integer value.

To re-open the edit dialog box for manual value definition, select the "Man" mode again.

If the defined reference level cannot be set for the given RF attenuation, the reference level is adjusted accordingly and the warning "Limit reached" is output.

Remote command:

`INPut:EATT:AUTO` on page 181

`INPut:EATT` on page 181

Ref Level Offset

Opens an edit dialog box to enter the arithmetic level offset. This offset is added to the measured level irrespective of the selected unit. The scaling of the y-axis is changed accordingly. The setting range is ± 200 dB in 0.1 dB steps.

Remote command:

`DISPlay[:WINDow<n>]:TRACe<t>:Y[:SCALe]:RLEVel:OFFSet` on page 113

Ref Level Position

Opens an edit dialog box to enter the reference level position, i.e. the position of the maximum AD converter value on the level axis. The setting range is from -200 to +200 %, 0 % corresponding to the lower and 100 % to the upper limit of the diagram.

Only available for RF measurements.

Remote command:

`DISPlay[:WINDow<n>]:TRACe<t>:Y[:SCALe]:RPOSition` on page 113

Grid Abs/Rel

Switches between absolute and relative scaling of the level axis (not available with "Linear" range).

Only available for RF measurements.

"Abs" Absolute scaling: The labeling of the level lines refers to the absolute value of the reference level. Absolute scaling is the default setting.

"Rel" Relative scaling: The upper line of the grid is always at 0 dB. The scaling is in dB whereas the reference level is always in the set unit (for details on unit settings see the "Unit" softkey).

Remote command:

`DISPlay[:WINDow<n>]:TRACe<t>:Y[:SCALe]:MODE` on page 112

Input (AC/DC)

Toggles the RF input of the R&S FSVA/FSV between AC and DC coupling.

This function is not available for input from the R&S Digital I/Q Interface (option R&S FSV-B17).

Remote command:

`INPut:COUPling` on page 178

Input 50 Ω/75 Ω

Uses 50 Ω or 75 Ω as reference impedance for the measured levels. Default setting is 50 Ω.

The setting 75 Ω should be selected if the 50 Ω input impedance is transformed to a higher impedance using a 75 Ω adapter of the RAZ type (= 25 Ω in series to the input impedance of the instrument). The correction value in this case is 1.76 dB = 10 log (75 Ω/50 Ω).

All levels specified in this Operating Manual refer to the default setting of the instrument (50 Ω).

This function is not available for input from the R&S Digital I/Q Interface (option R&S FSV-B17).

Remote command:

`INPut : IMPedance` on page 182

2.2.5 Softkeys of the Auto Set menu - AUTO SET Key (Analog Demodulation)

The following table shows all softkeys available in the "Auto Set" menu. It is possible that your instrument configuration does not provide all softkeys. If a softkey is only available with a special option, model or (measurement) mode, this information is provided in the corresponding softkey description.



Adjusting settings automatically during triggered measurements

When you select an auto adjust function a measurement is performed to determine the optimal settings. If you select an auto adjust function for a triggered measurement, you can select how the R&S FSVA/FSV should behave:

- (default:) The measurement for adjustment waits for the next trigger
- The measurement for adjustment is performed without waiting for a trigger. The trigger source is temporarily set to "Free Run". After the measurement is completed, the original trigger source is restored. The trigger level for IF Power and RF Power triggers is adjusted as follows:
Trigger Level = Reference Level - 15 dB

Auto All.....	49
Auto Freq.....	50
Auto Level.....	50
Settings.....	50
L Meas Time Manual.....	50
L Meas Time Auto.....	50
L Upper Level Hysteresis.....	50
L Lower Level Hysteresis.....	51
AF Auto Scale.....	51

Auto All

Performs all automatic settings.

- "Auto Freq" on page 50
- "Auto Level" on page 50

Remote command:

[SENSe:]ADJust:ALL on page 145

Auto Freq

Defines the center frequency and the reference level automatically by determining the highest frequency level in the frequency span. This function uses the signal counter; thus it is intended for use with sinusoidal signals.

This function is not available for input from the R&S Digital I/Q Interface (option R&S FSV-B17).

Remote command:

[SENSe:]ADJust:FREQuency on page 146

Auto Level

Defines the optimal reference level for the current measurement automatically.

The measurement time for automatic leveling can be defined using the [Settings](#) softkey.

Remote command:

[SENSe:]ADJust:LEVel on page 147

Settings

Opens a submenu to define settings for automatic leveling.

Possible settings are:

- "Meas Time Manual" on page 50
- "Meas Time Auto" on page 50

Meas Time Manual ← Settings

Opens an edit dialog box to enter the duration of the level measurement in seconds. The level measurement is used to determine the optimal reference level automatically (see the "Auto Level" softkey, "Auto Level" on page 50). The default value is 1 ms.

Remote command:

[SENSe:]ADJust:CONFigure:LEVel:DURation on page 146

Meas Time Auto ← Settings

The level measurement is used to determine the optimal reference level automatically (see the [Auto Level](#) softkey).

This softkey resets the level measurement duration for automatic leveling to the default value of 100 ms.

Upper Level Hysteresis ← Settings

Defines an upper threshold the signal must exceed before the reference level is automatically adjusted when the "Auto Level" function is performed.

Remote command:

[SENSe:]ADJust:CONFigure:HYSTeresis:UPPer on page 146

Lower Level Hysteresis ← Settings

Defines a lower threshold the signal must exceed before the reference level is automatically adjusted when the "Auto Level" function is performed.

Remote command:

[SENSe:]ADJust:CONFIguration:HYSTeresis:LOWer on page 145

AF Auto Scale

Activates automatic scaling of the y-axis for AF measurements. RF power and RF spectrum measurements are not affected by the auto-scaling.

Remote command:

[SENSe:]ADJust:SCALE:Y:AUTO[:CONTInuous] on page 147

2.2.6 Softkeys of the Bandwidth Menu – BW Key (Analog Demodulation)

The following table shows all softkeys available in the "Bandwidth" menu in "Analog Demodulation" mode (BW key). It is possible that your instrument configuration does not provide all softkeys. If a softkey is only available with a special option, model or (measurement) mode, this information is delivered in the corresponding softkey description.

Res BW (span > 0).....	51
Demod BW.....	52
Meas Time.....	52
AF Filter.....	52
L High Pass.....	52
L Low Pass.....	52
L Weighting.....	53
L None.....	53
L CCITT.....	53
L CCIR Unweighted.....	54
L CCIR Weighted.....	54
L A Weighted.....	54
L Deemphasis.....	54
L All AF Filter Off.....	55
Demod Filter.....	55

Res BW (span > 0)

Opens an edit dialog box to enter a value for the resolution bandwidth. The range is specified in the data sheet.

This softkey is only available for spectrum measurements (see [Chapter 2.1.10, "Measurement Result Display"](#), on page 20).

Remote command:

[SENSe:]ADEMod:SPECTrum:BANDwidth|BWIDth[:RESolution] on page 140

Demod BW

Opens an edit dialog box to enter the demodulation bandwidth of the analog demodulation. The demodulation bandwidth determines the sampling rate for recording the signal to be analyzed. For details on the relation between demodulation bandwidth and sampling rate refer to [Chapter 2.1.3, "Sample Rate, Measurement Time and Trigger Offset"](#), on page 13.

Remote command:

[SENSe:]BANDwidth|BWIDth:DEMod on page 147

Meas Time

Opens an editor for entering the measurement time of the analog demodulation. For details on the measurement time values refer to [Chapter 2.1.3, "Sample Rate, Measurement Time and Trigger Offset"](#), on page 13.

Note: For FM Stereo measurements (option K7S), the minimum measurement time is 2 ms.

Remote command:

[SENSe:]ADEMod:MTIME on page 133

AF Filter

The bandwidth of the demodulated signal can be reduced by high pass or low pass filters and also a de-emphasis can be switched on. The selected filters are used for AM, FM and PM demodulation in common. Individual settings are not possible.

High Pass ← AF Filter

Opens the "High Pass" selection list to switch on a high pass filter with the given limit to separate the DC component. The filters are indicated by the 3 dB cutoff frequency. The 50 Hz and 300 Hz filters are designed as 2nd-order Butterworth filter (12 dB/octave). The 20 Hz filter is designed as 3rd-order Butterworth filter (18 dB/octave).

"None" deactivates the AF high pass filter. Default is "None".

The high pass filters are active in the following demodulation bandwidth range:

20 Hz	100 Hz ≤ demodulation bandwidth ≤ 1.6 MHz
50 Hz:	200 Hz ≤ demodulation bandwidth ≤ 3 MHz
300 Hz:	800 Hz ≤ demodulation bandwidth ≤ 8 MHz
Note: for FM stereo (K7S), all filters are active at all times, as the demodulation range is always 400 kHz	

Remote command:

[SENSe:]FILTer<n>:HPASs[:STATe] on page 151

[SENSe:]FILTer<n>:HPASs:FREQuency on page 152

Low Pass ← AF Filter

Opens the "Low Pass" selection list to select the filter type. Relative and absolute low pass filter are available.

- Absolute low pass filters:
The 3 kHz, 15 kHz; 23 kHz and 150 kHz softkeys switch on a absolute low pass filter. The filters are indicated by the 3 dB cutoff frequency. The 3 kHz, 15 kHz and

23 kHz filters are designed as 5th-order Butterworth filters (30 dB/octave). The 150 kHz filter is designed as 8th-order Butterworth filter (48 dB/octave).

The absolute low pass filters are active in the following demodulation bandwidth range:

3 kHz:	6.4 kHz ≤ demodulation bandwidth ≤ 3 MHz
15 kHz:	50 kHz ≤ demodulation bandwidth ≤ 8 MHz
23 kHz:	50 kHz ≤ demodulation bandwidth ≤ 18 MHz
150 kHz:	400 kHz ≤ demodulation bandwidth ≤ 8 MHz
Note: for FM stereo (K7S), all filters are active at all times, as the demodulation range is always 400 kHz	

- Relative low pass filters:
The filters (3 dB) can be selected in % of the demodulation bandwidth. The filters are designed as 5th-order Butterworth filter (30 dB/octave) and active for all demodulation bandwidths.
- "None" deactivates the AF low pass filter. Default is "None".

Remote command:

[\[SENSe:\] FILTER<n>:LPASs\[:STATe\]](#) on page 152

[\[SENSe:\] FILTER<n>:LPASs:FREQuency\[:ABSolute\]](#) on page 152

[\[SENSe:\] FILTER<n>:LPASs:FREQuency:RELative](#) on page 153

SFM:

[\[SENSe:\] SFM:<ChannelType>:FILTer:LPASs:STATe](#) on page 240

[\[SENSe:\] SFM:<ChannelType>:FILTer:LPASs:FREQuency](#) on page 241

Weighting ← AF Filter

Opens the "Weighting" selection list to select the weighting AF filter.

None ← Weighting ← AF Filter

Deactivates the weighting filter. This is the default setting.

Remote command:

[\[SENSe:\] FILTER<n>:HPASs\[:STATe\]](#) on page 151

CCITT ← Weighting ← AF Filter

Switches on a CCITT P.53 weighting filter. The weighting filter is active in the following demodulation bandwidth range:

20 kHz ≤ demodulation bandwidth ≤ 3 MHz

For FM stereo (K7S), the filter is active at all times, as the demodulation range is always 400 kHz.

Remote command:

[\[SENSe:\] FILTER<n>:CCIT](#) on page 149

SFM:

[\[SENSe:\] SFM:<ChannelType>:FILTer:CCITt:STATe](#) on page 237

CCIR Unweighted ← Weighting ← AF Filter

Switches on the CCIR unweighted filter, which is the combination of the 20 Hz high-pass and 23 kHz low pass filter. The weighting filter is active in the following demodulation bandwidth range:

50 kHz \leq demodulation bandwidth \leq 1.6 MHz

For FM stereo (K7S), the filter is active at all times, as the demodulation range is always 400 kHz.

Remote command:

[SENSe:]FILTer<n>:CCIR[:UNWeighted] [:STATe] on page 150

SFM:

[SENSe:]SFM:<ChannelType>:FILTer:CCIR[:UNWeighted] [:STATe]

on page 238

CCIR Weighted ← Weighting ← AF Filter

Switches on the CCIR weighted filter. The weighting filter is active in the following demodulation bandwidth range:

100 kHz \leq demodulation bandwidth \leq 3.0 MHz

For FM stereo (K7S), the filter is active at all times, as the demodulation range is always 400 kHz.

Remote command:

[SENSe:]FILTer<n>:CCIR:WEIGhted [:STATe] on page 150

SFM:

[SENSe:]SFM:<ChannelType>:FILTer:CCIR:WEIGhted [:STATe] on page 238

A Weighted ← Weighting ← AF Filter

Switches on the A weighted filter. The weighting filter is active in the following demodulation bandwidth range:

100 kHz \leq demodulation bandwidth \leq 800 kHz

Remote command:

[SENSe:]FILTer<n>:AWEIGhted [:STATe] on page 149

SFM:

[SENSe:]SFM:<ChannelType>:FILTer:AWEIGhted [:STATe] on page 237

Deemphasis ← AF Filter

Opens the "Deemphasis" selection list to switch on a deemphasis with the given time constant.

The deemphasis is active in the following demodulation bandwidth range:

Note: For FM stereo measurements (K7S), the demodulation bandwidth is always 400 kHz, thus the deemphasis is always active.

25 μ s:	25 kHz \leq demodulation bandwidth \leq 40 MHz
50 μ s:	6.4 kHz \leq demodulation bandwidth \leq 18 MHz
75 μ s:	6.4 kHz \leq demodulation bandwidth \leq 18 MHz
750 μ s:	800 Hz \leq demodulation bandwidth \leq 3 MHz

The following table shows the required demodulation bandwidth for an error less than 0.5 dB up to a maximum AF frequency.

deemphasis	25 μ s	50 μ s	75 μ s	750 μ s
max. AF frequency	25 kHz	12 kHz	8 kHz	800 Hz
required demodulation bandwidth	\geq 200 kHz	\geq 100 kHz	\geq 50 kHz	\geq 6.4 kHz

For higher AF frequencies the demodulation bandwidth must be increased.

Remote command:

[SENSe:] FILTer<n>:DEMPHasis[:STATe] on page 150

[SENSe:] FILTer<n>:DEMPHasis:TCONstant on page 151

SFM:

[SENSe:] SFM:<ChannelType>:FILTer:DEMPHasis:STATe on page 239

[SENSe:] SFM:<ChannelType>:FILTer:DEMPHasis:TCONstant on page 239

All AF Filter Off ← AF Filter

Disables all specified AF Filters.

Remote command:

[SENSe:] FILTer<n>:AOFF on page 148

Demod Filter

By default, a flat demodulation filter is used in Analog Demodulation mode. However, in order to optimize the settling behaviour of the filter, a Gaussian filter can be used instead.

For details on sample rates, measurement times and trigger offsets for various demodulation bandwidths when using a Gaussian filter, see [Chapter 2.1.3, "Sample Rate, Measurement Time and Trigger Offset"](#), on page 13.

Remote command:

[SENSe:] BANDwidth:DEMod:TYPE on page 148

2.2.7 Softkeys of the Sweep Menu – SWEEP Key (Analog Demodulation)

The following table shows all softkeys available in the "Sweep" menu in "Analog Demodulation" mode ([SWEEP] key). It is possible that your instrument configuration does not provide all softkeys. If a softkey is only available with a special option, model or (measurement) mode, this information is delivered in the corresponding softkey description.

Continuous Sweep.....	56
Single Sweep.....	56
Continue Single Sweep.....	56
Meas Time.....	56
Sweep Count.....	56
Sweep Points.....	57
Capture Mode.....	57
Capture Time.....	57
Demod Offset.....	57

Continuous Sweep

Sets the continuous sweep mode: the sweep takes place continuously according to the trigger settings. This is the default setting.

The trace averaging is determined by the sweep count value (see the "Sweep Count" softkey, "[Sweep Count](#)" on page 56).

Remote command:

INIT:CONT ON, see [INITiate<n>:CONTinuous](#) on page 186

Single Sweep

Sets the single sweep mode: after triggering, starts the number of sweeps that are defined by using the [Sweep Count](#) softkey. The measurement stops after the defined number of sweeps has been performed.

Remote command:

INIT:CONT OFF, see [INITiate<n>:CONTinuous](#) on page 186

Continue Single Sweep

Repeats the number of sweeps set by using the [Sweep Count](#) softkey, without deleting the trace of the last measurement.

This is particularly of interest when using the trace configurations "Average" or "Max Hold" to take previously recorded measurements into account for averaging/maximum search.

Remote command:

[INITiate<n>:CONMeas](#) on page 185

Meas Time

Opens an editor for entering the measurement time of the analog demodulation. For details on the measurement time values refer to [Chapter 2.1.3, "Sample Rate, Measurement Time and Trigger Offset"](#), on page 13.

Note: For FM Stereo measurements (option K7S), the minimum measurement time is 2 ms.

Remote command:

[\[SENSe:\]ADEMod:MTIME](#) on page 133

Sweep Count

Opens an edit dialog box to enter the number of sweeps to be performed in the single sweep mode. Values from 0 to 32767 are allowed. If the values 0 or 1 are set, one sweep is performed. The sweep count is applied to all the traces in a diagram.

If the trace configurations "Average", "Max Hold" or "Min Hold" are set, the sweep count value also determines the number of averaging or maximum search procedures.

In continuous sweep mode, if sweep count = 0 (default), averaging is performed over 10 sweeps. For sweep count = 1, no averaging, maxhold or minhold operations are performed.

Remote command:

[\[SENSe:\]SWEep:COUNT](#) on page 155

Sweep Points

Opens an edit dialog box to enter the number of measured values to be collected during one sweep.

- Entry via rotary knob:
 - In the range from 101 to 1001, the sweep points are increased or decreased in steps of 100 points.
 - In the range from 1001 to 32001, the sweep points are increased or decreased in steps of 1000 points.
- Entry via keypad:
 - All values in the defined range can be set.

The default value is 691 sweep points.

Remote command:

[SENSe:] SWEEp: POINTs on page 157

Capture Mode

This command defines how the size of the the capture buffer is defined for analog demodulation.

In Auto mode, the size of the capture buffer is identical to the defined [Meas Time](#).

In Manual mode, the size of the capture buffer can be defined manually ([Capture Time](#)).

Remote command:

[SENSe:] ADEMod: CAPTure [:MODE] on page 121

Capture Time

Defines the size of the capture buffer for analog demodulation if [Capture Mode](#) is set to "Manual".

The maximum capture buffer size is 7.5 MSamples; the capture time depends on the defined DBW. For a DBW of 25 kHz, for example, the maximum capture time is 240 s.

Remote command:

[SENSe:] ADEMod: CAPTure: TIME on page 120

Demod Offset

This command defines an offset of the defined measurement time from the beginning of the capture buffer for analog demodulation if [Capture Mode](#) is set to "Manual". All results are recalculated automatically based on the new data.

Remote command:

[SENSe:] ADEMod: CAPTure: DOFFset on page 120

2.2.8 Softkeys of the Trace Menu – TRACE key (Analog Demodulation)

The [TRACE] key is used to configure the data acquisition for measurement and the analysis of the measurement data.

Trace 1/Trace 2/Trace 3/Trace 4/Trace 5/Trace 6

Selects the active trace (1, 2, 3, 4, 5, 6) and opens the "Trace Mode" submenu for the selected trace.

The default setting is trace 1 in the overwrite mode (see "Clear Write" on page 17), the other traces are switched off (see "Blank" on page 19). For details see [Chapter 2.1.7, "Trace Mode Overview"](#), on page 17.

Tip: To configure several traces in one step, press the [Trace Wizard](#) softkey to open a trace configuration dialog. See also [Chapter 2.1.6, "Configuring Traces"](#), on page 16.

Remote command:

Selected via numeric suffix of: TRACe<1 . . . 6> commands

Clear Write ← Trace 1/Trace 2/Trace 3/Trace 4/Trace 5/Trace 6

Overwrite mode: the trace is overwritten by each sweep. This is the default setting.

All available detectors can be selected.

Remote command:

DISP:TRAC:MODE WRIT, see [DISPlay\[:WINDow<n>\]:TRACe<t>:MODE](#) on page 110

Max Hold ← Trace 1/Trace 2/Trace 3/Trace 4/Trace 5/Trace 6

The maximum value is determined over several sweeps and displayed. The R&S FSVA/FSV saves the sweep result in the trace memory only if the new value is greater than the previous one.

The detector is automatically set to "Positive Peak".

This mode is especially useful with modulated or pulsed signals. The signal spectrum is filled up upon each sweep until all signal components are detected in a kind of envelope.

This mode is not available for statistics measurements.

Remote command:

DISP:TRAC:MODE MAXH, see [DISPlay\[:WINDow<n>\]:TRACe<t>:MODE](#) on page 110

Min Hold ← Trace 1/Trace 2/Trace 3/Trace 4/Trace 5/Trace 6

The minimum value is determined from several measurements and displayed. The R&S FSVA/FSV saves the smallest of the previously stored/currently measured values in the trace memory.

The detector is automatically set to "Negative Peak".

This mode is useful e.g. for making an unmodulated carrier in a composite signal visible. Noise, interference signals or modulated signals are suppressed whereas a CW signal is recognized by its constant level.

This mode is not available for statistics measurements.

Remote command:

DISP:TRAC:MODE MINH, see [DISPlay\[:WINDow<n>\]:TRACe<t>:MODE](#) on page 110

Average ← Trace 1/Trace 2/Trace 3/Trace 4/Trace 5/Trace 6

The average is formed over several sweeps. The [Sweep Count](#) determines the number of averaging procedures.

All available detectors can be selected. If the detector is automatically selected, the sample detector is used (see [Chapter 2.1.8, "Detector Overview"](#), on page 19).

This mode is not available for statistics measurements.

Remote command:

DISP:TRAC:MODE AVER, see [DISPlay\[:WINDow<n>\]:TRACe<t>:MODE](#) on page 110

View ← Trace 1/Trace 2/Trace 3/Trace 4/Trace 5/Trace 6

The current contents of the trace memory are frozen and displayed.

Note: If a trace is frozen, the instrument settings, apart from level range and reference level (see below), can be changed without impact on the displayed trace. The fact that the displayed trace no longer matches the current instrument setting is indicated by the  icon on the tab label.

If the level range or reference level is changed, the R&S FSVA/FSV automatically adapts the measured data to the changed display range. This allows an amplitude zoom to be made after the measurement in order to show details of the trace.

Remote command:

DISP:TRAC:MODE VIEW, see [DISPlay\[:WINDow<n>\]:TRACe<t>:MODE](#) on page 110

Blank ← Trace 1/Trace 2/Trace 3/Trace 4/Trace 5/Trace 6

Hides the selected trace.

Remote command:

DISP:TRAC OFF, see [DISPlay\[:WINDow<n>\]:TRACe<t>\[:STATe\]](#) on page 111

Detector ← Trace 1/Trace 2/Trace 3/Trace 4/Trace 5/Trace 6

Opens a submenu to select the detector manually, or activate automatic selection.

If a detector was selected manually, the "MAN" indicator is highlighted.

If "AUTO" is selected, the detector is defined automatically, depending on the selected trace mode:

Trace mode	Detector
Clear Write	Auto Peak
Max Hold	Positive Peak
Min Hold	Negative Peak
Average	Sample Peak
View	–
Blank	–

For details see [Chapter 2.1.8, "Detector Overview"](#), on page 19.

Note: In Analog Demod mode, if AUTO is selected, the Auto Peak detector is used regardless of the trace mode. However, if Noise or Phase Noise measurements are performed in Analog Demod mode, the Sample Detector is used.

Auto Select ← Detector ← Trace 1/Trace 2/Trace 3/Trace 4/Trace 5/Trace 6

Selects the best detector for the selected trace and filter mode. This is the default setting.

For details see also [Chapter 2.1.8, "Detector Overview"](#), on page 19.

Trace mode	Detector
Clear/Write	Auto Peak
Average	Sample
Max Hold	Max Peak
Min Hold	Min Peak

Remote command:

[SENSe:] [WINDow:] DETector<trace> [:FUNCTION] :AUTO on page 159

Auto Peak ← Detector ← Trace 1/Trace 2/Trace 3/Trace 4/Trace 5/Trace 6

Selects the "Auto Peak" detector.

For details see [Chapter 2.1.8, "Detector Overview"](#), on page 19.

Remote command:

DET APE, see [SENSe:] [WINDow:] DETector<trace> [:FUNCTION] on page 159

Positive Peak ← Detector ← Trace 1/Trace 2/Trace 3/Trace 4/Trace 5/Trace 6

Selects the "Positive Peak" detector.

For details see [Chapter 2.1.8, "Detector Overview"](#), on page 19.

Remote command:

DET POS, see [SENSe:] [WINDow:] DETector<trace> [:FUNCTION] on page 159

Negative Peak ← Detector ← Trace 1/Trace 2/Trace 3/Trace 4/Trace 5/Trace 6

Selects the "Negative Peak" detector.

For details see [Chapter 2.1.8, "Detector Overview"](#), on page 19.

Remote command:

DET NEG, see [SENSe:] [WINDow:] DETector<trace> [:FUNCTION] on page 159

Sample ← Detector ← Trace 1/Trace 2/Trace 3/Trace 4/Trace 5/Trace 6

Selects the "Sample" detector.

For details see [Chapter 2.1.8, "Detector Overview"](#), on page 19.

Remote command:

DET SAMP, see [SENSe:] [WINDow:] DETector<trace> [:FUNCTION] on page 159

RMS ← Detector ← Trace 1/Trace 2/Trace 3/Trace 4/Trace 5/Trace 6

Selects the "RMS" detector.

For details see [Chapter 2.1.8, "Detector Overview"](#), on page 19.

Remote command:

DET RMS, see [SENSe:] [WINDow:] DETector<trace> [:FUNCTION] on page 159

Average ← Detector ← Trace 1/Trace 2/Trace 3/Trace 4/Trace 5/Trace 6

Selects the "Average" detector.

For details see [Chapter 2.1.8, "Detector Overview"](#), on page 19.

Remote command:

DET AVER, see [SENSe:] [WINDow:] DETector<trace>[:FUNCTION]
on page 159

Quasipeak ← Detector ← Trace 1/Trace 2/Trace 3/Trace 4/Trace 5/Trace 6

Selects the "Quasipeak" detector.

The quasipeak detector is available with option R&S FSV-K54.

For details see [Chapter 2.1.8, "Detector Overview"](#), on page 19.

Remote command:

DET QPE, see [SENSe:] [WINDow:] DETector<trace>[:FUNCTION]
on page 159

CISPR Average ← Detector ← Trace 1/Trace 2/Trace 3/Trace 4/Trace 5/Trace 6

Selects the "CISPR Average" detector.

The CISPR Average detector is available with option R&S FSV-K54.

For details see [Chapter 2.1.8, "Detector Overview"](#), on page 19.

Remote command:

DET CAV, see [SENSe:] [WINDow:] DETector<trace>[:FUNCTION]
on page 159

RMS Average ← Detector ← Trace 1/Trace 2/Trace 3/Trace 4/Trace 5/Trace 6

Selects the "RMS Average" detector.

The quasipeak detector is available with option R&S FSV-K54.

For details see [Chapter 2.1.8, "Detector Overview"](#), on page 19.

Remote command:

DET CRMS, see [SENSe:] [WINDow:] DETector<trace>[:FUNCTION]
on page 159

More Traces

Opens a submenu to select one of the traces not currently displayed in the main menu.

Trace Wizard

Opens the "Trace Wizard" dialog. See [Chapter 2.1.6, "Configuring Traces"](#), on page 16.

Average Mode

Opens a submenu to select the averaging method for the average trace mode. The following methods are available:

- [Lin](#)
- [Log](#)
- [Power](#)

Logarithmic averaging is recommended to display signals with a low signal to noise ratio. While positive peak values are decreased in logarithmic averaging due to the characteristics involved, it is also true that negative peaks are increased relative to the average value. If the distorted amplitude distribution is averaged, a value is obtained that is smaller than the actual average value. The difference is -2.5 dB.

This low average value is usually corrected in noise power measurements by a 2.5 dB factor. Therefore the R&S FSVA/FSV offers the selection of linear averaging. The trace data is converted to linear values prior to averaging, then averaged and reconverted to logarithmic values. After these conversions the data is displayed on the screen. The average value is always correctly displayed irrespective of the signal characteristic.

In case of stationary sinusoidal signals both logarithmic and linear averaging has the same results.

Lin ← Average Mode

Activates linear averaging. Linear averaging means that the power level values are converted into linear units prior to averaging. After the averaging, the data is converted back into its original unit.

This softkey takes effect if the grid is set to a linear scale (see "Range Linear" softkey, "Range Linear %" on page 45). In this case, the averaging is done in two ways (depending on the set unit – see "Unit" softkey):

- The unit is set to either W or dBm: the data is converted into W prior to averaging, i.e. averaging is done in W.
- The unit is set to either V, A, dBmV, dBμV, dBμA or dBpW: the data is converted into V prior to averaging, i.e. averaging is done in V.

Remote command:

SENS: AVER1: TYPE LIN, see [SENSe:] AVERage<n>: TYPE on page 158

Log ← Average Mode

Activates logarithmic averaging.

This averaging method only takes effect if the grid is set to a logarithmic scale ("Range" softkey), i.e. the unit of the data is dBm. In this case the values are averaged in dBm. Otherwise (i.e. with linear scaling), the behavior is the same as with linear averaging (see Lin softkey). For further information on logarithmic scaling refer to the "Average Mode" softkey.

Remote command:

SENS: AVER1: TYPE VID, see [SENSe:] AVERage<n>: TYPE on page 158

Power ← Average Mode

Activates linear power averaging.

The power level values are converted into unit Watt prior to averaging. After the averaging, the data is converted back into its original unit.

Unlike the linear mode, the averaging is always done in W.

Remote command:

SENS: AVER1: TYPE POW, see [SENSe:] AVERage<n>: TYPE on page 158

ASCII Trace Export

Opens the "ASCII Trace Export Name" dialog box and saves the active trace in ASCII format to the specified file and directory.

Tip: You can export a single trace ("ASCII Trace Export Trace (x)" softkey) or all traces at the same time ("ASCII Trace Export All Traces"). When you use single trace export, the R&S FSV exports the currently selected trace (indicated by the softkey label). Note that the exported ASCII file has a slightly different structure compared to a single trace export.

The file consists of the header containing important scaling parameters and a data section containing the trace data. For details on an ASCII file see [Chapter 2.1.11, "ASCII File Export Format"](#), on page 23.

This format can be processed by spreadsheet calculation programs, e.g. MS-Excel. It is necessary to define ';' as a separator for the data import. Different language versions of evaluation programs may require a different handling of the decimal point. It is therefore possible to select between separators '.' (decimal point) and ',' (comma) using the "Decim Sep" softkey (see ["Decim Sep"](#) on page 63).

Remote command:

[FORMat:DEXPort:TRACes](#) on page 161

[FORMat:DEXPort:DSEParator](#) on page 185

[MMEMemory:STORe<n>:TRACe](#) on page 183

Decim Sep

Selects the decimal separator with floating-point numerals for the ASCII Trace export to support evaluation programs (e.g. MS-Excel) in different languages. The values '.' (decimal point) and ',' (comma) can be set.

Remote command:

[FORMat:DEXPort:DSEParator](#) on page 185

2.2.9 Softkeys of the Trigger Menu – TRIG Key (Analog Demodulation)

The following table shows all softkeys available in the "Trigger" menu in "Analog Demodulation" mode (TRIG key). It is possible that your instrument configuration does not provide all softkeys. If a softkey is only available with a special option, model or (measurement) mode, this information is delivered in the corresponding softkey description.

Trigger Source.....	64
L Free Run.....	64
L External.....	64
L RF Power.....	64
L IF Power.....	65
L FM.....	65
L AM.....	65
L PM.....	65
L RF.....	65
L Time.....	66
Trigger Level.....	66
Trigger Polarity.....	66

Trigger Offset.....	66
Repetition Interval.....	67
Trigger Hysteresis.....	67
Trigger Holdoff.....	67

Trigger Source

Opens the "Trg Source" submenu to select the trigger source.

In "Analog Demodulation" mode, the next measurement is triggered if the selected input signal exceeds the threshold specified using the "Trigger Level" softkey (see "Trigger Level" on page 66). A periodic signal modulated onto the carrier frequency can be displayed in this way. It is recommended that the measurement time covers at least five periods of the audio signal.

For triggering with AM, FM, PM or RF trigger sources to be successful, the measurement time must cover at least 5 periods of the audio signal.

Remote command:

TRIGger<n>[:SEquence]:SOURce on page 167

Free Run ← Trigger Source

The start of a sweep is not triggered. Once a measurement is completed, another is started immediately.

Remote command:

TRIG:SOUR IMM, see TRIGger<n>[:SEquence]:SOURce on page 167

External ← Trigger Source

Defines triggering via a TTL signal at the "EXT TRIG/GATE IN" input connector on the rear panel.

Remote command:

TRIG:SOUR EXT, see TRIGger<n>[:SEquence]:SOURce on page 167

RF Power ← Trigger Source

Defines triggering of the measurement via signals which are outside the measurement channel.

This trigger mode is available with detector board 1307.9554.02 Rev 05.00 or higher. It is not available for input from the R&S Digital I/Q Interface (option R&S FSV-B17). If RF Power trigger mode is selected and digital baseband input is activated, the trigger mode is automatically switched to "Free Run".

RF power triggers are not available together with the bandwidth extension option R&S FSV-B160.

In RF Power trigger mode the instrument uses a level detector at the first intermediate frequency. The detector threshold can be selected in a range between - 50 dBm and -10 dBm at the input mixer. The resulting trigger level at the RF input lies within the following range:

$(-24\text{dBm} + \text{RF Att}) \leq \text{Triggerlevel} \leq (+5\text{dBm} + \text{RF Att}), \text{ max. } 30 \text{ dBm}, \text{ for Preamp} = \text{OFF}$

$(-40\text{dBm} + \text{RF Att}) \leq \text{Triggerlevel} \leq (-11\text{dBm} + \text{RF Att}), \text{ max. } 30 \text{ dBm}, \text{ for Preamp} = \text{ON}$

with

500 MHz ≤ InputSignal ≤ 7 GHz

Note: If input values outside of this range occur (e.g. for fullspan measurements), the sweep may be aborted and a message indicating the allowed input values is displayed in the status bar.

Remote command:

TRIG:SOUR RFP, see TRIGger<n>[:SEQuence]:SOURce on page 167

SWE:EGAT:SOUR RFP for gated triggering, see [SENSe:]SWEep:EGATe:SOURce on page 156

IF Power ← Trigger Source

Defines triggering of the measurement via signals which are outside the measurement channel.

For this purpose, the R&S FSVA/FSV uses a level detector at the second intermediate frequency.

The available trigger levels depend on the RF attenuation and preamplification. A reference level offset, if defined, is also considered.

For details on available trigger levels and trigger bandwidths see the data sheet.

The bandwidth at the intermediate frequency is 20 MHz. The R&S FSVA/FSV is triggered as soon as the trigger level is exceeded within a 10 MHz range around the selected frequency (= start frequency in the frequency sweep).

Thus, the measurement of spurious emissions, e.g. for pulsed carriers, is possible even if the carrier lies outside the selected frequency span.

IF power triggers are not available together with the bandwidth extension option R&S FSV-B160.

Remote command:

TRIG:SOUR IFP, see TRIGger<n>[:SEQuence]:SOURce on page 167

SWE:EGAT:SOUR IFP for gated triggering, see [SENSe:]SWEep:EGATe:SOURce on page 156

FM ← Trigger Source

Triggers on the specified frequency level of the FM signal.

Remote command:

TRIG:SEQ:SOUR FM, see TRIGger<n>[:SEQuence]:SOURce on page 167

AM ← Trigger Source

Triggers on the specified modulation depth of the AM signal.

Remote command:

TRIG:SEQ:SOUR AMR, see TRIGger<n>[:SEQuence]:SOURce on page 167

PM ← Trigger Source

Triggers on the specified phase of the PM signal.

Remote command:

TRIG:SEQ:SOUR PM, see TRIGger<n>[:SEQuence]:SOURce on page 167

RF ← Trigger Source

Triggers on the specified level of the RF signal.

Note: The RF **offline** trigger is based on the I/Q data of the demodulated signal, limited to the demodulation bandwidth. For a wider trigger bandwidth and triggering based on the currently measured RF input signal, use the more powerful **RF Power** trigger.

Remote command:

TRIG:SEQ:SOUR AM, see TRIGger<n>[:SEQuence]:SOURce on page 167

Time ← Trigger Source

Opens an edit dialog box to define a repetition interval in which the measurement is triggered. The shortest interval is 2 ms.

Remote command:

TRIG:SOUR TIME:TRIGger<n>[:SEQuence]:SOURce on page 167

Trigger Level

Defines the trigger level as a numeric value.

In the trigger mode "Time", this softkey is not available.

Remote command:

TRIGger<n>[:SEQuence]:LEVel:IFPower on page 165

For digital input via the R&S Digital I/Q Interface, R&S FSV-B17:

TRIGger<n>[:SEQuence]:LEVel:BBPower on page 165

Trigger Polarity

Sets the polarity of the trigger source.

The sweep starts after a positive or negative edge of the trigger signal. The default setting is "Pos". The setting applies to all modes with the exception of the "Free Run" and "Time" mode.

"Pos" Level triggering: the sweep is stopped by the logic "0" signal and restarted by the logical "1" signal after the gate delay time has elapsed.

"Neg" Edge triggering: the sweep is continued on a "0" to "1" transition for the gate length duration after the gate delay time has elapsed.

Remote command:

TRIGger<n>[:SEQuence]:SLOPe on page 167

[SENSe:]SWEep:EGATe:POLarity on page 156

Trigger Offset

Opens an edit dialog box to enter the time offset between the trigger signal and the start of the sweep. The time may be entered in multiples of 125 ns in the range -13 s to 13 s (default 0 s).

offset > 0:	start of the sweep is delayed
offset < 0:	<p>sweep starts earlier (pre-trigger)</p> <p>only possible for span = 0 and gated trigger switched off</p> <p>not possible if RMS or average detector activated</p> <p>maximum allowed range and the maximum resolution limited by the sweep time:</p> <ul style="list-style-type: none"> • $\text{range}_{\text{max}} = -499/500 \times \text{sweep time}$ • $\text{resolution}_{\text{max}} = \text{sweep time}/500$

In the trigger mode **Time**, this softkey is not available.

For details on the relation between demodulation bandwidth and trigger offset refer to [Chapter 2.1.3, "Sample Rate, Measurement Time and Trigger Offset"](#), on page 13.

Remote command:

[TRIGger<n>\[:SEquence\]:HOLDoff\[:TIME\]](#) on page 163

Repetition Interval

Opens an edit dialog box to define a repetition interval in which the measurement is triggered. The shortest interval is 2 ms. This softkey is only available if the trigger source "Time" is selected (see "**Time**" on page 66).

Remote command:

[TRIGger<n>\[:SEquence\]:TIME:RINTerval](#) on page 166

Trigger Hysteresis

Defines the value for the trigger hysteresis for "IF power" or "RF Power" trigger sources. The hysteresis in dB is the value the input signal must stay below the power trigger level in order to allow a trigger to start the measurement. The range of the value is between 3 dB and 50 dB with a step width of 1 dB.

Remote command:

[TRIGger<n>\[:SEquence\]:IFPower:HYSteresis](#) on page 164

Trigger Holdoff

Defines the value for the trigger holdoff. The holdoff value in s is the time which must pass before triggering, in case another trigger event happens.

This softkey is only available if "IFPower", "RF Power" or "BBPower" is the selected trigger source.

Remote command:

[TRIGger<n>\[:SEquence\]:IFPower:HOLDoff](#) on page 163

For digital input via the R&S Digital I/Q Interface, R&S FSV-B17:

[TRIGger<n>\[:SEquence\]:BBPower:HOLDoff](#) on page 163

2.2.10 Softkeys of the Marker Menu – MKR key (Analog Demodulation)

The following table shows all softkeys available in the "Marker" menu in "Analog Demodulation" mode (MKR key). It is possible that your instrument configuration does not provide all softkeys. If a softkey is only available with a special option, model or (measurement) mode, this information is provided in the corresponding softkey description.

Marker 1 / Marker 2 / Marker 3 / ... Marker 16, / Marker Norm/Delta	68
More Markers	68
Marker to Trace	68
Marker Wizard	68
L All Marker Off	69
All Marker Off	69
Marker Table	70
Marker Stepsize	70

L Stepsize Standard.....	70
L Stepsize Sweep Points.....	70
Marker Zoom (span > 0).....	71
Link Mkr1 and Delta1.....	71
Link Time Marker.....	71
Link AF Spectrum Marker.....	71

Marker 1 / Marker 2 / Marker 3 / ... Marker 16,/ Marker Norm/Delta

The "Marker X" softkey activates the corresponding marker and opens an edit dialog box to enter a value for the marker to be set to. Pressing the softkey again deactivates the selected marker.

If a marker value is changed using the rotary knob, the step size is defined via the [Stepsize Standard](#) or [Stepsize Sweep Points](#) softkeys.

Marker 1 is always the reference marker for relative measurements. If activated, markers 2 to 16 are delta markers that refer to marker 1. These markers can be converted into markers with absolute value display using the "Marker Norm/Delta" softkey. If marker 1 is the active marker, pressing the "Marker Norm/Delta" softkey switches on an additional delta marker.

Remote command:

`CALCulate<n>:MARKer<m>[:STATe]` on page 104

`CALCulate<n>:MARKer<m>:X` on page 105

`CALCulate<n>:MARKer<m>:Y?` on page 107

`CALCulate<n>:DELTAmarker<m>[:STATe]` on page 174

`CALCulate<n>:DELTAmarker<m>:X` on page 175

`CALCulate<n>:DELTAmarker<m>:X:RELative?` on page 175

`CALCulate<n>:DELTAmarker<m>:Y?` on page 176

More Markers

Opens a sub-menu to select one of up to 16 available markers. See "[Marker 1 / Marker 2 / Marker 3 / ... Marker 16,/ Marker Norm/Delta](#)" on page 68.

Marker to Trace

Opens an edit dialog box to enter the number of the trace on which the marker is to be placed.

Remote command:

`CALCulate<n>:MARKer<m>:TRACe` on page 105

Marker Wizard

Opens a configuration dialog for markers. The marker wizard allows you to configure and activate up to 16 different markers in one dialog. The first 8 markers are displayed on one tab, the last 8 markers on a second tab. For each marker, the following settings are available:



"Selected/
State" When you press the "Selected" or "State" field the corresponding marker is activated and the marker row is highlighted.

"Normal/Delta" Defines whether it is a normal marker or delta marker. For delta markers you can define a reference marker.

"Ref. Marker" Reference marker for delta markers. The marker values for the delta marker are indicated relative to the specified reference marker. The reference marker can either be another active marker, or a fixed reference marker ("FXD", see "Ref Fixed" on page 72).

"Trace" Trace for which the marker is to be set.

Remote command:

[CALCulate<n>:MARKer<m>\[:STATe\]](#) on page 104

[CALCulate<n>:DELTAmarker<m>\[:STATe\]](#) on page 174

[CALCulate<n>:MARKer<m>:TRACe](#) on page 105

[CALCulate<n>:DELTAmarker<m>:TRACe](#) on page 174

[CALCulate<n>:DELTAmarker<m>:MREF](#) on page 174

All Marker Off ← Marker Wizard

Switches all markers off. It also switches off all functions and displays that are associated with the markers/delta markers.

Remote command:

[CALCulate<n>:MARKer<m>:AOFF](#) on page 98

All Marker Off

Switches all markers off. It also switches off all functions and displays that are associated with the markers/delta markers.

Remote command:

[CALCulate<n>:MARKer<m>:AOFF](#) on page 98

Marker Table

Defines how the marker information is displayed.

For more information, see "Displayed Marker Information" in the description of the base unit.

"On"	Displays the marker information in a table in a separate area beneath the diagram.
"Off"	Displays the marker information within the diagram area.
"Aut"	(Default) The marker table is displayed automatically if more than 2 markers are active, and removed if only 1 or 2 markers are active. This helps keep the information in the display clear.

Remote command:

[DISPlay:MTABLE](#) on page 109

Marker Stepsize

Opens a submenu to set the step size of all markers and delta markers.

Default value for the marker step size is [Stepsize Sweep Points](#).

Stepsize Standard ← Marker Stepsize

Moves the marker or delta marker from one measurement point to the next, if the marker or delta marker value is changed via the rotary knob ("Marker 1 / Marker 2 / Marker 3 / ... Marker 16, / Marker Norm/Delta" softkeys, see "[Marker 1 / Marker 2 / Marker 3 / ... Marker 16, / Marker Norm/Delta](#)" on page 68). If more measured values than measurement points exist, it is not possible to read out all measured values. In this case, use the [Stepsize Sweep Points](#) softkey.

Remote command:

`CALC:MARK:X:SSIZ STAN` (see [CALCulate<n>:MARKer<m>:X:SSIZE](#) on page 107)

Stepsize Sweep Points ← Marker Stepsize

Moves the marker or delta marker from one measured value to the next, if the marker or delta marker value is changed via the rotary knob ("Marker 1 / Marker 2 / Marker 3 / ... Marker 16, / Marker Norm/Delta" softkeys, see "[Marker 1 / Marker 2 / Marker 3 / ... Marker 16, / Marker Norm/Delta](#)" on page 68). If more measured values than measurement points exist, every single measured value is accessible and its value is displayed in the marker field.

The number of measured values is defined in the ""Sweep"" menu via the [Sweep Points](#) softkey.

This functionality is available for all base unit measurements with the exception of statistics ("APD" and "CCDF" softkeys in the "Measurement" menu).

Remote command:

`CALC:MARK:X:SSIZ POIN` (see [CALCulate<n>:MARKer<m>:X:SSIZE](#) on page 107)

Marker Zoom (span > 0)

Opens an edit dialog box to enter a display range for the zoom. The area around marker 1 is expanded accordingly and more details of the result can be seen. If no marker is activated, marker 1 is switched on and set on the largest signal.

The following sweep is stopped at the position of the reference marker. The frequency of the signal is counted and the measured frequency becomes the new center frequency. The zoomed display range is then configured and the new settings are used by the R&S FSV for further measurements.

If the display has not yet been switched to the new frequency display range and you press the softkey, the procedure is aborted. If an instrument setting is changed during this operation, the procedure is also aborted.

Remote command:

[CALCulate<n>:MARKer<m>:FUNCTION:ZOOM](#) on page 95

Link Mkr1 and Delta1

The delta marker 1 is linked to marker 1, so if the x-axis value of the marker 1 is changed, the delta marker 1 will follow on the same x-position. The link is off by default.

You can set the two markers on different traces to measure the difference (e.g. between a max hold trace and a min hold trace or between a measurement and a reference trace).

Remote command:

[CALCulate<n>:DELTAmarker<m>:LINK](#) on page 173

Link Time Marker

Links the markers in all time domain diagrams.

Remote command:

[CALCulate<n>:MARKer<m>:LINK](#) on page 96

Link AF Spectrum Marker

Links the markers in all AF spectrum displays.

Remote command:

[CALCulate<n>:MARKer<m>:LINK](#) on page 96

2.2.11 Softkeys of the Marker Function Menu – MKR FUNC Key (Analog Demodulation)

The following table shows all softkeys available in the "Marker Function" menu.

Select Marker (No).....	72
Phase Noise.....	72
Ref Fixed.....	72
L Ref. Fixed On/Off.....	72
L Ref Point Level.....	72
L Ref Point Frequency (span > 0)/Ref Point Time (zero span).....	73
L Peak Search.....	73
n dB down.....	73

Marker Peak List.....	74
L Peak List On/Off.....	74
L Sort Mode Freq/Lvl.....	74
L Max Peak Count.....	74
L Peak Excursion.....	74
L Left Limit.....	74
L Right Limit.....	75
L Threshold.....	75
L ASCII File Export.....	75
L Decim Sep.....	75
L Marker Number.....	75

Select Marker (No)

Opens a submenu to select one of 16 markers and define whether the marker is a normal or a delta marker (see "[Marker 1 / Marker 2 / Marker 3 / ... Marker 16, / Marker Norm/Delta](#)" on page 68). "(No)" indicates the number of the currently active marker.

See "[Marker 1 / Marker 2 / Marker 3 / ... Marker 16, / Marker Norm/Delta](#)" on page 68.

Phase Noise

For AF spectrum displays, the Phase Noise marker is a normal marker with a special display value.

Remote command:

`CALCulate<n>:MARKer<m>:FUNCTION:PNOise:RESult?` on page 93

`CALCulate<n>:MARKer<m>:FUNCTION:PNOise:RESult?` on page 93

Ref Fixed

Opens a submenu to set all values of a reference point. Instead of using the current values of the reference marker (marker 1) as reference point for the delta markers, level and frequency or time are set to fixed values and used as reference point.

Ref. Fixed On/Off ← Ref Fixed

Switches the relative measurement to a fixed reference value on or off. The level and frequency or time values of marker 1 immediately become the reference point, but can be altered using the corresponding softkeys ("[Ref Point Level](#)" on page 72, "[Ref Point Frequency \(span > 0\)/Ref Point Time \(zero span\)](#)" on page 73 and "[Peak Search](#)" on page 73).

When set to ON, all delta markers which previously referenced marker 1 are automatically set to reference the fixed marker.

The reference marker assignment can be changed using the "Marker Wizard" (see "[Marker Wizard](#)" on page 68).

Remote command:

`CALCulate<n>:DELTAmarker<m>:FUNCTION:FIXed[:STATe]` on page 172

Ref Point Level ← Ref Fixed

Opens an edit dialog box to enter a reference level value. All relative level values of the delta markers refer to this reference level.

Remote command:

`CALCulate<n>:DELTAmarker<m>:FUNCTION:FIXed:RPoint:Y` on page 171

Ref Point Frequency (span > 0)/Ref Point Time (zero span) ← Ref Fixed

Opens an edit dialog box to enter a frequency reference or time value. All relative frequency or time values of the delta markers refer to this frequency reference. For phase noise measurement, input of reference time is not possible.

Remote command:

`CALCulate<n>:DELTAmarker<m>:FUNction:FIXed:RPoint:X` on page 171

Peak Search ← Ref Fixed

Sets the maximum value of the selected trace as the reference point.

Remote command:

`CALCulate<n>:DELTAmarker<m>:FUNction:FIXed:RPoint:MAXimum[:PEAK]`
on page 170

n dB down

Opens an edit dialog box to enter a value to define the level spacing of the two temporary markers to the right and left of marker 1 (default setting: 3 dB). Activates the temporary markers T1 and T2. The values of the temporary markers (T1, T2) and the entered value (ndB) are displayed in the marker field.

If a positive value is entered, the markers T1 and T2 are placed below the active reference marker. If a negative value (e.g. for notch filter measurements) is entered, the markers T1 and T2 are placed above the active reference marker. Marker T1 is placed to the left and marker T2 to the right of the reference marker.

In the marker table, the following results are displayed:

Span setting	Parameter name	Description
span > 0	Bw	frequency spacing of the two temporary markers
	Q factor	quality of the displayed bandwidth value (Bw)
span = 0	PWid	pulse width between the two temporary markers

If it is not possible to form the frequency spacing for the n dB value (e.g. because of noise display), dashes instead of a measured value are displayed.

Remote command:

`CALC:MARK1:FUNC:NDBD:STAT ON`, see `CALCulate<n>:MARKer<m>:FUNction:NDBDown:STATe` on page 103

`CALC:MARK1:FUNC:NDBD 3dB`, see `CALCulate<n>:MARKer<m>:FUNction:NDBDown` on page 100

`CALC:MARK1:FUNC:NDBD:RES?`, see `CALCulate<n>:MARKer<m>:FUNction:NDBDown:RESult?` on page 102

`CALC:MARK:FUNC:NDBD:QFAC?`, see `CALCulate<n>:MARKer<m>:FUNction:NDBDown:QFACTOR` on page 102

`CALC:MARK1:FUNC:NDBD:FREQ?` (span > 0), see `CALCulate<n>:MARKer<m>:FUNction:NDBDown:FREQuency?` on page 101

`CALC:MARK1:FUNC:NDBD:TIME?` (span = 0), see `CALCulate<n>:MARKer<m>:FUNction:NDBDown:TIME?` on page 103

Marker Peak List

Opens the "Peak List" submenu to define criteria for the sort order and the contents of the peak list. For each listed peak the frequency ("Stimulus") and level ("Response") values are given. In addition, the peaks are indicated in the trace display. A maximum of 50 entries are listed.

Remote command:

[CALCulate<n>:MARKer<m>:FUNCTION:FPEaks:COUNT?](#) on page 98

[CALCulate<n>:MARKer<m>:FUNCTION:FPEaks:X](#) on page 99

[CALCulate<n>:MARKer<m>:FUNCTION:FPEaks:Y?](#) on page 100

Peak List On/Off ← Marker Peak List

Activates/deactivates the marker peak list. If activated, the peak list is displayed and the peaks are indicated in the trace display.

Remote command:

[CALCulate<n>:MARKer<m>:FUNCTION:FPEaks:STAT](#) on page 95

Sort Mode Freq/Lvl ← Marker Peak List

Defines the criteria for sorting:

"Freq" sorting in ascending order of frequency values (span > 0) or time values (span = 0)

"Lvl" sorting in ascending order of the level

Remote command:

[CALCulate<n>:MARKer<m>:FUNCTION:FPEaks:SORT](#) on page 99

Max Peak Count ← Marker Peak List

Defines the maximum number of peaks to be determined and displayed.

Remote command:

[CALCulate<n>:MARKer<m>:FUNCTION:FPEaks:LIST:SIZE](#) on page 94

Peak Excursion ← Marker Peak List

Opens an edit dialog box for level measurements to enter the minimum level value by which a signal must rise or fall so that it will be identified as a maximum or a minimum by the search functions. Entries from 0 dB to 80 dB are allowed; the resolution is 0.1 dB. The default setting for the peak excursion is 6 dB.

For more information see "Specifying the suitable peak excursion" and "Effect of different peak excursion settings".

Remote command:

[CALCulate<n>:MARKer<m>:PEXCursion](#) on page 104

Left Limit ← Marker Peak List

Opens an edit dialog box to enter a value for the lower limit (left vertical line: S1 for span > 0; T1 for zero span). The search is performed between the lines of the left and right limit (see also [Right Limit](#) softkey).

Remote command:

[CALCulate<n>:MARKer<m>:X:SLIMits:LEFT](#) on page 106

Right Limit ← Marker Peak List

Opens an edit dialog box to enter a value for the upper limit (left vertical line: S2 for span > 0; T2 for zero span). The search is performed between the lines of the left and right limit (see also [Left Limit](#) softkey). If no value is set, the upper limit corresponds to the stop frequency.

Remote command:

[CALCulate<n>:MARKer<m>:X:SLIMits:RIGHT](#) on page 106

Threshold ← Marker Peak List

Opens an edit dialog box to define the threshold line. The threshold line represents the lower level limit for a "Peak" search and the upper level limit for a "Min" search.

Remote command:

[CALCulate<n>:THReshold:STATe](#) on page 97

[CALCulate<n>:THReshold](#) on page 96

ASCII File Export ← Marker Peak List

Opens the "ASCII File Export Name" dialog box and saves the active peak list in ASCII format to the specified file and directory.

The file consists of the header containing important scaling parameters and a data section containing the marker data. For details on an ASCII file see [Chapter 2.1.11, "ASCII File Export Format"](#), on page 23.

This format can be processed by spreadsheet calculation programs, e.g. MS-Excel. It is necessary to define ';' as a separator for the data import. Different language versions of evaluation programs may require a different handling of the decimal point. It is therefore possible to select between separators '.' (decimal point) and ',' (comma) using the "Decim Sep" softkey (see ["Decim Sep"](#) on page 63).

Remote command:

[FORMat:DEXPort:DSEParator](#) on page 185

[MMEMory:STORE<n>:LIST](#) on page 183

Decim Sep ← Marker Peak List

Selects the decimal separator with floating-point numerals for the ASCII Trace export to support evaluation programs (e.g. MS-Excel) in different languages. The values '.' (decimal point) and ',' (comma) can be set.

Remote command:

[FORMat:DEXPort:DSEParator](#) on page 185

Marker Number ← Marker Peak List

If enabled, the determined peaks are indicated by their corresponding marker number in the trace display.

Remote command:

[CALCulate<n>:MARKer<m>:FUNCTION:FPEaks:ANNotation:LABel:STATe](#) on page 94

2.2.12 Softkeys of the Input/Output Menu

The following table shows all softkeys available in the "Input/Output" menu. It is possible that your instrument configuration does not provide all softkeys. If a softkey is only available with a special option, model or (measurement) mode, this information is provided in the corresponding softkey description.

Input (AC/DC).....	76
Noise Source.....	76
Video Output.....	76
Tracking Generator.....	77
Power Sensor.....	77
Trigger Out.....	77
External Mixer.....	77
Probe Config.....	77
Signal Source.....	77
L Input Path.....	77
L Connected Device.....	78
L Input Sample Rate.....	78
L Full Scale Level.....	78
L Level Unit.....	78
L Adjust Reference Level to Full Scale Level.....	78
EXIQ.....	78
L TX Settings.....	79
L RX Settings.....	79
L Send To.....	79
L Firmware Update.....	79
L R&S Support.....	79
L DigIConf.....	79
Digital IQ Info.....	80

Input (AC/DC)

Toggles the RF input of the R&S FSVA/FSV between AC and DC coupling.

This function is not available for input from the R&S Digital I/Q Interface (option R&S FSV-B17).

Remote command:

[INPut:COUPling](#) on page 178

Noise Source

Switches the supply voltage for an external noise source on or off.

Remote command:

[DIAGnostic<n>:SERVice:NSOurce](#) on page 185

Video Output

Sends a video output signal according to the measured level to the connector on the rear panel of the R&S FSVA/FSV.

Note: Video output does not return valid values in IQ or FFT mode.

Remote command:

[OUTP:IF VID](#), see [OUTPut:IF\[:SOURce\]](#) on page 184

Tracking Generator

This softkey is only available if the R&S FSV option Tracking Generator (R&S FSV-B9) or External Tracking Generator (R&S FSV-B10) or both are installed. It is not available in I/Q Analyzer mode.

For details see the base unit description.

Power Sensor

For precise power measurement a power sensor can be connected to the instrument via the front panel (USB connector) or the rear panel (power sensor, option R&S FSV-B5). The Power Sensor Support firmware option (R&S FSV-K9) provides the power measurement functions for this test setup.

This softkey is only available if the Power Sensor option (R&S FSV-K9) is installed.

For details see the chapter "Instrument Functions Power Sensor (K9)" in the base unit description.

This softkey is available for RF measurements.

Trigger Out

Sets the Trigger Out port in the Additional Interfaces (option R&S FSV-B5 only) to low or high. Thus, you can trigger an additional device via the external trigger port, for example.

Remote command:

[OUTPut:TRIGger](#) on page 184

External Mixer

Opens the submenu for the external mixer.

For details see the base unit description.

Probe Config

With firmware R&S FSVA/FSV 1.61SP2 or newer, active probes are supported (via an adapter). This softkey opens an edit dialog box to activate and configure a connected probe which is to provide an input signal. It is only available if a probe is connected to the instrument's [RF Input] and USB connectors.

For details see the base unit Operating Manual.

Remote command:

[PROBe\[:STATe\]](#) on page 117

[PROBe:SETup:MODE](#) on page 117

Signal Source

Opens a dialog box to select the signal source.

For "Digital Baseband (I/Q)", the source can also be configured here.

Input Path ← Signal Source

Defines whether the "RF Radio Frequency" or the "Digital IQ" input path is used for measurements. "Digital IQ" is only available if option R&S FSV-B17 (R&S Digital I/Q Interface) is installed.

Note: Note that the input path defines the characteristics of the signal, which differ significantly between the RF input and digital input.

Remote command:

`INPut:SElect` on page 182

Connected Device ← Signal Source

Displays the name of the device connected to the optional R&S Digital I/Q Interface (R&S FSV-B17) to provide Digital IQ input. The device name cannot be changed here.

The device name is unknown.

Remote command:

`INPut:DIQ:CDEvice` on page 178

Input Sample Rate ← Signal Source

Defines the sample rate of the digital I/Q signal source. This sample rate must correspond with the sample rate provided by the connected device, e.g. a generator.

Remote command:

`INPut:DIQ:SRATe` on page 180

Full Scale Level ← Signal Source

The "Full Scale Level" defines the level that should correspond to an I/Q sample with the magnitude "1".

The level can be defined either in dBm or Volt.

Remote command:

`INPut:DIQ:RANGe[:UPPer]` on page 179

Level Unit ← Signal Source

Defines the unit used for the full scale level.

Remote command:

`INPut:DIQ:RANGe[:UPPer]:UNIT` on page 180

Adjust Reference Level to Full Scale Level ← Signal Source

If enabled, the reference level is adjusted to the full scale level automatically if any change occurs.

Remote command:

`INPut:DIQ:RANGe:COUPling` on page 179

EXIQ

Opens a configuration dialog box for an optionally connected R&S EX-IQ-BOX and a submenu to access the main settings quickly.

Note: The EX-IQ-Box functionality is not supported for R&S FSV models 1307.9002Kxx.

If the optional R&S DigIConf software is installed, the submenu consists only of one key to access the software. **Note that R&S DigIConf requires a USB connection (not LAN!) from the R&S FSVA/FSV to the R&S EX-IQ-BOX in addition to the R&S Digital I/Q Interface connection. R&S DigIConf version 2.10 or higher is required.**

For typical applications of the R&S EX-IQ-BOX see also the description of the R&S Digital I/Q Interface (R&S FSV-B17) in the base unit manual.

For details on configuration see the "R&S®Ex I/Q Box - External Signal Interface Module Manual".

For details on installation and operation of the R&S DigIConf software, see the "R&S®EX-IQ-BOX Digital Interface Module R&S®DigIConf Software Operating Manual".

TX Settings ← EXIQ

Opens the "EX-IQ-BOX Settings" dialog box to configure the R&S FSVA/FSV for digital output to a connected device ("Transmitter" Type).

RX Settings ← EXIQ

Opens the "EX-IQ-BOX Settings" dialog box to configure the R&S FSVA/FSV for digital input from a connected device ("Receiver" Type).

Send To ← EXIQ

The configuration settings defined in the dialog box are transferred to the R&S EX-IQ-BOX.

Firmware Update ← EXIQ

If a firmware update for the R&S EX-IQ-BOX is delivered with the R&S FSVA/FSV firmware, this function is available. In this case, when you select the softkey, the firmware update is performed.

R&S Support ← EXIQ

Stores useful information for troubleshooting in case of errors.

This data is stored in the `C:\R_S\Instr\user\Support` directory on the instrument.

If you contact the Rohde&Schwarz support to get help for a certain problem, send these files to the support in order to identify and solve the problem faster.

DigIConf ← EXIQ

Starts the optional R&S DigIConf application. This softkey is only available if the optional software is installed.

To return to the R&S FSVA/FSV application, press any key on the front panel. The application is displayed with the "EXIQ" menu, regardless of which key was pressed.

For details on the R&S DigIConf application, see the "R&S®EX-IQ-BOX Digital Interface Module R&S®DigIConf Software Operating Manual".

Note: If you close the R&S DigIConf window using the "Close" icon, the window is minimized, not closed.

If you select the "File > Exit" menu item in the R&S DigIConf window, the application is closed. Note that in this case the settings are lost and the EX-IQ-BOX functionality is no longer available until you restart the application using the "DigIConf" softkey in the R&S FSVA/FSV once again.

Remote command:

Remote commands for the R&S DiglConf software always begin with `SOURce:EBOX`. Such commands are passed on from the R&S FSVA/FSV to the R&S DiglConf automatically which then configures the R&S EX-IQ-BOX via the USB connection.

All remote commands available for configuration via the R&S DiglConf software are described in the "R&S®EX-IQ-BOX Digital Interface Module R&S®DiglConf Software Operating Manual".

Example 1:

`SOURce:EBOX:*RST`

`SOURce:EBOX:*IDN?`

Result:

"Rohde&Schwarz,DiglConf,02.05.436 Build 47"

Example 2:

`SOURce:EBOX:USER:CLOCK:REFerence:FREQuency 5MHZ`

Defines the frequency value of the reference clock.

Digital IQ Info

Displays a dialog box with information on the digital I/Q input and output connection via the optional R&S Digital I/Q Interface (R&S FSV-B17), if available. The information includes:

- Device identification
- Used port
- (Maximum) digital input/output sample rates and maximum digital input/output transfer rates
- Status of the connection protocol
- Status of the PRBS descewing test

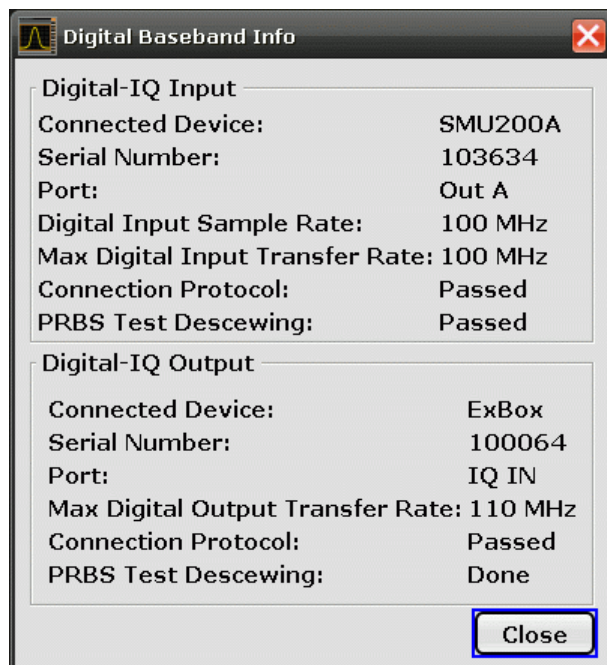

For details see "Interface Status Information" in "Instrument Functions - R&S Digital I/Q Interface (Option R&S FSV-B17)" in the description of the base unit.

Remote command:

[INPut:DIQ:CDEvice](#) on page 178

2.3 Remote Commands of the Analog Demodulation (R&S FSV-K7)

In this section all remote control commands specific to the Analog Demodulation option are described in detail. The abbreviation ADEMODO stands for the Analog Demodulation operating mode. For details on conventions used in this chapter refer to [Chapter 2.3.1, "Notation"](#), on page 82.

For further information on analyzer or basic settings commands, refer to the corresponding subsystem in the base unit description.

In particular, the following subsystems are identical to the base unit; refer to the base unit description:

- CALCulate:DELTaMarker
- CALCulate:MARKer (except for the K7-specific commands described in [Chapter 2.3.2, "CALCulate Subsystem \(Analog Demodulation, R&S FSV-K7\)"](#), on page 85)
- INITiate subsystem
- INPut subsystem
- OUTput subsystem

Subsystems of the Analog Demodulation (R&S FSV-K7)

2.3.1	Notation.....	82
2.3.2	CALCulate Subsystem (Analog Demodulation, R&S FSV-K7).....	85
2.3.2.1	CALCulate:MARKer:FUNCTion:ADEMODO Subsystem (Analog Demodulation, Analog Demodulation).....	85
2.3.2.2	Other CALCulate commands.....	90
2.3.2.3	Other Referenced CALCulate Commands.....	98
2.3.3	DISPlay Subsystem (Analog Demodulation, R&S FSV-K7).....	108
2.3.4	INSTrument Subsystem (Analog Demodulation, R&S FSV-K7).....	115
2.3.5	PROBe subsystem.....	116
2.3.6	SENSE subsystem (Analog Demodulation, R&S FSV-K7).....	117
2.3.6.1	Trace Mode Result Types.....	118
2.3.6.2	Formats for Returned Values: ASCII Format and Binary Format.....	118
2.3.6.3	SENSE:ADEMODO Subsystem (Analog Demodulation, Analog Demodulation).....	119
2.3.6.4	SENSE:ADJUST Subsystem.....	145
2.3.6.5	SENSE:BANDwidth Subsystem (Analog Demodulation, R&S FSV-K7).....	147

2.3.6.6	SENSE:FILTer Subsystem (Analog Demodulation, Analog Demodulation).....	148
2.3.6.7	SENSE:FREQuency Subsystem (Analog Demodulation, R&S FSV-K7).....	153
2.3.6.8	SENSE:SWEEp Subsystem (Analog Demodulation, R&S FSV-K7).....	155
2.3.6.9	Other commands in the SENSE subsystem.....	157
2.3.7	TRACe Subsystem (Analog Demodulation, R&S FSV-K7).....	160
2.3.7.1	Commands of the TRACe subsystem.....	160
2.3.7.2	Formats for Returned Values: ASCII Format and Binary Format.....	161
2.3.8	TRIGger Subsystem (Analog Demodulation, R&S FSV-K7).....	162
2.3.9	UNIT Subsystem (Analog Demodulation, R&S FSV-K7).....	169
2.3.10	Other Commands Referenced in this Manual.....	170
2.3.10.1	CALCulate:DELTaMarker Subsystem (Analog Demodulation, R&S FSV-K7).....	170
2.3.10.2	INPut subsystem.....	176
2.3.10.3	MMEMory subsystem.....	183
2.3.10.4	OUTPut subsystem.....	183
2.3.10.5	Other Commands.....	184

2.3.1 Notation

In the following sections, all commands implemented in the instrument are first listed and then described in detail, arranged according to the command subsystems. The notation is adapted to the SCPI standard. The SCPI conformity information is included in the individual description of the commands.

Individual Description

The individual description contains the complete notation of the command. An example for each command, the *RST value and the SCPI information are included as well.

The options and operating modes for which a command can be used are indicated by the following abbreviations:

Abbreviation	Description
A	spectrum analysis
A-F	spectrum analysis – span > 0 only (frequency mode)
A-T	spectrum analysis – zero span only (time mode)
ADEMODO	analog demodulation (option R&S FSV-K7)
BT	Bluetooth (option R&S FSV-K8)
CDMA	CDMA 2000 base station measurements (option R&S FSV-K82)
EVDO	1xEV-DO base station analysis (option R&S FSV-K84)

GSM	GSM/Edge measurements (option R&S FSV-K10)
IQ	IQ Analyzer mode
OFDM	WiMAX IEEE 802.16 OFDM measurements (option R&S FSV-K93)
OFDMA/WiBro	WiMAX IEEE 802.16e OFDMA/WiBro measurements (option R&S FSV-K93)
NF	Noise Figure measurements (R&S FSV-K30)
PHN	Phase Noise measurements (R&S FSV-K40)
PSM	Power Sensor measurements (option R&S FSV-K9)
SFM	Stereo FM measurements (option R&S FSV-K7S)
SPECM	Spectrogram mode (option R&S FSV-K14)
TDS	TD-SCDMA base station / UE measurements (option R&S FSV-K76/K77)
VSA	Vector Signal Analysis (option R&S FSV-K70)
WCDMA	3GPP Base Station measurements (option R&S FSV-K72), 3GPP UE measurements (option R&S FSV-K73)
WLAN	WLAN TX measurements (option R&S FSV-K91)



The spectrum analysis mode is implemented in the basic unit. For the other modes, the corresponding options are required.

Upper/Lower Case Notation

Upper/lower case letters are used to mark the long or short form of the key words of a command in the description. The instrument itself does not distinguish between upper and lower case letters.

Special Characters

	A selection of key words with an identical effect exists for several commands. These keywords are indicated in the same line; they are separated by a vertical stroke. Only one of these keywords needs to be included in the header of the command. The effect of the command is independent of which of the keywords is used.
--	---

Example:

```
SENSe:FREQuency:CW|:FIXed
```

The two following commands with identical meaning can be created. They set the frequency of the fixed frequency signal to 1 kHz:

```
SENSe:FREQuency:CW 1E3
```

```
SENSe:FREQuency:FIXed 1E3
```

A vertical stroke in parameter indications marks alternative possibilities in the sense of "or". The effect of the command differs, depending on which parameter is used.

Example: Selection of the parameters for the command

```
[SENSe<1...4>:]AVERage<1...4>:TYPE VIDEo | LINear
```

[]	Key words in square brackets can be omitted when composing the header. The full command length must be accepted by the instrument for reasons of compatibility with the SCPI standards. Parameters in square brackets can be incorporated optionally in the command or omitted as well.
{ }	Parameters in braces can be incorporated optionally in the command, either not at all, once or several times.

Description of Parameters

Due to the standardization, the parameter section of SCPI commands consists always of the same syntactical elements. SCPI has therefore specified a series of definitions, which are used in the tables of commands. In the tables, these established definitions are indicated in angled brackets (<...>) and is briefly explained in the following.

For details see the chapter "SCPI Command Structure" in the base unit description.

<Boolean>

This keyword refers to parameters which can adopt two states, "on" and "off". The "off" state may either be indicated by the keyword OFF or by the numeric value 0, the "on" state is indicated by ON or any numeric value other than zero. Parameter queries are always returned the numeric value 0 or 1.

<numeric_value> <num>

These keywords mark parameters which may be entered as numeric values or be set using specific keywords (character data). The following keywords given below are permitted:

- MAXimum: This keyword sets the parameter to the largest possible value.
- MINimum: This keyword sets the parameter to the smallest possible value.
- DEFault: This keyword is used to reset the parameter to its default value.
- UP: This keyword increments the parameter value.
- DOWN: This keyword decrements the parameter value.

The numeric values associated to MAXimum/MINimum/DEFault can be queried by adding the corresponding keywords to the command. They must be entered following the quotation mark.

Example:

```
SENSe:FREQuency:CENTer? MAXimum
```

Returns the maximum possible numeric value of the center frequency as result.

<arbitrary block program data>

This keyword is provided for commands the parameters of which consist of a binary data block.

2.3.2 CALCulate Subsystem (Analog Demodulation, R&S FSV-K7)

The CALCulate subsystem contains commands for converting instrument data, transforming and carrying out corrections. These functions are carried out subsequent to data acquisition, i.e. following the SENSE subsystem.

2.3.2.1	CALCulate:MARKer:FUNCTion:ADEMod Subsystem (Analog Demodulation, Analog Demodulation).....	85
2.3.2.2	Other CALCulate commands.....	90
2.3.2.3	Other Referenced CALCulate Commands.....	98

2.3.2.1 CALCulate:MARKer:FUNCTion:ADEMod Subsystem (Analog Demodulation, Analog Demodulation)

The CALCulate:MARKer:FUNCTion:ADEMod subsystem contains the marker functions for the Analog Demodulation mode.

Commands of the CALCulate:MARKer:FUNCTion:ADEMod Subsystem

CALCulate<n>:MARKer:FUNCTion:ADEMod:AFRequency[:RESult<t>]?	85
CALCulate<n>:MARKer:FUNCTion:ADEMod:AM[:RESult<t>]?	86
CALCulate<n>:MARKer:FUNCTion:ADEMod:CARRier[:RESult<t>]?	87
CALCulate<n>:MARKer:FUNCTion:ADEMod:FERRor[:RESult<t>]?	87
CALCulate<n>:MARKer:FUNCTion:ADEMod:FM[:RESult<t>]?	88
CALCulate<n>:MARKer:FUNCTion:ADEMod:PM[:RESult<t>]?	89
CALCulate<n>:MARKer:FUNCTion:ADEMod:SINad:RESult<t>?	89
CALCulate<n>:MARKer:FUNCTion:ADEMod:THD:RESult<t>?	90

CALCulate<n>:MARKer:FUNCTion:ADEMod:AFRequency[:RESult<t>]?

This command queries the audio frequency with analog demodulation in the specified window.

If several demodulation modes are activated simultaneously (e.g. with the [SENSE:]ADEMod:FM[:TDOMain] [:TYPE] command, the audio frequency of the display mode selected with CALCulate<n>:FEED on page 90 is returned.

Suffix:

<n>	1 window
<t>	1...6 irrelevant

Example:	ADEM ON, see [SENSe:]ADEMod[:STATe] on page 121 Switches on analog demodulator CALC:FEED 'XTIM:AM:TDOM', see CALCulate<n>:FEED on page 90 Switches on AM result display. DISP:TRAC ON, see DISPlay[:WINDow<n>]:TRACe<t>[:STATe] on page 111 Switches the trace on. CALC:MARK:FUNC:ADEM:AFR? Queries the audio frequency.
Usage:	Query only
Mode:	ADEM0D

CALCulate<n>:MARKer:FUNCTION:ADEMod:AM[:RESult<t>]? <Result>
CALCulate<n>:MARKer:FUNCTION:ADEMod:AM[:RESult<t>]?? <MeasType>

This command queries the results of the AM modulation measurement.

Suffix:

<n>	1...4 irrelevant
<t>	1...6 trace 1, 2, 3, 4, 5 or 6

Parameters:

<Result> The result of the selected measurement type is returned.

Query parameters:

<MeasType>	PPEak MPEak MIDDLE RMS
	PPEak Measurement with detector Pluspeak (+PK)
	MPEak Measurement with detector MinusPeak (-PK)
	MIDDLE Averaging \pm PK/2
	RMS RMS measurement

Example:	ADEM ON (see [SENSe:]ADEMod[:STATe] on page 121) Switches on the analog demodulator. CALC:FEED 'XTIM:AM:TDOM', see CALCulate<n>:FEED on page 90 Switches on the AM result display. DISP:TRAC ON, see DISPlay[:WINDow<n>]:TRACe<t>[:STATe] on page 111 Switches on the trace. CALC:MARK:FUNC:ADEM:AM? PPE Queries the peak value.
-----------------	---

Usage: Query only
Mode: ADEM0D

CALCulate<n>:MARKer:FUNCTION:ADEMod:CARRier[:RESult<t>]?

This command queries the carrier power.

With RF Power result display, the carrier power is determined from trace 1 to 6 indicated in the suffix. With all other result displays, the carrier power is determined from the current trace data (CLR/WRITE trace).

Suffix:

<n>	1...4 irrelevant
<t>	1...6 irrelevant

Example: ADEM ON (see [SENSe:]ADEMod[:STATe] on page 121)
 Switches on analog demodulator
 CALC:FEED 'XTIM:RFP', see CALCulate<n>:FEED
 on page 90
 Switches on RF power result display
 CALC:MARK:FUNC:ADEM:CARR?
 Queries the carrier power

Usage: Query only
Mode: ADEM0D

CALCulate<n>:MARKer:FUNCTION:ADEMod:FERRor[:RESult<t>]?

This command queries the frequency error with FM and PM demodulation. The frequency error is determined from the current measurement data (CLR/WRITE trace).

The offset thus determined differs from that calculated in the [SENSe:]ADEMod:FM:OFFSet on page 132 command since, for determination of the frequency deviation, the modulation is removed by means of low pass filtering, producing results that are different from those obtained by averaging with the SENSe command.

Suffix:

<n>	1...4 irrelevant
<t>	1...6 irrelevant

Example:	ADEM ON (see [SENSe:]ADEMod[:STATe] on page 121) Switches on analog demodulator CALC:FEED 'XTIM:FM:TDOM', see CALCulate<n>:FEED on page 90 Switches on FM result display CALC:MARK:FUNC:ADEM:FERR? Queries the frequency error of trace 1
Usage:	Query only
Mode:	ADEMOD

CALCulate<n>:MARKer:FUNCTION:ADEMod:FM[:RESult<t>]? <Result>
CALCulate<n>:MARKer:FUNCTION:ADEMod:FM[:RESult<t>]?? <MeasType>

This command queries the results of FM modulation measurement.

Suffix:

<n>	1...4 irrelevant
<t>	1...6 trace 1, 2, 3, 4, 5 or 6

Parameters:

<Result>	The result of the selected measurement type is returned.
----------	--

Query parameters:

<MeasType>	PPEak MPEak MIDDLE RMS
	PPEak Measurement with detector Pluspeak (+PK)
	MPEak Measurement with detector MinusPeak (-PK)
	MIDDLE Averaging \pm PK/2
	RMS RMS measurement

Example:	ADEM ON (see [SENSe:]ADEMod[:STATe] on page 121) Switches on the analog demodulator. CALC:FEED 'XTIM:FM:TDOM', see CALCulate<n>:FEED on page 90 Switches on the FM result display. CALC:MARK:FUNC:ADEM:FM? PPE Queries the peak value.
Usage:	Query only
Mode:	ADEMOD

CALCulate<n>:MARKer:FUNCtion:ADEMod:PM[:RESult<t>]? <Result>
CALCulate<n>:MARKer:FUNCtion:ADEMod:PM[:RESult<t>]?? <MeasType>

This command queries the results of PM modulation measurement of analog demodulation.

Suffix:

<t> 1...6
trace 1, 2, 3, 4, 5 or 6

<n> 1...4
irrelevant

Parameters:

<Result> The result of the selected measurement type is returned.

Query parameters:

<MeasType> PPEak | MPEak | MIDDLE | RMS

PPEak

Measurement with detector Pluspeak (+PK)

MPEak

Measurement with detector MinusPeak (-PK)

MIDDLE

Averaging \pm PK/2

RMS

RMS measurement

Example:

ADEM ON (see [SENSe:]ADEMod[:STATe] on page 121)
Switches on the analog demodulator.

CALC:FEED 'XTIM:FM:TDOM', see CALCulate<n>:FEED
on page 90

Switches on the FM result display.

CALC:MARK:FUNC:ADEM:PM? PPE

Queries the peak value.

Usage: Query only

Mode: ADEMOD

CALCulate<n>:MARKer:FUNCtion:ADEMod:SINad:RESult<t>?

This command queries the result of the SINAD measurement in the specified window.

Suffix:

<n> 1...4
window

<t> 1...6
trace 1, 2, 3, 4, 5 or 6

Example:	ADEM ON (see [SENSe:]ADEMod[:STATe] on page 121) Switches on analog demodulator CALC:FEED 'XTIM:FM:AFSP', see CALCulate<n>:FEED on page 90 Switches on AF spectrum of FM CALC:MARK:FUNC:ADEM:SIN:RES? Queries SINAD value
Usage:	Query only
Mode:	ADEMOD

CALCulate<n>:MARKer:FUNCTION:ADEMod:THD:RESult<t>?

This command queries the result of the THD measurement in the specified window.

Suffix:

<n>	1...4 window
<t>	1...6 trace 1, 2, 3, 4, 5 or 6

Example:	ADEM ON (see [SENSe:]ADEMod[:STATe] on page 121) Switches on analog demodulator CALC:FEED 'XTIM:FM:AFSP', see CALCulate<n>:FEED on page 90 Switches on AF spectrum of FM DISP:TRAC ON, see DISPlay[:WINDow<n>]:TRACe<t>[: STATe] on page 111 Switches on the trace CALC:MARK:FUNC:ADEM:THD:RES? Queries THD result
Usage:	Query only
Mode:	ADEMOD

2.3.2.2 Other CALCulate commands

CALCulate<n>:FEED <Evaluation>

This command selects the evaluation method of the measured data that is to be displayed in the specified window.

The suffix <1...6> indicates which of the traces is evaluated in the result summary. Note that all result summaries are identical, as the results of all evaluations are included in the summary.

Suffix:

<n> 1...4
window

Parameters:

<Evaluation> XTIM:AM:RELative[:TDOMain] |
XTIM:AM:RELative:AFSPectrum<1...6> |
XTIM:AM[:ABSolute][:TDOMain] | XTIM:RFPower[:TDOMain] |
XTIM:FM[:TDOMain] | XTIM:FM:AFSPectrum<1...6> |
XTIM:PM[:TDOMain] | XTIM:PM:AFSPectrum<1...6> |
XTIM:AMSummary<1...6>[:ABSolute] |
XTIM:AMSummary<1...6>:RELative |
XTIM:FMSummary<1...6> | XTIM:PMSummary<1...6> |
XTIM:SPECTrum | XTIM:SUMMary<1...6> |
XTIM:RFPower[:TDOMain] | XTIM:SPECTrum |
XTIM:SUMMary<1...6> | XFRequency:SFM:LEFT |
XFRequency:SFM:RIGHT | XFRequency:SFM:MPX |
XFRequency:SFM:MONO | XFRequency:SFM:STEReo |
XFRequency:SFM:RDS | XFRequency:SFM:PILot |
XTIMe:SFM:LEFT | XTIMe:SFM:RIGHT | XTIMe:SFM:MPX |
XTIMe:SFM:MONO | XTIMe:SFM:STEReo | XTIMe:SFM:RDS |
XTIMe:SFM:PILot

XTIM:AM:RELative[:TDOMain]

Demodulated AM signal in time domain

XTIM:AM:RELative:AFSPectrum<1...6>

AF spectrum of the demodulated AM signal

XTIM:AM[:ABSolute][:TDOMain]

RF signal in time domain (RF power)

Same as 'XTIM:RFPower'

XTIM:RFPower[:TDOMain]

RF power of the signal (RF signal in time domain)

XTIM:FM[:TDOMain]

Demodulated FM signal in time domain

XTIM:FM:AFSPectrum<1...6>

AF spectrum of the demodulated FM signal

XTIM:PM[:TDOMain]

Demodulated PM signal in time domain

XTIM:PM:AFSPectrum<1...6>

AF spectrum of the demodulated PM signal

XTIM:AMSummary<1...6>[:ABSolute]

Result summary for RF signal

XTIM:AMSummary<1...6>:RELative

Result summary for demodulated AM signal

XTIM:FMSummary<1...6>

Result summary for demodulated FM signal

XTIM:PMSummary<1...6>

Result summary for demodulated PM signal

XTIM:SPECTrum

RF spectrum of the signal determined from the measured data via FFT

XTIM:SUMMArY<1...6>

Summary of all evaluation lists

XFRequency:SFM:LEFt

Left channel spectrum of FM stereo signal

XFRequency:SFM:RIGHt

Right channel spectrum of FM stereo signal

XFRequency:SFM:MPX

MPX channel spectrum of FM stereo signal

XFRequency:SFM:MONO

Mono channel spectrum of FM stereo signal

XFRequency:SFM:STEReo

Stereo channel spectrum of FM stereo signal

XFRequency:SFM:RDS

RDS channel spectrum of FM stereo signal

XFRequency:SFM:PILot

Pilot channel spectrum of FM stereo signal

XTIME:SFM:LEFt

Left channel of FM stereo signal in time domain

XTIME:SFM:RIGHt

Right channel of FM stereo signal in time domain

XTIME:SFM:MPX

MPX channel of FM stereo signal in time domain

XTIME:SFM:MONO

Mono channel of FM stereo signal in time domain

XTIME:SFM:STEReo

Stereo channel of FM stereo signal in time domain

XTIME:SFM:RDS

RDS channel of FM stereo signal in time domain

XTIME:SFM:PILot

Pilot channel of FM stereo signal in time domain

Example:

```
INST:SEL ADEM
```

(see [INSTrument\[:SElect\]](#) on page 116)

Activates analog demodulator.

```
CALC:FEED 'XTIM:FM'
```

Selects the display of the FM signal.

Usage:

SCPI confirmed

Mode:

ADEMODO, SFM

Manual operation: See "AM" on page 28
 See "Screen A-D" on page 28
 See "FM" on page 37
 See "PM" on page 38
 See "RF Power" on page 39
 See "Left" on page 193
 See "Screen A-D" on page 194
 See "Right" on page 205
 See "MPX" on page 205
 See "Mono" on page 205
 See "Stereo" on page 205
 See "RDS" on page 205
 See "Pilot" on page 205
 See "RF Power" on page 205

CALCulate<n>:FORMat <Limitation>

This command activates the limitation to $\pm 180^\circ$.

Suffix:

<n> 1...4
 irrelevant

Parameters:

<Limitation> PHASe | UPHase
PHASe
 Limitation to $\pm 180^\circ$
UPHase
 Unwrapped
 *RST: UPHase

Example:

CALC:FORM PHAS
 Activates the limitation to $\pm 180^\circ$.

Usage:

SCPI confirmed

Mode:

AEMOD

Manual operation: See "Phase Wrap On/Off" on page 39

CALCulate<n>:MARKer<m>:FUNCTION:PNOise:RESult?

This command queries the result of the phase noise measurement at the specified marker in the specified window.

A complete sweep with synchronization to the sweep end must be performed between switching on the function and querying the measured value in order to obtain a correct query result. This is only possible in single sweep mode.

Suffix:

<n> 1...4
 window

<m> 1...16
marker

Example: INIT:CONT OFF
Switches to single sweep mode.
CALC:MARK2 ON
Switches on marker 2.
CALC:MARK2:FUNC:PNO ON
Switches on the phase noise marker 2.
INIT;*WAI
Starts a sweep and waits for the end.
CALC:MARK2:PNO:RES?
Outputs the phase noise result of marker 2.

Usage: Query only

Mode: ADEMODO

Manual operation: See "Phase Noise" on page 72

CALCulate<n>:MARKer<m>:FUNCtion:FPEaks:ANNotation:LABel:STATe <State>

This command turns labels for peaks found during a peak search on and off.

The labels correspond to the marker number in the marker peak list.

Suffix:

<n> Selects the measurement window.

<m> Selects the marker.

Parameters:

<State> **ON | OFF**

*RST: ON

Example: CALC:MARK:FUNC:FPE:ANN:LAB:STAT OFF
Removes the peak labels from the diagram

Manual operation: See "Marker Number" on page 75

CALCulate<n>:MARKer<m>:FUNCtion:FPEaks:LIST:SIZE <MaxNoPeaks>

This command defines the maximum number of peaks the marker peak list may contain.

Suffix:

<n> Selects the measurement window.

<m> Selects the marker.

Parameters:

<MaxNoPeaks> Maximum number of peaks to be determined.

*RST: 50

Example: `CALC:MARK:FUNC:FPE:LIST:SIZE 10`
The marker peak list will contain a maximum of 10 peaks.

Manual operation: See ["Max Peak Count"](#) on page 74

CALCulate<n>:MARKer<m>:FUNCTion:FPEaks:STAT <State>

This command turns a peak search on and off.

Suffix:

<n> Selects the measurement window.

<m> Selects the marker.

Parameters:

<State> ON | OFF

*RST: OFF

Example: `CALC:MARK:FUNC:FPE:STAT ON`
Activates marker peak search

Manual operation: See ["Peak List On/Off"](#) on page 74

CALCulate<n>:MARKer<m>:FUNCTion:PNOise <State>

This command switches the phase noise measurement for the specified marker on or off in the specified window. The phase noise power density is measured at the position of the markers. The result can be queried with `CALCulate<n>:MARKer<m>:FUNCTion:PNOise:RESult?` on page 93.

Suffix:

<n> 1...4
window

<m> 1...16
marker

Parameters:

<State> ON | OFF

*RST: OFF

Example: `CALC:MARK2:FUNC:PNO ON`
Switches on the phase noise marker 2.

Mode: ADEMODO

CALCulate<n>:MARKer<m>:FUNCTion:ZOOM <Range>

This command defines the range to be zoomed around marker 1. Marker 1 is activated first, if necessary.

The subsequent frequency sweep is stopped at the marker position and the frequency of the signal is counted. This frequency becomes the new center frequency, and the zoomed span is set.

Note that you should perform a complete measurement with synchronization to the end of the measurement. This is only possible for single sweeps.

Suffix:

<n> Selects the measurement window.

<m> Selects the marker.

Parameters:

<Range> <numeric_value>

Example:

```
INIT:CONT OFF
```

Switches to single sweep mode

```
CALC:MARK:FUNC:ZOOM 1kHz;*WAI
```

Activates zooming and waits for its end.

Manual operation: See "[Marker Zoom \(span > 0\)](#)" on page 71

CALCulate<n>:MARKer<m>:LINK <DisplayType>

Links the markers in all displays of the specified type.

Suffix:

<n> 1...4
window

<m> 1...16
marker

Parameters:

<DisplayType> TIME | SPECTrum | BOTH | NONE

TIME

Links the markers in all time domain diagrams

SPECTrum

Links the markers in all AF Spectrum displays

BOTH

Links the markers both in the time domain diagrams and in the AF Spectrum displays

NONE

Markers are not linked.

```
*RST: NONE
```

Example:

```
CALC1:MARK1:LINK TIME
```

Links the marker 1 in all time domain diagrams in screen A.

Mode:

ADEM0D

Manual operation:

See "[Link Time Marker](#)" on page 71

See "[Link AF Spectrum Marker](#)" on page 71

CALCulate<n>:THReshold <Threshold>

This command defines a threshold value for the marker peak search.

A threshold line is automatically turned on.

Suffix:

<n> irrelevant

Parameters:

<Threshold> The unit depends on `CALCulate<n>:UNIT:POWer`.

*RST: (STATe to OFF)

Example:

`CALC:THR -82DBM`

Sets the threshold value to -82 dBm.

Manual operation: See "[Threshold](#)" on page 75

CALCulate<n>:THReshold:STATe <State>

This command turns the threshold line for the marker peak search on and off.

Suffix:

<n> irrelevant

Parameters:

<State> ON | OFF

*RST: OFF

Example:

`CALC:THR:STAT ON`

Switches on the threshold line.

Manual operation: See "[Threshold](#)" on page 75

CALCulate<n>:UNIT:ANGLe <Unit>

This command selects the unit for angles.

The unit is defined globally for all windows.

Suffix:

<n> irrelevant

Parameters:

<Unit> DEG | RAD

*RST: RAD

Example:

`CALC:UNIT:ANGL DEG`

Mode:

AEMOD

CALCulate<n>:UNIT:POWer <Unit>

This command selects the unit of the y-axis.

The unit applies to all measurement windows.

Suffix:

<n> irrelevant

Parameters:

<Unit> DBM | V | A | W | DBPW | WATT | DBUV | DBMV | VOLT |
 DBUA | AMPere
 *RST: dBm

Example:

CALC:UNIT:POW DBM
 Sets the power unit to dBm.

CALC:UNIT:THD <Mode>

Selects the unit for THD measurements.

Parameters:

<Mode> DB | PCT
 *RST: DB

Example:

CALC:UNIT:THD PCT

Mode:

AEMOD, SFM

2.3.2.3 Other Referenced CALCulate Commands**CALCulate<n>:MARKer<m>:AOFF**

This command all markers off, including delta markers and marker measurement functions.

Suffix:

<n> Selects the measurement window.
 <m> depends on mode
 irrelevant

Example:

CALC:MARK:AOFF
 Switches off all markers.

Usage:

Event

Manual operation: See "[All Marker Off](#)" on page 69

CALCulate<n>:MARKer<m>:FUNCTION:FPEaks:COUNT?

This command queries the number of peaks that have been found during a peak search.

Suffix:

<n> irrelevant
 <m> Selects the marker.

Return values:

<NumberOfPeaks>

Example: `CALC:MARK:FUNC:FPE 3`
 Searches the 3 highest maxima for trace 1
`CALC:MARK:FUNC:FPE:COUN?`
 Queries the number of maxima found

Usage: Query only

Manual operation: See "[Marker Peak List](#)" on page 74

CALCulate<n>:MARKer<m>:FUNction:FPEaks:SORT <SortMode>

This command selects the order in which the results of a peak search are returned.

Suffix:

<n> Selects the measurement window.

<m> Selects the marker.

Parameters:

<SortMode> **X**
 Sorts the peaks according to increasing position on the x-axis.
Y
 Sorts the peaks according to decreasing position on the y-axis.

Example: `CALC:MARK:FUNC:FPE:SORT Y`
 Sets the sort mode to decreasing y values

Manual operation: See "[Sort Mode Freq/Lvl](#)" on page 74

CALCulate<n>:MARKer<m>:FUNction:FPEaks:X

This command queries the position of the peaks on the x-axis.

The order depends on the sort order that has been set with `CALCulate<n>:MARKer<m>:FUNction:FPEaks:SORT` on page 99.

The number of peaks on the number that has been set with `CALCulate<n>:MARKer<m>:FUNction:FPEaks:COUNt?`.

Suffix:

<n> Selects the measurement window.

<m> Selects the marker.

Return values:

<PeakPosition> Position of the peaks on the x-axis. The unit depends on the measurement.

Example:

```

CALC:MARK:FUNC:FPE:SORT Y
Sets the sort mode to decreasing y values
CALC:MARK:FUNC:FPE 3
Searches the 3 highest maxima for trace 1
CALC:MARK:FUNC:FPE:COUN?
Queries the number of maxima found
CALC:MARK:FUNC:FPE:X?
Queries the frequencies (span <> 0) or. time (span = 0) of the
maxima found
107.5E6,153.8E6,187.9E6
frequencies in increasing order
2.05E-3,2.37E-3, 3.71e-3
times in increasing order

```

Manual operation: See "[Marker Peak List](#)" on page 74

CALCulate<n>:MARKer<m>:FUNCTion:FPEaks:Y?

This command queries the position of the peaks on the y-axis.

The order depends on the sort order that has been set with [CALCulate<n>:MARKer<m>:FUNCTion:FPEaks:SORT](#) on page 99.

The number of peaks on the number that has been set with [CALCulate<n>:MARKer<m>:FUNCTion:FPEaks:COUNT?](#).

Suffix:

<n> Selects the measurement window.
 <m> Selects the marker.

Return values:

<PeakPosition> Position of the peaks on the y-axis. The unit depends on the measurement.

Example:

```

CALC:MARK:FUNC:FPE:SORT Y
Sets the sort mode to decreasing y values
CALC:MARK:FUNC:FPE 3
Searches the 3 highest maxima for trace 1
CALC:MARK:FUNC:FPE:COUN?
Queries the number of maxima found
CALC:MARK:FUNC:FPE:Y?
Queries the levels of the maxima found

```

Usage: Query only

Manual operation: See "[Marker Peak List](#)" on page 74

CALCulate<n>:MARKer<m>:FUNCTion:NDBDown <Distance>

This command defines the distance of the n dB down markers to the reference marker.

The temporary markers T1 and T2 are positioned n dB below the active reference marker. The frequency and time position of these markers can be queried with `CALCulate<n>:MARKer<m>:FUNction:NDBDown:FREQuency?` and `CALCulate<n>:MARKer<m>:FUNction:NDBDown:TIME?`. The bandwidth between the markers can be queried with `CALCulate<n>:MARKer<m>:FUNction:NDBDown:RESult?`.

Suffix:

<n> Selects the measurement window.
 <m> irrelevant

Parameters:

<Distance> Distance of the temporary markers to the reference marker in dB.
 *RST: 6dB

Example:

```
CALC:MARK:FUNC:NDBD 3dB
Sets the level spacing to 3 dB.
```

Manual operation: See "[n dB down](#)" on page 73

CALCulate<n>:MARKer<m>:FUNction:NDBDown:FREQuency?

This command queries the position of the n dB down markers on the x-axis when measuring in the frequency domain.

To get a valid result, you have to perform a complete measurement with synchronization to the end of the measurement before reading out the result. This is only possible for single sweeps.

Suffix:

<n> Selects the measurement window.
 <m> irrelevant

Return values:

<Frequency> **<frequency 1>**
 absolute frequency of the n dB marker to the left of the reference marker in Hz
<frequency 2>
 absolute frequency of the n dB marker to the right of the reference marker in Hz

Example:

```
INIT:CONT OFF
Switches to single sweep mode.
CALC:MARK:FUNC:NDBD ON
Switches on the n dB down function.
INIT;*WAI
Starts a sweep and waits for the end.
CALC:MARK:FUNC:NDBD:FREQ?
Outputs the frequencies of the temporary markers.
```

Usage: Query only

Manual operation: See "n dB down" on page 73

CALCulate<n>:MARKer<m>:FUNCtion:NDBDown:QFACtor

This command queries the Q factor (quality) of n dB down measurements.

Suffix:

<n> Selects the measurement window.

<m> Selects the marker.

Example:

```
INIT:CONT OFF
```

Switches to single sweep mode.

```
CALC:MARK:FUNC:NDBD ON
```

Switches on the n dB down function.

```
INIT;*WAI
```

Starts a sweep and waits for the end.

```
CALC:MARK:FUNC:NDBD:QFAC?
```

Queries the Q factor of the measured bandwidth.

Manual operation: See "n dB down" on page 73

CALCulate<n>:MARKer<m>:FUNCtion:NDBDown:RESult?

This command queries the distance of the n dB down markers from each other.

To get a valid result, you have to perform a complete measurement with synchronization to the end of the measurement before reading out the result. This is only possible for single sweeps.

Suffix:

<n> Selects the measurement window.

<m> irrelevant

Parameters:

<Distance> The result depends on the span.
In case of frequency domain measurements, the command returns the bandwidth between the two n dB down markers in Hz. In case of time domain measurements, the command returns the pulse width between the two n dB down markers in seconds.

Example:

```
INIT:CONT OFF
```

Switches to single sweep mode.

```
CALC:MARK:FUNC:NDBD ON
```

Switches on the n dB down function.

```
INIT;*WAI
```

Starts a sweep and waits for the end.

```
CALC:MARK:FUNC:NDBD:RES?
```

Outputs the measured value.

Usage: Query only

Manual operation: See "n dB down" on page 73

CALCulate<n>:MARKer<m>:FUNCtion:NDBDown:STATe <State>

This command turns the n dB Down marker function on and off.

Suffix:

<n> Selects the measurement window.

<m> irrelevant

Parameters:

<State> ON | OFF

*RST: OFF

Example:

CALC:MARK:FUNC:NDBD:STAT ON

Switches on the "N dB Down" function.

Manual operation: See "n dB down" on page 73

CALCulate<n>:MARKer<m>:FUNCtion:NDBDown:TIME?

This command queries the position of the n dB down markers on the x-axis when measuring in the time domain.

To get a valid result, you have to perform a complete measurement with synchronization to the end of the measurement before reading out the result. This is only possible for single sweeps.

Suffix:

<n> Selects the measurement window.

<m> irrelevant

Return values:

<Time> **<time 1>**

absolute position in time of the n dB marker to the left of the reference marker in seconds

<time 2>

absolute position in time of the n dB marker to the right of the reference marker in seconds

Example:

INIT:CONT OFF

Switches to single sweep mode

CALC:MARK:FUNC:NDBD ON

Switches on the n dB down function.

INIT;*WAI

Starts a sweep and waits for the end.

CALC:MARK:FUNC:NDBD:TIME?

Outputs the time values of the temporary markers.

Usage: Query only

Manual operation: See "n dB down" on page 73

CALCulate<n>:MARKer<m>:PEXCursion <Excursion>

This command defines the peak excursion

The peak excursion sets the requirements for a peak to be detected during a peak search.

The unit depends on the selected operating mode and measurement.

Mode/Display mode	Unit
Spectrum	dB
ADEMODO, RF display	dB
ADEMODO, AM display	PCT
ADEMODO, FM display	kHz
ADEMODO, PM display	RAD

Suffix:

<n> Selects the measurement window.
 <m> irrelevant

Parameters:

<Excursion> The peak excursion is the distance to a trace maximum that must be attained before a new maximum is recognized, or the distance to a trace minimum that must be attained before a new minimum is recognized
 *RST: 6dB in "Spectrum" mode and RF displays; 5 PCT in AM displays, 50 kHz in FM displays, (0.5 RAD in PM displays)

Example:

CALC:MARK:PEXC 10dB
 Defines peak excursion 10 dB.

Manual operation: See "[Peak Excursion](#)" on page 74

CALCulate<n>:MARKer<m>[:STATe] <State>

This command turns markers on and off.

If the corresponding marker number is currently active as a deltamarker, it is turned into a normal marker.

Suffix:

<n> Selects the measurement window.
 <m> depends on mode
 Selects the marker.

Parameters:

<State> ON | OFF
 *RST: OFF

Example: `CALC:MARK3 ON`
Switches on marker 3 or switches to marker mode.

Manual operation: See "[Marker 1 / Marker 2 / Marker 3 / ... Marker 16, / Marker Norm/Delta](#)" on page 68
See "[Marker Wizard](#)" on page 68

CALCulate<n>:MARKer<m>:TRACe <Trace>

This command selects the trace a marker is positioned on.

The corresponding trace must have a trace mode other than "Blank".

If necessary, the corresponding marker is switched on prior to the assignment.

Suffix:

<n> Selects the measurement window.

<m> depends on mode
Selects the marker.

Parameters:

<Trace> **1 ... 6**
Trace number the marker is positioned on.

Example: `CALC:MARK3:TRAC 2`
Assigns marker 3 to trace 2.

Manual operation: See "[Marker to Trace](#)" on page 68
See "[Marker Wizard](#)" on page 68

CALCulate<n>:MARKer<m>:X <Position>

This command positions a marker on a particular coordinate on the x-axis.

If marker 2, 3 or 4 is selected and used as delta marker, it is switched to marker mode.

Suffix:

<n> Selects the measurement window.

<m> Selects the marker.

Parameters:

<Position> Numeric value that defines the marker position on the x-axis.
The unit is either Hz (frequency domain) or s (time domain) or dB (statistics).

Range: The range depends on the current x-axis range.

Example: `CALC:MARK2:X 1.7MHz`
Positions marker 2 to frequency 1.7 MHz.

Manual operation: See "[Marker 1 / Marker 2 / Marker 3 / ... Marker 16, / Marker Norm/Delta](#)" on page 68

CALCulate<n>:MARKer<m>:X:SLIMits:LEFT <Limit>

This command sets the left limit of the marker search range.

If the power measurement in zero span is active, this command limits the evaluation range to the trace.

Note: The function is only available if the search limit for marker and delta marker is switched on (see `CALCulate<n>:MARKer<m>:X:SLIMits[:STATe]`).

Suffix:

<n> Selects the measurement window.
 <m> irrelevant

Parameters:

<Limit> The value range depends on the span or sweep time.
 The unit is Hz for frequency domain measurements and s for
 time domain measurements.

Range: 0 to MAX
 *RST: left diagram border

Example:

`CALC:MARK:X:SLIM ON`
 Switches the search limit function on.
`CALC:MARK:X:SLIM:LEFT 10MHz`
 Sets the left limit of the search range to 10 MHz.

Manual operation: See "[Left Limit](#)" on page 74

CALCulate<n>:MARKer<m>:X:SLIMits:RIGHT <Limit>

This command sets the right limit of the marker search range.

If the power measurement in zero span is active, this command limits the evaluation range to the trace.

Note: The function is only available if the search limit for marker and delta marker is switched on (`CALCulate<n>:MARKer<m>:X:SLIMits[:STATe]`).

Suffix:

<n> Selects the measurement window.
 <m> irrelevant

Parameters:

<Limit> The value range depends on the span or sweep time.
 The unit is Hz for frequency domain measurements and s for
 time domain measurements.

Range: 0 to MAX
 *RST: left diagram border

Example:

`CALC:MARK:X:SLIM ON`
 Switches the search limit function on.
`CALC:MARK:X:SLIM:RIGH 20MHz`
 Sets the right limit of the search range to 20 MHz.

Manual operation: See ["Right Limit"](#) on page 75

CALCulate<n>:MARKer<m>:X:SLIMits[:STATe] <State>

This command turns marker search limits on and off.

If the power measurement in zero span is active, this command limits the evaluation range on the trace.

Suffix:

<n> Selects the measurement window.

<m> marker

Parameters:

<State> ON | OFF

*RST: OFF

Example:

CALC:MARK:X:SLIM ON
Switches on search limitation.

CALCulate<n>:MARKer<m>:X:SSIZe <StepSize>

This command defines the step size of the rotary knob for marker or delta marker value changes. It only takes effect in manual operation.

The marker step size is unavailable for statistical measurements.

Suffix:

<n> irrelevant

<m> irrelevant

Parameters:

<StepSize>

STANDARD

step size corresponds to space between two pixels

POINTS

step size corresponds to space between two measured values (number of measured values is defined via the

[SENSe<n>:]SWEep:POINTs command, see [SENSe:]SWEep:POINTs on page 157)

*RST: POINTs

Example:

CALC:MARK:X:SSIZ STAN
Sets the measured value step size.

Manual operation: See ["Stepsize Standard"](#) on page 70
See ["Stepsize Sweep Points"](#) on page 70

CALCulate<n>:MARKer<m>:Y?

This command queries the measured value of a marker.

The corresponding marker is activated before or switched to marker mode, if necessary.

To get a valid result, you have to perform a complete measurement with synchronization to the end of the measurement before reading out the result. This is only possible for single sweeps.

If the analog demodulator (option Analog Demodulation, R&S FSV-K7) is activated, the query result is output in the following units:

Result display	Output unit
AM	%
FM	Hz
PM	rad/deg (defined with <code>CALCulate<n>:UNIT:ANGLE</code> on page 97)
RF	dB (Range Log or Range Linear %) % (Range Linear dB)

Suffix:

<n> Selects the measurement window.
<m> Selects the marker.

Return values:

<Result> The measured value of the selected marker is returned.

Example:

```
INIT:CONT OFF
Switches to single sweep mode.
CALC:MARK2 ON
Switches marker 2.
INIT;*WAI
Starts a sweep and waits for the end.
CALC:MARK2:Y?
Outputs the measured value of marker 2.
```

Usage: Query only

Manual operation: See "Marker 1 / Marker 2 / Marker 3 / ... Marker 16, / Marker Norm/Delta" on page 68

2.3.3 DISPlay Subsystem (Analog Demodulation, R&S FSV-K7)

The DISPLay subsystem controls the selection and presentation of textual and graphic information as well as of measurement data on the display.

<code>DISPlay:MTABLE</code>	109
<code>DISPlay[:WINDow<n>]:STATe</code>	109
<code>DISPlay[:WINDow<n>][:SUBWindow<1 2>]:SElect</code>	109
<code>DISPlay[:WINDow<n>]:SSElect?</code>	110
<code>DISPlay[:WINDow<n>]:TRACe<t>:MODE</code>	110
<code>DISPlay[:WINDow<n>]:TRACe<t>[:STATe]</code>	111
<code>DISPlay[:WINDow<n>]:TRACe<t>:Y[:SCALE]</code>	111

DISPlay[:WINDow<n>]:TRACe<t>:Y[:SCALe]:MODE.....	112
DISPlay[:WINDow<n>]:TRACe<t>:Y[:SCALe]:PDIVision.....	112
DISPlay[:WINDow<n>]:TRACe<t>:Y[:SCALe]:RLEVel.....	113
DISPlay[:WINDow<n>]:TRACe<t>:Y[:SCALe]:RLEVel:OFFSet.....	113
DISPlay[:WINDow<n>]:TRACe<t>:Y[:SCALe]:RPOSition.....	113
DISPlay[:WINDow<n>]:TRACe<t>:Y[:SCALe]:RVALue.....	114
DISPlay[:WINDow<n>]:TRACe<t>:Y:SPACing.....	114
DISPlay:WSElect?.....	115

DISPlay:MTABLE <DisplayMode>

This command turns the marker table on and off.

Parameters:

<DisplayMode>	ON Marker table is displayed.
	OFF Marker table is not displayed.
	AUTO Marker table is only displayed if 2 or more markers are active.
	*RST: AUTO

Example: To activate the table display:
 DISP:MTAB ON
 To query the current state of the marker table display:
 DISP:MTAB?

Manual operation: See "[Marker Table](#)" on page 70

DISPlay[:WINDow<n>]:STATe <State>

This command activates the measurement specified window.

Suffix:

<n>	1...4 window
-----	-----------------

Parameters:

<State>	ON OFF
---------	----------

Example: DISP:WIND2:STAT ON
 Displays a second window (Screen B).

Usage: SCPI confirmed

Mode: ADEMODO

Manual operation: See "[Screen A-D](#)" on page 28

DISPlay[:WINDow<n>][:SUBWindow<1|2>]:SELEct

Moves the focus area to the selected window and subwindow.

Suffix:	
<n>	1 window
Example:	<pre>DISP:WIND2:STAT ON</pre> <p>Displays a second window (Screen B).</p> <pre>CALC2:FEED 'XTIME:FM:AFSPektrum1'</pre> <p>Displays an AF spectrum diagram of the demodulated FM signal from trace 1 in screen B.</p> <pre>DISP:WIND2:SEL</pre> <p>Switches the focus area to the evaluation list of the AF spectrum diagram in screen B.</p>
Usage:	SCPI confirmed
Mode:	ADEMODO

DISPlay[:WINDow<n>]:SSElect?

Queries the currently selected subwindow.

Suffix:	
<n>	1...4 window
Return values:	
<Result>	1 2 1 Diagram 2 Result list
Example:	<pre>DISP:WIND2:SUBW2:SEL</pre> <p>Switches the focus area to the result list in screen B.</p> <pre>DISP:WIND2:SSEL?</pre> <p>Result: 2</p>
Usage:	Query only SCPI confirmed
Mode:	ADEMODO

DISPlay[:WINDow<n>]:TRACe<t>:MODE <Mode>

This command defines the type of display and the evaluation of the traces. WRITE corresponds to the Clr/Write mode of manual operation. The trace is switched off (= BLANK in manual operation) with `DISPlay[:WINDow<n>]:TRACe<t>[:STATe]`.

The number of measurements for AVERage, MAXHold and MINHold is defined with the `[SENSe:]AVERage<n>:COUNT` or `[SENSe:]SWEep:COUNT` commands. It should be noted that synchronization to the end of the indicated number of measurements is only possible in single sweep mode.

Suffix:

<n> window; For applications that do not have more than 1 measurement window, the suffix <n> is irrelevant.

<t> trace

Parameters:

<Mode> WRITe | VIEW | AVERAge | MAXHold | MINHold | BLANK

*RST: WRITe for TRACe1, STATe OFF for
TRACe2/3/4/5/6

For details on trace modes refer to [Chapter 2.1.7, "Trace Mode Overview"](#), on page 17.

Example:

```
INIT:CONT OFF
```

Switching to single sweep mode.

```
SWE:COUN 16
```

Sets the number of measurements to 16.

```
DISP:TRAC3:MODE MAXH
```

Switches on the calculation of the maximum peak for trace 3.

```
INIT;*WAI
```

Starts the measurement and waits for the end of the 16 sweeps.

Manual operation: See ["Clear Write"](#) on page 17

See ["Max Hold"](#) on page 18

See ["Min Hold"](#) on page 18

See ["Average"](#) on page 18

See ["View"](#) on page 18

DISPlay[:WINDow<n>]:TRACe<t>[:STATe] <State>

This command switches on or off the display of the corresponding trace. The other measurements are not aborted but continue running in the background.

Suffix:

<n> window; For applications that do not have more than 1 measurement window, the suffix <n> is irrelevant.

<t> trace

Parameters:

<State> ON | OFF

*RST: ON for TRACe1, OFF for TRACe2 to 6

Example:

```
DISP:TRAC3 ON
```

Manual operation: See ["Blank"](#) on page 19

DISPlay[:WINDow<n>]:TRACe<t>:Y[:SCALe] <Range>

This command defines the display range of the y-axis with logarithmic scaling.

The command works only for a logarithmic scaling. You can select the scaling with [DISPlay\[:WINDow<n>\]:TRACe<t>:Y:SPACing](#) on page 114.

Remote Commands of the Analog Demodulation (R&S FSV-K7)

Suffix:

<n> window; For applications that do not have more than 1 measurement window, the suffix <n> is irrelevant.

<t> irrelevant

Parameters:

<Range> Range: 10 to 200
*RST: 100
Default unit: dB

Example: DISP:TRAC:Y 110dB

Manual operation: See "Range Log 100 dB" on page 44
See "Range Log 50 dB" on page 44
See "Range Log 10 dB" on page 45
See "Range Log 5 dB" on page 45
See "Range Log 1 dB" on page 45
See "Range Log Manual" on page 45

DISPlay[:WINDow<n>]:TRACe<t>:Y[:SCALe]:MODE <Mode>

This command selects the type of scaling of the y-axis.

When `SYSTem:DISPlay:UPDate` is turned off, this command has no immediate effect on the screen.

Suffix:

<n> window; For applications that do not have more than 1 measurement window, the suffix <n> is irrelevant.

<t> irrelevant

Parameters:

<Mode> **ABSolute**
absolute scaling of the y-axis
RELative
relative scaling of the y-axis
*RST: ABS

Example: DISP:TRAC:Y:MODE REL

Manual operation: See "Grid Abs/Rel " on page 48

DISPlay[:WINDow<n>]:TRACe<t>:Y[:SCALe]:PDIVision <Distance>

This command defines the distance between two grid lines of the y-axis in the current unit.

Suffix:

<n> irrelevant

<t> irrelevant

Parameters:

<Distance> <numeric value>
 *RST: 20 PCT = linear AM display, (50 kHz = linear FM display), (2 rad = linear PM display), (10 dB = logarithmic AF spectrum display)

Example:

DISP:TRAC:Y:PDIV +10kHz
 Sets the Y scale to 10 kHz per division.

Mode: ADEMODO

Manual operation: See "[Dev per Division](#)" on page 34

DISPlay[:WINDow<n>]:TRACe<t>:Y[:SCALe]:RLEVel <ReferenceLevel>

This command defines the reference level.

With the reference level offset $\neq 0$, the value range of the reference level is modified by the offset.

Suffix:

<n> irrelevant.

<t> irrelevant

Parameters:

<ReferenceLevel> The unit is variable.
 Range: see datasheet
 *RST: -10dBm

Example:

DISP:TRAC:Y:RLEV -60dBm

Manual operation: See "[Ref Level](#)" on page 44

DISPlay[:WINDow<n>]:TRACe<t>:Y[:SCALe]:RLEVel:OFFSet <Value>

This command defines a reference level offset.

Suffix:

<n> irrelevant.

<t> irrelevant

Parameters:

<Value> Range: -200 to 200
 *RST: 0
 Default unit: dB

Example:

DISP:TRAC:Y:RLEV:OFFS -10dB

Manual operation: See "[Ref Level Offset](#)" on page 48

DISPlay[:WINDow<n>]:TRACe<t>:Y[:SCALe]:RPOsition <Position>

This command defines the position of the reference level on the display grid..

When using a tracking generator (only with option R&S FSV-B9 or -B10, requires active normalization), and in Bluetooth mode (option R&S FSV-K8) this command defines the position of the reference value for all windows.

Suffix:

<n> Selects the measurement window.
 <t> irrelevant

Parameters:

<Position> 0 PCT corresponds to the lower display border, 100% corresponds to the upper display border.
 Range: 0 to 100
 *RST: Spectrum mode: 100 PCT, with tracking generator or time display: 50 PCT
 Default unit: PCT

Example:

DISP:TRAC:Y:RPOS 50PCT

Manual operation: See "[Reference Position](#)" on page 34
 See "[Ref Level Position](#)" on page 48

DISPlay[:WINDow<n>]:TRACe<t>:Y[:SCALe]:RVALue <Value>

This command defines the reference value assigned to the reference position in the specified window. Separate reference values are maintained for the various displays.

Suffix:

<n> 1...4
 window
 <t> irrelevant

Parameters:

<Value> *RST: 0 PCT = AM display, (0 Hz = FM display), (0 rad = PM display), (100 PCT = AF spectrum display of AM signal), (250 kHz = AF spectrum display of FM signal), (10 rad = AF spectrum display of PM signal)

Example:

DISP:TRAC:Y:RVAL 0

Sets the value assigned to the reference position to 0 Hz (analog demodulation)

Manual operation: See "[Reference Value](#)" on page 34

DISPlay[:WINDow<n>]:TRACe<t>:Y:SPACing <ScalingType>

This command selects the scaling of the y-axis.

For AF spectrum displays, only the parameters "LINear" and "LOGarithmic" are permitted.

Suffix:

<n> Selects the measurement window.

<t>	irrelevant
Parameters:	
<ScalingType>	LOGarithmic Logarithmic scaling.
	LINear Linear scaling in %.
	LDB Linear scaling in dB.
	*RST: LOGarithmic
Example:	DISP:TRAC:Y:SPAC LIN Select a linear scale.
Manual operation:	See "Deviation Lin/Log" on page 35 See "Range Log 100 dB" on page 44 See "Range Log 50 dB" on page 44 See "Range Log 10 dB" on page 45 See "Range Log 5 dB" on page 45 See "Range Log 1 dB" on page 45 See "Range Log Manual" on page 45 See "Range Linear %" on page 45 See "Range Lin. Unit" on page 46

DISPlay:WSElect?

Queries the currently selected window.

Example: DISP:WIND2:SEL
Switches the focus area to screen B.
DISP:WSEL?
Result: 2

Usage: Query only
SCPI confirmed

Mode: ADEMODO

2.3.4 INSTRUMENT Subsystem (Analog Demodulation, R&S FSV-K7)

The INSTRUMENT subsystem selects the operating mode of the unit either via text parameters or fixed numbers.

INSTRUMENT[:SElect].....	116
INSTRUMENT:NSElect <Mode>.....	116

INSTRument[:SElect] <Mode>

Selects the instrument mode.

Parameters:

<Mode>	ADEMod Analog Demodulation option, R&S FSV-K7
	SFM FM Stereo option, R&S FSV-K7S

Mode: ADEMOD, SFM

Manual operation: See "Screen A-D" on page 194

INSTRument:NSElect <Mode> <Mode>

Selects the instrument mode.

Parameters:

<Mode>	3 Analog Demodulation option, R&S FSV-K7
	7 FM Stereo option, R&S FSV-K7S

Mode: ADEMOD, SFM

2.3.5 PROBE subsystem

With firmware R&S FSVA/FSV 1.61SP2 or newer, active probes are supported (via an adapter). The following commands activate and configure a connected probe which is to provide an input signal. They are only available if a probe is connected to the instrument's [RF Input] and USB connectors.

For details see the base unit description.

PROBe:ID:PARTnumber?

This command returns the material part number of the connected probe.

Example: PROB:ID:PART?

Usage: Query only

PROBe:ID:SRNumber?

This command returns the serial number of the connected probe.

Example: PROB:ID:SRN?

Usage: Query only

PROBe:SETup:MODE <Mode>

This command defines which action is taken when the probe's micro button is pressed.

Parameters:

<Mode>	RSINgLe
	A single sweep is performed.
	NOACtion
	No action is taken.
	*RST: OFF

Example: `PROB:SET:STAT ON`

Manual operation: See "[Probe Config](#)" on page 77

PROBe:SETup:NAME?

This command returns the name of the connected probe.

Example: `PROB:SET:NAME?`

Usage: Query only

PROBe:SETup:STATe?

This command queries whether a probe is connected to the instrument's [RF Input] and USB connectors and was recognized by the R&S FSVA/FSV.

Example: `PROB:SET:STAT ON`

Usage: Query only

PROBe[:STATe] <State>

This command activates a connected probe. Use this command to switch off the probe and measure the digital input without considering the transducer factor of the probe.

Parameters:

<State>	ON OFF
	*RST: OFF

Example: `PROB:STAT ON`

Manual operation: See "[Probe Config](#)" on page 77

2.3.6 SENSE Subsystem (Analog Demodulation, R&S FSV-K7)

The SENSE subsystem is organized in several subsystems. The commands of these subsystems directly control device-specific settings, they do not refer to the signal characteristics of the measurement signal.

The SENSE subsystem controls the essential parameters of the analyzer. In accordance with the SCPI standard, the keyword "SENSE" is optional for this reason, which means that it is not necessary to include the SENSE node in command sequences.

The following subsystems are included:

2.3.6.1	Trace Mode Result Types.....	118
2.3.6.2	Formats for Returned Values: ASCII Format and Binary Format.....	118
2.3.6.3	SENSE:ADEMod Subsystem (Analog Demodulation, Analog Demodulation).....	119
2.3.6.4	SENSE:ADJust Subsystem.....	145
2.3.6.5	SENSE:BANDwidth Subsystem (Analog Demodulation, R&S FSV-K7).....	147
2.3.6.6	SENSE:FILTer Subsystem (Analog Demodulation, Analog Demodulation).....	148
2.3.6.7	SENSE:FREQUency Subsystem (Analog Demodulation, R&S FSV-K7).....	153
2.3.6.8	SENSE:SWEep Subsystem (Analog Demodulation, R&S FSV-K7).....	155
2.3.6.9	Other commands in the SENSE subsystem.....	157

2.3.6.1 Trace Mode Result Types

The following result types can be set:

WRITE	The current trace results will be obtained
AVERage	The trace results will be averaged over the given # of measurements
MAXHold	The maximum trace result values will be obtained over the given # of measurements
MINHold	The minimum trace result values will be obtained over the given # of measurements
VIEW	The trace results are frozen and displayed, i.e. they are not calculated for subsequent measurements. Traces in this mode cannot be queried.
OFF	The result type will not be used.



It is not possible to query trace data when result type VIEW is selected.

Each value besides OFF can only be assigned to one result type at a time.

If all result types are set to OFF, the AM, FM, or PM demodulator will be deactivated.

2.3.6.2 Formats for Returned Values: ASCII Format and Binary Format

- ASCII Format (FORMat ASCII):
The command reads out a list of comma separated values (CSV) of the measured values in floating point format.
- Binary Format (FORMat REAL,32):
The command reads out binary data (Definite Length Block Data according to IEEE 488.2), each measurement value being formatted in 32 Bit IEEE 754 Floating-Point-Format. The schematics of the result string will be as follows:
#41024<value1><value2>...<value n> with

#4	number of digits (= 4 in the example) of the following number of data bytes
1024	number of following data bytes (= 1024 in the example)
<value>	4-byte floating point value

2.3.6.3 SENSE:ADEMod Subsystem (Analog Demodulation, Analog Demodulation)

The SENSE:ADEMod Subsystem contains commands to set up the instrument for the measurement of analog demodulated signals and query the result at the end of the measurement.

Further information

- Chapter 2.3.6.1, "Trace Mode Result Types", on page 118
- Chapter 2.3.6.2, "Formats for Returned Values: ASCII Format and Binary Format", on page 118

[SENSe:]ADEMod:CAPTure:DOFFset.....	120
[SENSe:]ADEMod:CAPTure:TIME.....	120
[SENSe:]ADEMod:CAPTure[:MODE].....	121
[SENSe:]ADEMod[:STATe].....	121
[SENSe:]ADEMod<n>:AF:CENTer.....	121
[SENSe:]ADEMod<n>:AF:COUPling.....	122
[SENSe:]ADEMod<n>:AF:SPAN.....	122
[SENSe:]ADEMod<n>:AF:SPAN:FULL.....	123
[SENSe:]ADEMod<n>:AF:STARt.....	123
[SENSe:]ADEMod<n>:AF:STOP.....	124
[SENSe:]ADEMod:AM[:ABSolute][:TDOMain]:RESult?	125
[SENSe:]ADEMod:AM[:ABSolute][:TDOMain][:TYPE].....	125
[SENSe:]ADEMod:AM:RELative[:TDOMain][:TYPE].....	126
[SENSe:]ADEMod:AM:RELative[:TDOMain]:RESult?	126
[SENSe:]ADEMod:AM:RELative:AFSPectrum[:TYPE].....	127
[SENSe:]ADEMod:AM:RELative:AFSPectrum:RESult?	128
[SENSe:]ADEMod:BANDwidth BWIDth:DEModulation.....	129
[SENSe:]ADEMod:BANDwidth BWIDth:DEModulation:TYPE.....	129
[SENSe:]ADEMod:FM[:TDOMain][:TYPE].....	129
[SENSe:]ADEMod:FM[:TDOMain]:RESult.....	130
[SENSe:]ADEMod:FM:AFSPectrum[:TYPE].....	131
[SENSe:]ADEMod:FM:AFSPectrum:RESult.....	131
[SENSe:]ADEMod:FM:OFFSet.....	132
[SENSe:]ADEMod:MTIME.....	133
[SENSe:]ADEMod:PM[:TDOMain][:TYPE].....	134
[SENSe:]ADEMod:PM[:TDOMain]:RESult.....	134
[SENSe:]ADEMod:PM:AFSPectrum[:TYPE].....	135
[SENSe:]ADEMod:PM:AFSPectrum:RESult.....	136
[SENSe:]ADEMod:PM:RPOint[:X].....	137
[SENSe:]ADEMod:RELEnGth?.....	138
[SENSe:]ADEMod:SET.....	138
[SENSe:]ADEMod:SPECtrum[:TYPE].....	139

[SENSe:]ADEMod:SPECTrum:BANDwidth BWIDth[:RESolution].....	140
[SENSe:]ADEMod:SPECTrum:RESult.....	140
[SENSe:]ADEMod:SPECTrum:SPAN[:MAXimum].....	141
[SENSe:]ADEMod:SPECTrum:SPAN:ZOOM.....	142
[SENSe:]ADEMod:SQUelch[:STATe].....	142
[SENSe:]ADEMod:SQUelch:LEVel.....	142
[SENSe:]ADEMod:SRATe?.....	143
[SENSe:]ADEMod<n>:ZOOM[:STATe].....	143
[SENSe:]ADEMod<n>:ZOOM:STARt.....	144
[SENSe:]ADEMod<n>:ZOOM:LENGth.....	144
[SENSe:]ADEMod<n>:ZOOM:LENGth:MODE.....	145

[SENSe:]ADEMod:CAPTure:DOFFset <Time>

This command defines an offset of the defined measurement time from the beginning of the capture buffer for analog demodulation if [SENSe:]ADEMod:CAPTure[:MODE] is set to manual mode.

All results are recalculated automatically based on the new data.

Parameters:

<Time> *RST: 0

Example:

ADEM:CAPT MAN

Activates the manual capture buffer processing mode.

ADEM:CAPT:TIME 500 us

Sets the size of the capture buffer to 500 us.

ADEM:CAPT:DOFF 10us

Results are recalculated for the data in the capture buffer starting at 10us.

Mode: ADEMOD

Manual operation: See "Demod Offset" on page 57

[SENSe:]ADEMod:CAPTure:TIME <Time>

This command defines the size of the capture buffer for analog demodulation if [SENSe:]ADEMod:CAPTure[:MODE] is set to manual mode.

Parameters:

<Time> Range: 0 to 7.5 MSamples (time depends on DBW)

*RST: 62.5us

Example:

ADEM:CAPT MAN

Activates the manual capture buffer processing mode.

ADEM:CAPT:TIME 500 us

Mode: ADEMOD

Manual operation: See "Capture Time" on page 57

[SENSe:]ADEMod:CAPTure[:MODE] <Mode>

This command defines how the size of the the capture buffer is defined for analog demodulation.

Parameters:

<Mode>

AUTO

The capture buffer size is identical to the defined measurement time (see [SENSe:]ADEMod:MTIME).

MANual

The size of the capture buffer is defined manually using the [SENSe:]ADEMod:CAPTure:TIME command.

*RST: AUTO

Example:

ADEM:CAPT MAN

Activates the manual capture buffer processing mode.

Mode:

ADEMOD

Manual operation: See "Capture Mode" on page 57

[SENSe:]ADEMod[:STATe] <State>

This command activates the analog demodulator of the instrument. The instrument will be set to zero span at the current center frequency.

Parameters:

<State>

ON | OFF

*RST: OFF

Example:

ADEM ON

Switches the analog demodulator on.

Mode:

ADEMOD

[SENSe:]ADEMod<n>:AF:CENTer <Frequency>

This command sets the center frequency for AF spectrum result display.

Suffix:

<n>

1...4

irrelevant

Parameters:

<Frequency>

*RST: 1.25 MHz

Example:	<p>ADEM ON, see CALCulate<n>:FEED on page 90 Switches on the analog demodulator</p> <p>CALC:FEED 'XTIM:FM:AFSP', see CALCulate<n>:FEED on page 90 Switches on AF spectrum result display of FM</p> <p>ADEM:BAND 5 MHz, see [SENSe:]ADEMod: BANDwidth BWIDth:DEModulation on page 129 Sets the measurement bandwidth</p> <p>ADEM:AF:CENT 500kHz, see [SENSe:]ADEMod<n>:AF: CENTer on page 121 Sets the AF center frequency</p> <p>ADEM:AF:SPAN 200kHz, see [SENSe:]ADEMod<n>:AF: SPAN on page 122 Sets the AF span</p>
Mode:	ADEMOD
Manual operation:	See " AF Center (AF Spectrum) " on page 42

[SENSe:]ADEMod<n>:AF:COUPling <Coupling>

This command selects the coupling of the AF path of the analyzer in the specified window.

Suffix:

<n> 1...4
window

Parameters:

<Coupling> AC | DC
*RST: AC (PM); DC (FM)

Example:

ADEM:AF:COUP DC
Switches on DC coupling.

Mode:

ADEMOD

Manual operation: See "[AF Coupling AC/DC](#)" on page 35

**[SENSe:]ADEMod<n>:AF:SPAN **

This command sets the span for AF spectrum result display.

The span is limited to half the measurement bandwidth of analog demodulation ([\[SENSe:\]ADEMod:BANDwidth|BWIDth:DEModulation](#) on page 129).

Suffix:

<n> 1...4
irrelevant

Parameters:

 *RST: 2.5 MHz

Example: ADEM ON, see [SENSe:]ADEMod[:STATe] on page 121
Switches on the analog demodulator
CALC:FEED 'XTIM:FM:AFSP', see CALCulate<n>:FEED on page 90
Switches on AF spectrum result display of FM
ADEM:BAND 5 MHz, see [SENSe:]ADEMod:BANDwidth|BWIDth:DEModulation on page 129
Sets the measurement bandwidth
ADEM:AF:CENT 500kHz, see [SENSe:]ADEMod<n>:AF:CENTer on page 121
ADEM:AF:SPAN 200 kHz
Sets the AF span to 200 kHz

Mode: ADEM0D

Manual operation: See "AF Span Manual (AF Spectrum)" on page 42

[SENSe:]ADEMod<n>:AF:SPAN:FULL

This command sets the maximum span for AF spectrum result display.

The maximum span corresponds to half the measurement bandwidth of analog demodulation ([SENSe:]ADEMod:BANDwidth|BWIDth:DEModulation on page 129).

Suffix:

<n> 1...4
irrelevant

Example: ADEM ON, see [SENSe:]ADEMod[:STATe] on page 121
Switches on the analog demodulator
CALC:FEED 'XTIM:FM:AFSP', see CALCulate<n>:FEED on page 90
Switches on AF spectrum result display of FM
ADEM:BAND 5 MHz, see [SENSe:]ADEMod:BANDwidth|BWIDth:DEModulation on page 129
Sets the measurement bandwidth to 5 MHz
ADEM:AF:SPAN:FULL
Sets the AF span to 2.5 MHz

Mode: ADEM0D

Manual operation: See "AF Full Span (AF Spectrum)" on page 43

[SENSe:]ADEMod<n>:AF:START <Frequency>

This command sets the start frequency for AF spectrum result display.

Suffix:

<n> 1...4
irrelevant

Parameters:

<Frequency> *RST: 0 MHz

Example:	ADEM ON, see [SENSe:]ADEMod[:STATe] on page 121 Switches on the analog demodulator CALC:FEED 'XTIM:FM:AFSP', see CALCulate<n>:FEED on page 90 Switches on AF spectrum result display of FM ADEM:BAND 5 MHz, see [SENSe:]ADEMod: BANDwidth BWIDth:DEModulation on page 129 Sets the measurement bandwidth to 5 MHz ADEM:AF:STAR 0 kHz Sets the AF start frequency to 0 kHz [SENSe:]ADEMod<n>:AF:STOP on page 124 Sets the AF stop frequency to 500 kHz
Mode:	ADEM0D
Manual operation:	See " AF Start " on page 42

[SENSe:]ADEMod<n>:AF:STOP <Frequency>

This command sets the stop frequency for AF spectrum result display.

The stop frequency is limited to half the measurement bandwidth of analog demodulation ([\[SENSe:\]ADEMod:BANDwidth|BWIDth:DEModulation](#) on page 129).

Suffix:

<n>	1...4 irrelevant
-----	---------------------

Parameters:

<Frequency>	*RST: 2.5 MHz
-------------	---------------

Example:	ADEM ON, see [SENSe:]ADEMod[:STATe] on page 121 Switches on the analog demodulator CALC:FEED 'XTIM:FM:AFSP', see CALCulate<n>:FEED on page 90 Switches on AF spectrum result display of FM ADEM:BAND 5 MHz, see [SENSe:]ADEMod: BANDwidth BWIDth:DEModulation on page 129 Sets the measurement bandwidth to 5 MHz [SENSe:]ADEMod<n>:AF:STARt on page 123 Sets the AF start frequency to 0 kHz ADEM:AF:STOP 500 kHz Sets the AF stop frequency to 500 kHz
Mode:	ADEM0D
Manual operation:	See " AF Stop " on page 42

[SENSe:]ADEMod:AM[:ABSolute][:TDOMain]:RESult? <TraceMode>

This command reads the result data of the RF signal in zero span in the specified trace mode. The data format of the output data block is defined by the FORMat command (see [Chapter 2.3.6.2, "Formats for Returned Values: ASCII Format and Binary Format"](#), on page 118).

The output unit is dBm (logarithmic display) or V (linear display).

Query parameters:

<TraceMode> WRITe | AVERage | MAXHold | MINHold | VIEW

The specified trace mode must be one of those configured by [\[SENSe:\]ADEMod:AM\[:ABSolute\]\[:TDOMain\]\[:TYPE\]](#) on page 125. Otherwise a query error is generated. For details on trace modes see [Chapter 2.3.6.1, "Trace Mode Result Types"](#), on page 118.

Example:

```
ADEM:SET 8MHz,32000,EXT,POS,-500,30
```

Sets up demodulator parameters

```
ADEM:AM AVER,MAXH,MINH
```

Sets up AM results to be measured

```
ADEM ON
```

Switches on demodulator

```
INIT; *WAI
```

Starts measurement and waits for sync

```
FORM ASC
```

Selects output format

```
ADEM:AM:RES? AVER
```

Reads AM average results

```
ADEM:AM:RES? MAXH
```

Reads AM max hold results

```
ADEM:AM:RES? MINH
```

Reads AM min hold results

Usage: Query only

Mode: ADEMOD

[SENSe:]ADEMod:AM[:ABSolute][:TDOMain][:TYPE] <TraceMode>

This command selects the trace modes of the RF signal to be measured simultaneously in zero span. For each of the six available traces a mode can be defined.

Parameters:

<TraceMode> <TraceMode1>, <TraceMode2>, <TraceMode3>, <Trace-
Mode4>, <TraceMode5>, <TraceMode6>

WRITe | AVERage | MAXHold | MINHold | VIEW | OFF

For details on trace modes see [Chapter 2.3.6.1, "Trace Mode Result Types"](#), on page 118.

*RST: WRITe,OFF,OFF,OFF,OFF,OFF (FM-
Stereo:OFF,OFF,OFF,OFF,OFF,OFF)

Remote Commands of the Analog Demodulation (R&S FSV-K7)

Example: ADEM:AM AVER,MAXH,MINH,OFF,OFF,OFF
Determines average, max hold and min hold values simultaneously for the traces 1-3.
ADEM:AM WRIT,OFF,OFF,OFF,OFF,OFF
Determines only the current measurement values for trace 1.
ADEM:AM OFF,OFF,OFF,OFF,OFF,OFF
Switches AM demodulation off.

Mode: ADEM0D

[SENSe:]ADEMod:AM:RELative[:TDOMain][:TYPE] <TraceMode>

This command selects the result types to be measured simultaneously by AM demodulation.

Parameters for setting and query:

<TraceMode> <TraceMode1>, <TraceMode2>, <TraceMode3>, <TraceMode4>, <TraceMode5>, <TraceMode6>

WRITe | AVERage | MAXHold | MINHold | VIEW | OFF

For details on trace modes see [Chapter 2.3.6.1, "Trace Mode Result Types"](#), on page 118.

*RST: WRITe,OFF,OFF,OFF,OFF,OFF (FM-Stereo:OFF,OFF,OFF,OFF,OFF,OFF)

Example: ADEM:AM:REL AVER,MAXH,MINH
Determines average, max hold and min hold values simultaneously.
ADEM:AM:REL WRIT,OFF,OFF
Determines only the current measurement values.
ADEM:AM:REL OFF,OFF,OFF
Switches AM demodulation off.

Mode: ADEM0D

[SENSe:]ADEMod:AM:RELative[:TDOMain]:RESult? <TraceMode>

This command reads the result data obtained by AM demodulation for the specified result type. The data format of the output data block is defined by the FORMat command (see [Chapter 2.3.6.2, "Formats for Returned Values: ASCII Format and Binary Format"](#), on page 118).

The output unit is %.

Query parameters:

<TraceMode> WRITe | AVERage | MAXHold | MINHold | VIEW
The specified trace mode must be one of those configured by [\[SENSe:\]ADEMod:AM\[:ABSolute\] \[:TDOMain\] \[:TYPE\]](#) on page 125. Otherwise a query error is generated.
For details on trace modes see [Chapter 2.3.6.1, "Trace Mode Result Types"](#), on page 118.

Remote Commands of the Analog Demodulation (R&S FSV-K7)

Example: ADEM:SET 8MHz, 32000, EXT, POS, -500, 30
 Sets up demodulator parameters
 ADEM:FM AVER, MAXH, MINH
 Selects FM results to be measured
 ADEM:AM:REL WRIT, OFF, OFF
 Selects AM results to be measured
 ADEM ON
 Switches on demodulator
 INIT; WAI
 Starts measurement and waits for sync
 FORM ASC
 Selects output format
 ADEM:FM:RES? AVER
 Reads FM average results
 ADEM:FM:RES? MAXH
 Reads FM max hold results
 ADEM:FM:RES? MINH
 Reads FM min hold results
 ADEM:AM:REL:RES? WRIT
 Reads current AM result data

Usage: Query only

Mode: ADEMOD

[SENSe:]ADEMod:AM:RELative:AFSPectrum[:TYPE] <TraceMode>

This command selects the AF spectrum result types of the AM-demodulated signal to be measured simultaneously.

Note: in FM stereo mode (option K7S), only those traces can be measured that are currently displayed in at least one screen.

Parameters:

<TraceMode> <TraceMode1>, <TraceMode2>, <TraceMode3>, <Trace-
 Mode4>, <TraceMode5>, <TraceMode6>

WRITe | AVERage | MAXHold | MINHold | VIEW | OFF

For details on trace modes see [Chapter 2.3.6.1, "Trace Mode Result Types"](#), on page 118.

*RST: WRITe, OFF, OFF, OFF, OFF, OFF (FM-
 Stereo: OFF, OFF, OFF, OFF, OFF, OFF)

Example: ADEM:AM:REL:AFSP AVER, MAXH, MINH
 Determines average, maximum and minimum value simultane-
 ously
 ADEM:AM:REL:AFSP WRIT, OFF, OFF
 Determines only current measurement results
 ADEM:AM:REL:AFSP OFF, OFF, OFF
 Switches off calculation of the AF spectrum

Mode: ADEMOD

[SENSe:]ADEMod:AM:RELative:AFSPectrum:RESult? <TraceMode>

This command reads out the AF spectrum result data of the AM-demodulated signal for the specified result type. The data format of the output data is determined with the FORMat command (see [Chapter 2.3.6.2, "Formats for Returned Values: ASCII Format and Binary Format"](#), on page 118).

The output unit is dB (logarithmic display) or % (linear display).

Query parameters:

<TraceMode> WRITe | AVERage | MAXHold | MINHold | VIEW

The specified trace mode must be one of those configured by [SENSe:]ADEMod:AM[:ABSolute][:TDOMain][:TYPE] on page 125. Otherwise a query error is generated. For details on trace modes see [Chapter 2.3.6.1, "Trace Mode Result Types"](#), on page 118.

Example:

ADEM:SET 8MHz,32000,EXT,POS,-500,30

Sets the demodulator

ADEM:FM AVER,MAXH,MINH

Selects the FM results to be measured

ADEM:AM:REL WRIT,OFF,OFF

Selects the AM results to be measured

ADEM:AM:REL:AFSP WRIT,OFF,OFF

Selects the AF spectrum results of the demodulated AM signal to be measured

ADEM ON

Switches on the demodulator

INIT; WAI

Starts the measurement and waits for the termination

FORM ASC

Selects the output format

ADEM:FM:RES? AVER

Reads the FM average result data

ADEM:FM:RES? MAXH

Reads the FM Maxhold result data

ADEM:FM:RES? MINH

Reads the FM Minhold result data

ADEM:AM:REL:RES? WRIT

Reads the current AM result data

ADEM:AM:REL:AFSP:RES? WRIT

Reads the current AF spectrum result data of the demodulated AM signal

Usage: Query only

Mode: ADEMOD

[SENSe:]ADEMod:BANDwidth|BWIDth:DEModulation <Bandwidth>

This command defines the demodulation bandwidth used for analog demodulation. The required sampling rate is automatically set depending on the selected demodulation bandwidth. The available demodulation bandwidths are determined by the existing sampling rates. For details on the relation between demodulation bandwidth and sampling rate refer to [Chapter 2.1.3, "Sample Rate, Measurement Time and Trigger Offset"](#), on page 13.

Parameters:

<Bandwidth>

*RST: 5 MHz

For details on the correlation of bandwidth and sample rate refer to chapter "Instrument Functions", section "Analog Demodulation (Option K7)" – [Chapter 2.1.3, "Sample Rate, Measurement Time and Trigger Offset"](#), on page 13.

Example:

ADEM:BAND:DEM 1MHz

Sets the demodulation bandwidth to 1 MHz.

Mode:

ADEMOD

[SENSe:]ADEMod:BANDwidth|BWIDth:DEModulation:TYPE <FilterType>

This command defines the type of demodulation filter to be used.

Parameters:

<FilterType>

FLAT

Standard flat demodulation filter

GAUSS

Gaussian filter for optimized settling behaviour

*RST: FLAT

Example:

BAND:DEM:TYPE GAUS

Selects the Gaussian filter.

Mode:

ADEMOD

[SENSe:]ADEMod:FM[:TDOMain][:TYPE] <Type>

This command selects the result types to be measured simultaneously by FM demodulation.

Parameters:

<Type>

*RST: WRITe,OFF,OFF

<result type 1|2|3|4|5|6>: WRITe, AVERage, MAXHold, MINHold, VIEW, OFF; for details see [Chapter 2.3.6.1, "Trace Mode Result Types"](#), on page 118 .

Example: `[SENSe:]ADEMod:FM[:TDOMain] [:TYPE]` on page 129
 "Creates average, max hold and min hold values simultaneously
`DEM:FM WRIT,OFF,OFF`
 Only creates the current measurement values
`ADEM:FM OFF,OFF,OFF`
 Switches analog demodulator off

Mode: ADEM0D

`[SENSe:]ADEMod:FM[:TDOMain]:RESult <Type>`

This command reads the result data obtained by analog demodulation for the specified result type. The data format of the output data block is defined by the `FORMat` command.

Return values:

`<Type>` `<result type>`: `WRITe`, `AVERage`, `MAXHold`, `MINHold`; for details see [Chapter 2.3.6.1, "Trace Mode Result Types"](#), on page 118. The result type indicated must be one of those configured by `[SENSe:]ADEMod:FM[:TDOMain] [:TYPE]` on page 129. Otherwise a query error will be generated.

Return values ASCII Format (`FORMat ASCII`) or Binary Format (`FORMat REAL,32`); for details see [Chapter 2.3.6.2, "Formats for Returned Values: ASCII Format and Binary Format"](#), on page 118 .
 Default unit: Hz

Example: `ADEM:SET 8MHz,32000,EXT,POS,-500,30`, see `[SENSe:]ADEMod:SET` on page 138
 Sets up demodulator parameters
`ADEM:FM AVER,MAXH,MINH`, see `[SENSe:]ADEMod:FM[:TDOMain] [:TYPE]` on page 129
 Selects FM results to be measured
`ADEM:AM WRIT,OFF,OFF`
 Selects AM results to be measured
`ADEM ON`, see `[SENSe:]ADEMod[:STATe]` on page 121
 Switches on demodulator
`INIT; WAI`
 Starts measurement and waits for sync
`FORM ASC`, see `FORMat [:DATA]` on page 184
 Selects output format
`ADEM:FM:RES? AVER`
 Reads FM average results
`ADEM:FM:RES? MAXH`
 Reads FM max hold results
`ADEM:FM:RES? MINH`
 Reads FM min hold results
`ADEM:AM:RES? WRIT`
 Reads current AM results

Mode: ADEM0D

[SENSe:]ADEMod:FM:AFSPectrum[:TYPE] <Type>

This command selects the AF spectrum result types of the FM demodulated signal to be measured simultaneously.

Parameters:

<Type> *RST: OFF,OFF,OFF
 <result type 1|2|3|4|5|6>: WRITe, AVERAge, MAXHold, MINHold, VIEW, OFF; for details see [Chapter 2.3.6.1, "Trace Mode Result Types"](#), on page 118.
 The result type "AF spectrum of the FM demodulated signal" cannot be activated at the same time as "AF spectrum of AM or PM demodulated signal".

Example:

ADEM:FM:AFSP AVER,MAXH,MINH

Determines average, maximum and minimum value simultaneously

ADEM:FM:AFSP WRIT,OFF,OFF

Determines only current measurement results

ADEM:FM:AFSP OFF,OFF,OFF

Switches calculation of AF spectrum off

Mode: ADEM0D

[SENSe:]ADEMod:FM:AFSPectrum:RESult <Type>

This command reads out the AF spectrum result data of the FM demodulated signal for the specified result type. The data format of the output data is determined with the FORMat command.

Return values:

<Type> <result type>: WRITe, AVERAge, MAXHold, MINHold; for details see [Chapter 2.3.6.1, "Trace Mode Result Types"](#), on page 118.
 The specified result type must be one of those configured with the `[SENSe:]ADEMod:FM:AFSPectrum[:TYPE]` command.
 Otherwise a query error will be generated.

Return values ASCII Format (FORMat ASCII) or Binary Format (FORMat REAL,32); for details see [Chapter 2.3.6.2, "Formats for Returned Values: ASCII Format and Binary Format"](#), on page 118.

Default unit: dB (logarithmic display) or Hz (linear display)

Remote Commands of the Analog Demodulation (R&S FSV-K7)

Example:	<p>ADEM:SET 8MHz,32000,EXT,POS,-500,30, see [SENSe:]ADEMod:SET on page 138</p> <p>Sets demodulator</p> <p>ADEM:FM AVER,MAXH,MINH, see [SENSe:]ADEMod:FM[:TDOMain][:TYPE] on page 129</p> <p>Selects the FM results to be measured</p> <p>ADEM:AM:REL WRIT,OFF,OFF, see [SENSe:]ADEMod:FM:AFSPpectrum[:TYPE] on page 131</p> <p>Selects the AM results to be measured</p> <p>ADEM:FM:AFSP WRIT,OFF,OFF, see [SENSe:]ADEMod:FM:AFSPpectrum[:TYPE] on page 131</p> <p>Selects the AF spectrum results of the demodulated FM signal to be measured</p> <p>ADEM ON, see [SENSe:]ADEMod[:STATe] on page 121</p> <p>Switches the demodulator on</p> <p>INIT; WAI</p> <p>Starts the measurement and waits for termination</p> <p>FORM ASC, see FORMat[:DATA] on page 184</p> <p>Selects output format</p> <p>ADEM:FM:RES? AVER, see [SENSe:]ADEMod:FM[:TDOMain]:RESult on page 130</p> <p>Reads FM average result data</p> <p>ADEM:FM:RES? MAXH, see [SENSe:]ADEMod:FM[:TDOMain]:RESult on page 130</p> <p>Reads FM maxhold result data</p> <p>ADEM:FM:RES? MINH, see [SENSe:]ADEMod:FM[:TDOMain]:RESult on page 130</p> <p>Reads FM minhold result data</p> <p>ADEM:AM:RES? WRIT, see [SENSe:]ADEMod:AM[:ABSolute][:TDOMain]:RESult? on page 125</p> <p>Reads current AM result data</p> <p>ADEM:FM:AFSP:RES? WRIT</p> <p>Reads current AF spectrum result data of demodulated FM signal</p>
Mode:	ADEMOD

[SENSe:]ADEMod:FM:OFFSet <Type>

This command calculates the FM offset of the currently available measurement data set.

If averaging has been activated before acquiring the data set (using [SENSe:]ADEMod:FM[:TDOMain][:TYPE] on page 129, the averaged FM offset over several measurements can also be obtained by setting <result type> = AVERage.

The offset thus determined differs from the one calculated by the `CALCulate<n>:MARKer:FUNCTION:ADEMod:FERRor[:RESult<t>]?` on page 87 command since, for determination of the frequency deviation, the modulation is removed by means of low pass filtering, producing results that are different from those obtained by averaging.

Parameters:

<Type>

<result type> | IMMEDIATE | AVERAGE

IMMEDIATE

The current measurement results will be used for calculating the FM offset

AVERAGE

The measurement results that were averaged over the given # of measurements will be used for calculating the FM offset

If no average measurement was active during the last measurement sequence only the `[SENSe:]ADEMod:FM:OFFSet IMMEDIATE` command (see `[SENSe:]ADEMod:FM:OFFSet` on page 132) will return a correct result (data to calculate the offset are taken from the last measured data set).

`[SENSe:]ADEMod:FM:OFFSet AVERAGE` will cause a query error in this case.

Example:

`ADEM:SET 8MHz,32000,EXT,POS,-500,30`, see `[SENSe:]ADEMod:SET` on page 138

Sets up demodulator parameters to execute 30 measurements

`ADEM:FM AVER,OFF,OFF`

Selects FM results to perform averaging

`ADEM:AM OFF,OFF,OFF`

Switches off AM demodulation

`ADEM ON`, see `[SENSe:]ADEMod[:STATe]` on page 121

Switches on analog demodulator

`INIT; WAI`

Starts measurement and waits for sync

`ADEM:FM:OFFS? IMM`

Reads FM offset of last measurement of the sequence of 30

`ADEM:FM:OFFS? AVER`

Reads FM offset averaged over 30 measurements

Mode:

ADEMOD

[SENSe:]ADEMod:MTIME <Time>

This command defines the measurement time for analog demodulation.

Parameters:

<Time>

*RST: 62.5us

Example:

`ADEM:MTIM 62.5us`

Sets the measurement time to 62.5 µs.

Mode:

ADEMOD

Manual operation: See "Meas Time" on page 31

[SENSe:]ADEMod:PM[:TDOMain][:TYPE] <Type>

This command selects the result types of the PM-demodulated signal to be created simultaneously.

Parameters:

<Type> *RST: OFF,OFF,OFF
 <result type 1|2|3|4|5|6>: WRITe, AVERAge, MAXHold, MINHold, VIEW; for details see [Chapter 2.3.6.1, "Trace Mode Result Types"](#), on page 118.

Example:

ADEM:PM AVER,MAXH,MINH, see [\[SENSe:\]ADEMod:PM\[:TDOMain\]\[:TYPE\]](#) on page 134
 Determines average, maximum and minimum value simultaneously
 ADEM:PM WRIT,OFF,OFF
 Determines only current measurement results
 ADEM:PM OFF,OFF,OFF
 Switches the PM demodulator off.

Mode: ADEMOD

[SENSe:]ADEMod:PM[:TDOMain]:RESult <Type>

This command reads the result data of the PM demodulation for the specified result type. The data format of the output data is determined with the FORMat command.

Return values:

<Type> <result type>: WRITe, AVERAge, MAXHold, MINHold; for details see [Chapter 2.3.6.1, "Trace Mode Result Types"](#), on page 118. The specified result type must be one of those configured with the [\[SENSe:\]ADEMod:PM\[:TDOMain\]\[:TYPE\]](#) command. Otherwise a query error will be generated.

Return values ASCII Format (FORMat ASCII) or Binary Format (FORMat REAL,32); for details see [Chapter 2.3.6.2, "Formats for Returned Values: ASCII Format and Binary Format"](#), on page 118 .
 Default unit: dB (logarithmic display) or RAD or DEG (linear display)

Remote Commands of the Analog Demodulation (R&S FSV-K7)

Example:	<p>ADEM:SET 8MHz,32000,EXT,POS,-500,30, see [SENSe:]ADEMod:SET on page 138 Sets the demodulator parameters.</p> <p>ADEM:PM AVER,MAXH,MINH, see [SENSe:]ADEMod:PM[:TDOMain][:TYPE] on page 134 Selects the PM results to be measured.</p> <p>ADEM:AM WRIT,OFF,OFF Selects the AM results to be measured.</p> <p>ADEM ON, see [SENSe:]ADEMod[:STATe] on page 121 Switches on the demodulator.</p> <p>INIT; WAI Starts the measurement and waits for termination.</p> <p>FORM ASC, see FORMAt[:DATA] on page 184 Selects the output format.</p> <p>ADEM:PM:RES? AVER Reads the PM average result data.</p> <p>ADEM:PM:RES? MAXH Reads the PM maxhold result data.</p> <p>ADEM:PM:RES? MINH Reads the PM minhold result data.</p> <p>ADEM:AM:RES? WRIT Reads the current AM result data.</p>
Mode:	ADEMOD

[SENSe:]ADEMod:PM:AFSPectrum[:TYPE] <Type>

This command selects the AF spectrum result types of the PM-demodulated signal to be measured simultaneously.

Parameters:

<Type> *RST: OFF,OFF,OFF
<result type 1|2|3|4|5|6>: WRITe, AVERAge, MAXHold, MINHold, VIEW; for details see [Chapter 2.3.6.1, "Trace Mode Result Types"](#), on page 118.
The result type "AF spectrum of the PM demodulated signal" cannot be activated at the same time as "AF spectrum of AM or FM demodulated signal".

Example:	<p>ADEM:PM:AFSP AVER,MAXH,MINH Determines average, maximum and minimum value simultaneously</p> <p>ADEM:PM:AFSP WRIT,OFF,OFF Determines only current measurement results</p> <p>ADEM:PM:AFSP OFF,OFF,OFF Switches calculation of AF spectrum off</p>
-----------------	--

Mode: ADEMOD

[SENSe:]ADEMod:PM:AFSPectrum:RESult <Type>

This command reads out the AF spectrum result data of the PM-demodulated signal for the specified result type. The data format of the output data is determined with the FORMat command.

Return values:

<Type> <result type>: WRITe, AVERage, MAXHold, MINHold; for details see [Chapter 2.3.6.1, "Trace Mode Result Types"](#), on page 118 . The specified result type must be one of those configured with the `[SENSe:]ADEMod:PM:AFSPectrum[:TYPE]` on page 135 command. Otherwise a query error will be generated.

Return values ASCII Format (FORMat ASCII) or Binary Format (FORMat REAL,32); for details see [Chapter 2.3.6.2, "Formats for Returned Values: ASCII Format and Binary Format"](#), on page 118 .

Default unit: dB (logarithmic display) or RAD or DEG (linear display)

Remote Commands of the Analog Demodulation (R&S FSV-K7)

Example:	<p>ADEM:SET 8MHz,32000,EXT,POS,-500,30, see [SENSe:]ADEMod:SET on page 138</p> <p>Sets demodulator</p> <p>ADEM:PM AVER,MAXH,MINH, see [SENSe:]ADEMod:PM[:TDOMain][:TYPE] on page 134</p> <p>Selects the PM results to be measured</p> <p>ADEM:AM:REL WRIT,OFF,OFF, see [SENSe:]ADEMod:FM:AFSPectrum[:TYPE] on page 131</p> <p>Selects the AM results to be measured</p> <p>ADEM:PM:AFSP WRIT,OFF,OFF, see [SENSe:]ADEMod:PM:AFSPectrum[:TYPE] on page 135</p> <p>Selects the AF spectrum results of the demodulated PM signal to be measured</p> <p>ADEM ON, see [SENSe:]ADEMod[:STATe] on page 121</p> <p>Switches the demodulator on</p> <p>INIT; WAI</p> <p>Starts the measurement and waits for termination</p> <p>FORM ASC, see FORMat[:DATA] on page 184</p> <p>Selects output format</p> <p>ADEM:PM:RES? AVER, see [SENSe:]ADEMod:PM:AFSPectrum:RESult on page 136</p> <p>Reads PM average result data</p> <p>ADEM:PM:RES? MAXH, see [SENSe:]ADEMod:PM:AFSPectrum:RESult on page 136</p> <p>Reads PM maxhold result data</p> <p>ADEM:PM:RES? MINH, see [SENSe:]ADEMod:PM:AFSPectrum:RESult on page 136</p> <p>Reads PM minhold result data</p> <p>ADEM:AM:RES? WRIT, see [SENSe:]ADEMod:PM:AFSPectrum:RESult on page 136</p> <p>Reads current AM result data</p> <p>ADEM:PM:AFSP:RES? WRIT</p> <p>Reads current AF spectrum result data of demodulated PM signal</p>
Mode:	ADEMOD

[SENSe:]ADEMod:PM:RPOint[:X] <Time>

This command determines the position where the phase of the PM-demodulated signal is set to 0 rad. The maximum possible value depends on the measurement time selected in the instrument; this value is output in response to the query

ADEM:PM:RPO:X? MAX.

Parameters:

<Time> 0 s to measurement time
*RST: 0 s

Example: ADEM:PM:RPO 500us
Sets the position where the phase to 0 rad setting to 500 µs.

Usage:	SCPI confirmed
Mode:	ADEM0D
Manual operation:	See " Zero Phase Reference Point " on page 38

[SENSe:]ADEMod:RLEnGth?

This command returns the record length set up for the current analog demodulation measurement.

Example: ADEM:RLEN?
Returns the current record length.

Usage: Query only

Mode: ADEM0D

[SENSe:]ADEMod:SET <sample rate> | <record length> | <trigger source> | <trigger slope> | <offset samples> | <# of meas>

This command configures the analog demodulator of the instrument.

Parameters:

<sample rate>	<p>numeric value The frequency at which measurement values are taken from the A/D-converter and stored in I/Q memory. Allowed range: refer to Sample Rate, Measurement Time and Trigger Offset. Note: for FM stereo measurements (K7S option), the sample rate is always 500 kHz (as the demodulation bandwidth is permanently set to 400 kHz). Thus, this parameter is ignored in this case. *RST: 8 MHz</p>
<record length>	<p>Number of samples to be stored in I/Q memory. Range: 1 to 400001 with AF filter or AF trigger active, 1 to 480001 with both AF filter and AF trigger deactive *RST: 501)</p>
<trigger source>	<p>Selection of the trigger source to use for the demodulator. IMMediate EXTernal IFPower RFPower AF AM AMRelative FM PM Note: After selecting IF Power, the trigger threshold can be set with the <code>TRIGger<n>[:SEquence]:LEVel:IFPower</code> command. *RST: IMMediate</p>

Remote Commands of the Analog Demodulation (R&S FSV-K7)

<trigger slope>	<p>POSitive NEGative</p> <p>Used slope of the trigger signal. The value indicated here will be ignored for <trigger source> = IMMEDIATE.</p> <p>*RST: POSitive</p>
<offset samples>	<p>Number of samples to be used as an offset to the trigger signal. For details refer to Chapter 2.1.3, "Sample Rate, Measurement Time and Trigger Offset", on page 13. The value indicated here is ignored for <trigger source> = "IMMEDIATE".</p> <p>*RST: 0</p>
<# of meas>	<p>Number of repetitions of the measurement to be executed. The value indicated here is especially necessary for the average/maxhold/minhold function.</p> <p>Range: 0 to 32767</p> <p>*RST: 0</p>
Example:	<pre>ADEM:SET 8MHz,32000,EXT,POS,-500,30</pre> <p>Performs a measurement at: sample rate = 8 MHz record length = 32000 trigger source = EXTERNAL trigger slope = POSitive offset samples = -500 (500 samples before trigger occurred) # of meas = 30</p>
Mode:	ADEM0D

[SENSe:]ADEMod:SPECTrum[:TYPE] <Type>

This command selects the result types to be created in parallel by the RF spectrum measurement with active analog demodulation.

Parameters:

<Type> *RST: OFF,OFF,OFF
<result type 1|2|3|4|5|6>: WRITe, AVERage, MAXHold, MINHold, VIEW, OFF; for details see [Chapter 2.3.6.1, "Trace Mode Result Types"](#), on page 118.

Example:

```
ADEM:SPEC AVER,MAXH,MINH
```

Creates average, max hold and min hold values at a time

```
ADEM:SPEC WRIT,OFF,OFF
```

Only creates the current measurement values

```
ADEM:SPEC OFF,OFF,OFF
```

Switches analog demodulator off

Mode: ADEM0D

[SENSe:]ADEMod:SPECTrum:BANDwidth|BWIDth[:RESolution] <Bandwidth>

This command sets the resolution bandwidth for the spectrum representation that was determined from the analog demodulation data.

The recording time required is calculated from the sampling rate indirectly set via [\[SENSe:\]ADEMod:SPECTrum:SPAN\[:MAXimum\]](#) on page 141 or [\[SENSe:\]ADEMod:BANDwidth|BWIDth:DEModulation](#) on page 129. If the available recording time is not sufficient for the given bandwidth, the recording time is set to its maximum and the resolution bandwidth is enlarged to the resulting bandwidth.

Parameters:

<Bandwidth> refer to data sheet
*RST: 61.2 kHz

Example:

ADEM ON, see [\[SENSe:\]ADEMod\[:STATE\]](#) on page 121
Switches on the analog demodulator

CALC:FEED 'XTIM:SPEC', see [CALCulate<n>:FEED](#)
on page 90

Switches on the RF spectrum result display
or

CALC:FEED 'XTIM:FM:AFSP', see [CALCulate<n>:FEED](#)
on page 90

Switches on the AF spectrum result display of FM signal

ADEM:SPEC:BAND 61.2kHz

Sets the resolution bandwidth to 61.2 kHz.

Mode: AEMOD

Manual operation: See "[Res BW \(span > 0\)](#)" on page 51

[SENSe:]ADEMod:SPECTrum:RESult <Type>

This command reads out the RF spectrum result data for the specified result type. The data format of the output data block is defined by the [FORMat](#) command.

Return values:

<Type> <result type>: WRITe, AVERAge, MAXHold, MINHold; for details see [Chapter 2.3.6.1, "Trace Mode Result Types"](#), on page 118. The result type indicated must be one of those configured by [\[SENSe:\]ADEMod:SPECTrum\[:TYPE\]](#) on page 139. Otherwise a query error will be generated.

Return values ASCII Format (FORMat ASCII) or Binary Format (FORMat REAL,32); for details see [Chapter 2.3.6.2, "Formats for Returned Values: ASCII Format and Binary Format"](#), on page 118. The output units are described in [CALCulate<n>:MARKer<m>:PEXCursion](#) on page 104.

Remote Commands of the Analog Demodulation (R&S FSV-K7)

Example:	<p>ADEM:SET 8MHz,32000,EXT,POS,-500,30, see [SENSe:]ADEMod:SET on page 138</p> <p>Sets demodulator</p> <p>ADEM:SPEC AVER,MAXH,MINH</p> <p>Selects RF spectrum results to be measured</p> <p>ADEM:SPEC WRIT,OFF,OFF</p> <p>Selects the AM results to be measured</p> <p>ADEM ON, see [SENSe:]ADEMod[:STATE] on page 121</p> <p>Switches the demodulator on</p> <p>INIT; WAI</p> <p>Starts the measurement and waits for termination</p> <p>FORM ASC, see FORMat[:DATA] on page 184</p> <p>Selects output format</p> <p>ADEM:SPEC:RES? AVER</p> <p>Reads RF spectrum average results</p> <p>ADEM:SPEC:RES? MAXH</p> <p>Reads RF spectrum max hold results</p> <p>ADEM:SPEC:RES? MINH</p> <p>Reads RF spectrum min hold results</p> <p>ADEM:SPEC:RES? WRIT</p> <p>Reads spectrum current results</p>
Mode:	ADEMOD

[SENSe:]ADEMod:SPECTrum:SPAN[:MAXimum] <FreqRange>

This command sets the maximum frequency range for displaying the RF spectrum that was determined from the FM demodulation data. The maximum span corresponds to the measurement bandwidth of analog demodulation (for details refer to [SENSe:]ADEMod:BANDwidth|BWIDth:DEModulation on page 129).

For details refer on the relation of bandwidth and sample rate refer to [Sample Rate, Measurement Time and Trigger Offset](#).

Parameters:

<FreqRange> *RST: 5 MHz

Example:	<p>ADEM ON, see [SENSe:]ADEMod[:STATE] on page 121</p> <p>Switches on the analog demodulator</p> <p>CALC:FEED 'XTIM:SPEC', see CALCulate<n>:FEED on page 90</p> <p>Switches on RF spectrum result display.</p> <p>ADEM:SPEC:SPAN:MAX 5 MHz</p> <p>Sets the max. span to 5 MHz</p> <p>ADEM:SPEC:SPAN:ZOOM 1 MHz</p> <p>Sets the displayed span to 1 MHz</p>
-----------------	--

Mode: ADEMOD

[SENSe:]ADEMod:SPECTrum:SPAN:ZOOM <FreqRange>

This command sets the frequency range for the RF spectrum result display determined from analog demodulation data. The frequency range for result display is limited to the maximum span ([\[SENSe:\]ADEMod:SPECTrum:SPAN\[:MAXimum\]](#) on page 141) or to the measurement bandwidth of analog demodulation ([\[SENSe:\]ADEMod:BANDwidth|BWIDth:DEModulation](#) on page 129).

Parameters:

<FreqRange> *RST: 5 MHz

Example:

ADEM ON, see [\[SENSe:\]ADEMod\[:STATe\]](#) on page 121
Switches on the analog demodulator
CALC:FEED 'XTIM:SPEC', see [CALCulate<n>:FEED](#)
on page 90
Switches on RF spectrum result display.
ADEM:SPEC:SPAN:MAX 5 MHz, see [\[SENSe:\]ADEMod:SPECTrum:SPAN\[:MAXimum\]](#) on page 141
Sets the maximum span to 5 MHz
ADEM:SPEC:SPAN:ZOOM 1 MHz
Sets displayed span to 1 MHz

Mode: ADEMOD

Manual operation: See "[Span Manual \(RF Spectrum\)](#)" on page 42
See "[Full Span \(RF Spectrum\)](#)" on page 43

[SENSe:]ADEMod:SQUelch[:STATe] <State>

This command activates the squelch function, i.e. if the signal falls below a defined threshold (see [\[SENSe:\]ADEMod:SQUelch:LEVel](#) on page 142), the demodulated data is automatically set to 0.

Parameters:

<State> ON | OFF
*RST: OFF

Example:

DEM:SQU ON
Signals below the level threshold are squelched.

Usage: SCPI confirmed

Mode: A, ADEMOD, SFM

Manual operation: See "[Squelch](#)" on page 37

[SENSe:]ADEMod:SQUelch:LEVel <Threshold>

This command defines the level threshold below which the demodulated data is set to 0 if squelching is enabled (see [\[SENSe:\]ADEMod:SQUelch\[:STATe\]](#) on page 142).

Parameters:

<Threshold> numeric value
 The absolute threshold level
 Range: -150 dBm to 30 dBm
 *RST: -40 dBm

Example:

DEM:SQU:LEV -80
 If the signal drops below -80 dBm, the demodulated data is set to 0.

Usage: SCPI confirmed

Mode: ADEMODO, SFM

Manual operation: See "[Squelch Level](#)" on page 37

[SENSe:]ADEMod:SRATe?

This command returns the sample rate set up for the current analog demodulation measurement.

Example: ADEM:SRAT?
 Returns the current sample rate.

Usage: Query only

Mode: ADEMODO

[SENSe:]ADEMod<n>:ZOOM[:STATe] <State>

The command enables or disables the zoom function for the analog-demodulated measurement data in the specified window. Depending on the selected measurement time and the demodulation bandwidth, the number of recorded test points may be greater than that shown on the display.

If the zoom function is enabled, the default number of sweep points in "Spectrum" mode of the result memory are displayed from the specified start time with [\[SENSe:\]ADEMod<n>:ZOOM:START](#) on page 144.

If the zoom function is disabled, data reduction is used to adapt the test points to the number of points available on the display.

Suffix:

<n> 1...4
 window

Parameters:

<State> ON | OFF
 *RST: OFF

Example: ADEM:ZOOM ON
 Switches on the zoom function

Mode: ADEMODO

Manual operation: See "State On / Off" on page 36

[SENSe:]ADEMod<n>:ZOOM:START <Time>

The command selects the start time for the display of individual measured values of the analog demodulation in the specified window. The maximum possible value depends on the measurement time, which is set in the instrument and can be queried with the [SENSe:]ADEMod:MTIME on page 133 command.

If the zoom function is enabled, the default number of sweep points in "Spectrum" mode of the result memory are displayed from the specified start time with [SENSe:]ADEMod<n>:ZOOM:START on page 144.

Suffix:

<n> 1...4
 window

Parameters:

<Time> *RST: 0 s
 0 s to measurement time – (default number of sweep points in "Spectrum" mode – 1 * 1/sample rate)

Example: ADEM:ZOOM:STAT ON (see [SENSe:]ADEMod<n>:ZOOM[:STATe] on page 143)
 Switches on the zoom function
 ADEM:ZOOM:STAR 500us
 Sets the starting point of the display to 500 µs.

Mode: ADEMOD

Manual operation: See "Start" on page 36

[SENSe:]ADEMod<n>:ZOOM:LENGTH <Length>

The command allows you to define the length of the zoom area for the analog-demodulated measurement data in the specified window manually. If the length is defined manually using this command, the zoom mode is also set to manual.

Suffix:

<n> 1...4
 window

Parameters:

<Length> *RST: sweep time
 Length of the zoom area in seconds.

Example: ADEM:ZOOM:LENG 2s
 Zoom mode is set to manual and the zoom length to 2 seconds.

Mode: ADEMOD

Manual operation: See "Length Manual" on page 36

[SENSe:]ADEMod<n>:ZOOM:LENGth:MODE <Mode>

The command defines whether the length of the zoom area for the analog-demodulated measurement data is defined automatically or manually in the specified window. By default and in automatic mode, the number of sweep points is used as the zoom length. If the zoom length was already entered using [\[SENSe:\]ADEMod<n>:ZOOM:LENGth](#) on page 144, manual zoom mode is set automatically.

Suffix:

<n> 1...4
window

Parameters:

<Mode> AUTO | MAN
*RST: AUTO

Example:

ADEM:ZOOM:LENG:MODE MAN
Zoom function uses the length defined manually.

Mode: ADEMOD

Manual operation: See "[Length Auto](#)" on page 36

2.3.6.4 SENSE:ADJust Subsystem

The ADJust subsystem controls automatic definition of frequency and level settings.

[SENSe:]ADJust:ALL	145
[SENSe:]ADJust:CONFiguration:HYSTeresis:LOWer	145
[SENSe:]ADJust:CONFiguration:HYSTeresis:UPPer	146
[SENSe:]ADJust:CONFigure:LEVel:DURation	146
[SENSe:]ADJust:FREQuency	146
[SENSe:]ADJust:LEVel	147
[SENSe:]ADJust:SCALe:Y:AUTO[:CONTInuous]	147

[SENSe:]ADJust:ALL

This command determines the ideal frequency and level configuration for the current measurement.

Example: ADJ:ALL

Manual operation: See "[Auto All](#)" on page 49

[SENSe:]ADJust:CONFiguration:HYSTeresis:LOWer <Threshold>

This command defines a lower threshold the signal must drop below before the reference level is automatically adjusted when the "Auto Level" function is performed.

For more information see [\[SENSe:\]ADJust:LEVel](#)).

Parameters:

<Threshold> Range: 0 to 200
 *RST: +1 dB
 Default unit: dB

Example: SENS:ADJ:CONF:HYST:LOW 2

Example: For an input signal level of currently 20 dBm, the reference level will only be adjusted when the signal level falls below 18 dBm.

Manual operation: See "[Lower Level Hysteresis](#)" on page 51

[SENSe:]ADJust:CONFIguration:HYSTeresis:UPPer <Threshold>

This command defines an upper threshold the signal must exceed before the reference level is automatically adjusted when the "Auto Level" function is performed.

For more information see [[SENSe:\]ADJust:LEVel](#)).

Parameters:

<Threshold> Range: 0 to 200
 *RST: +1 dB
 Default unit: dB

Example: SENS:ADJ:CONF:HYST:UPP 2

For an input signal level of currently 20 dBm, the reference level will only be adjusted when the signal level rises above 22 dBm.

Manual operation: See "[Upper Level Hysteresis](#)" on page 50

[SENSe:]ADJust:CONFIgure:LEVel:DURation <Duration>

This command defines the duration of the level measurement used to determine the optimal reference level automatically (for SENS:ADJ:LEV ON).

Parameters:

<Duration> <numeric value> in seconds
 Range: 0.001 to 16000.0
 *RST: 0.001
 Default unit: s

Example: ADJ:CONF:LEV:DUR:5

Manual operation: See "[Meas Time Manual](#)" on page 50

[SENSe:]ADJust:FREQUency

This command defines the center frequency and the reference level automatically by determining the highest level in the frequency span.

Example: ADJ:FREQ

Manual operation: See "[Auto Freq](#)" on page 50

[SENSe:]ADJust:LEVel

This command automatically sets the optimal reference level for the current measurement.

You can define a threshold that the signal must exceed before the reference level is adjusted, see [\[SENSe:\]ADJust:CONFIguration:HYSTeresis:UPPer](#) and [\[SENSe:\]ADJust:CONFIguration:HYSTeresis:LOWer](#).

Example: ADJ:LEV

Manual operation: See "Auto Level" on page 50

[SENSe:]ADJust:SCALe:Y:AUTO[:CONTInuous] <state>

Activates automatic scaling of the y-axis. Currently auto-scaling is only available for AF measurements. RF power and RF spectrum measurements are not affected by the auto-scaling.

Parameters:

<state> ON | OFF
*RST: OFF

Example: SENS1:ADJ:SCAL:Y:AUTO ON

Mode: ADEMODO, SFM

Manual operation: See "AF Auto Scale" on page 51

2.3.6.5 SENSe:BANDwidth Subsystem (Analog Demodulation, R&S FSV-K7)

This subsystem controls the setting of the instruments filter bandwidths. Both groups of commands (BANDwidth and BWIDth) perform the same functions.

[\[SENSe:\]BANDwidth|BWIDth:DEMod](#)..... 147
[\[SENSe:\]BANDwidth:DEMod:TYPE](#)..... 148

[SENSe:]BANDwidth|BWIDth:DEMod <Bandwidth>

This command sets the bandwidth for analog demodulation. Depending on the selected demodulation bandwidth, the instrument selects the required sampling rate.

The available values of the demodulation bandwidths are determined by the sampling rates. For details on the correlation between demodulation bandwidth and sampling rate refer to [Chapter 2.1.3, "Sample Rate, Measurement Time and Trigger Offset"](#), on page 13.

Parameters:

<Bandwidth> *RST: 5 MHz

Example: BAND:DEM 1MHz
Sets test bandwidth to 1 MHz

Mode: A-F, ADEMODO

Manual operation: See "Demod BW" on page 30

[SENSe:]BANDwidth:DEMod:TYPE <FilterType>

This command defines the type of demodulation filter to be used.

Parameters:

<FilterType>

FLAT

Standard flat demodulation filter

GAUSS

Gaussian filter for optimized settling behaviour

*RST: FLAT

Example:

BAND:DEMod:TYPE GAUS

Selects the Gaussian filter.

Mode:

ADEMODO

Manual operation: See "Demod Filter" on page 55

2.3.6.6 SENSE:FILTer Subsystem (Analog Demodulation, Analog Demodulation)

The SENSE:FILTer subsystem selects the filters to reduce the bandwidth of the demodulated signal. The selected filters are used for AM, FM and PM demodulation in common.



Using the commands in the SENSE:FILTer subsystem you can define filter settings for each window individually. Note, however, that if the same modulation type is used in several windows, the settings defined for that modulation are used in all the corresponding windows.

Commands of the SENSE:FILTer subsystem

[SENSe:]FILTer<n>:AOFF.....	148
[SENSe:]FILTer<n>:AWEighted[:STATe].....	149
[SENSe:]FILTer<n>:CCIT.....	149
[SENSe:]FILTer<n>:CCIR[:UNWEighted[:STATe].....	150
[SENSe:]FILTer<n>:CCIR:WEIGhted[:STATe].....	150
[SENSe:]FILTer<n>:DEMPHasis[:STATe].....	150
[SENSe:]FILTer<n>:DEMPHasis:TCONstant.....	151
[SENSe:]FILTer<n>:HPASs[:STATe].....	151
[SENSe:]FILTer<n>:HPASs:FREQuency.....	152
[SENSe:]FILTer<n>:LPASs[:STATe].....	152
[SENSe:]FILTer<n>:LPASs:FREQuency[:ABSolute].....	152
[SENSe:]FILTer<n>:LPASs:FREQuency:RELative.....	153

[SENSe:]FILTer<n>:AOFF

This command switches all AF filters in the specified window off.

Suffix:
 <n> 1...4
 window

Example: SENS:FILT:AOFF

Usage: Event

Mode: ADEMODO, SFM

Manual operation: See ["All AF Filter Off"](#) on page 34

[SENSe:]FILTer<n>:AWEighted[:STATe] <State>

This command activates/deactivates the "A" weighting filter in the specified window.
 For details on the A weighted filter see ["A Weighted"](#) on page 33.

Suffix:
 <n> 1...4
 window

Parameters:
 <State> ON | OFF
 *RST: OFF

Example: FILT:AWE ON
 Activates the A weighting filter.

Mode: ADEMODO

Manual operation: See ["A Weighted"](#) on page 33

[SENSe:]FILTer<n>:CCIT <State>

This command activates/deactivates the CCITT (CCITT P.53) weighting filter in the specified window.
 For details on the CCITT filter see ["CCITT"](#) on page 32.

Suffix:
 <n> 1...4
 window

Parameters:
 <State> ON | OFF
 *RST: OFF

Example: FILT:CCIT ON
 Activates the CCITT weighting filter.

Mode: ADEMODO

Manual operation: See ["CCITT"](#) on page 32

[SENSe:]FILTer<n>:CCIR[:UNWeighted][:STATe] <State>

This command activates/deactivates the unweighted CCIR filter in the specified window.

For details on the unweighted CCIR filter see "[CCIR Unweighted](#)" on page 32.

Suffix:

<n> 1...4
 window

Parameters:

<State> ON | OFF
 *RST: OFF

Example:

FILT:CCIR:UNW ON
Activates the unweighted CCIR filter.

Mode: ADEMODO

Manual operation: See "[CCIR Unweighted](#)" on page 32

[SENSe:]FILTer<n>:CCIR:WEIGhted[:STATe] <State>

This command activates/deactivates the weighted CCIR filter in the specified window.

For details on the weighted CCIR filter see "[CCIR Weighted](#)" on page 33.

Suffix:

<n> 1...4
 window

Parameters:

<State> ON | OFF
 *RST: OFF

Example:

FILT:CCIR:WEIG ON
Activates the weighted CCIR filter.

Mode: ADEMODO

Manual operation: See "[CCIR Weighted](#)" on page 33

[SENSe:]FILTer<n>:DEMPhasis[:STATe] <State>

This command activates/deactivates the selected deemphasis in the specified window.

For details about deemphasis refer to "[Deemphasis](#)" on page 33.

Suffix:

<n> 1...4
 window

Parameters:

<State> ON | OFF
 *RST: OFF

Example: `FILT:DEMP ON`
Activates the selected deemphasis.

Mode: ADEMODO

Manual operation: See "Deemphasis" on page 33

[SENSe:]FILTeR<n>:DEMPHasis:TCONstant <Deemphasis>

This command selects the deemphasis in the specified window.

For details on deemphasis refer to "Deemphasis" on page 33.

For details on the demodulation bandwidth range refer to "Demod BW" on page 30.

Suffix:
<n> 1...4
window

Parameters:
<Deemphasis> 25 us | 50 us | 75 us | 750 us
*RST: 50 us

Example: `FILT:DEMP:TCON 750us`
Selects the deemphasis for the demodulation bandwidth range from 800 Hz to 4 MHz with a time constant of 750 μ s.

Mode: ADEMODO

Manual operation: See "Deemphasis" on page 33

[SENSe:]FILTeR<n>:HPASs[:STATe] <State>

This command activates/deactivates the selected high pass filter in the specified window.

For details on the high pass filter refer to "High Pass" on page 31.

Suffix:
<n> 1...4
window

Parameters:
<State> ON | OFF
*RST: OFF

Example: `FILT:HPAS ON`
Activates the selected high pass filter.

Mode: ADEMODO

Manual operation: See "High Pass" on page 31
See "None" on page 32

[SENSe:]FILTeR<n>:HPASs:FREQuency <FilterType>

This command selects the high pass filter type in the specified window. For details on filters refer to "High Pass" on page 31.

For details about the demodulation bandwidth range refer to "Demod BW" on page 30.

Suffix:

<n> 1...4
window

Parameters:

<FilterType> Range: 50 to 300
*RST: 300Hz
Default unit: Hz

Example:

FILT:HPAS:FREQ 300Hz

Selects the high pass filter for the demodulation bandwidth range from 800 Hz to 16 MHz.

Mode: ADEMODO

Manual operation: See "High Pass" on page 31

[SENSe:]FILTeR<n>:LPASs[:STATe] <State>

This command activates/deactivates the selected low pass filter in the specified window.

For details on the low pass filter refer to "Low Pass" on page 31.

Suffix:

<n> 1...4
window

Parameters:

<State> ON | OFF
*RST: OFF

Example:

FILT:LPAS ON

Activates the selected low pass filter.

Mode: ADEMODO

Manual operation: See "Low Pass" on page 31

[SENSe:]FILTeR<n>:LPASs:FREQuency[:ABSolute] <FilterType>

This command selects the absolute low pass filter type in the specified window. For details on filters refer to "Low Pass" on page 31.

For details about the demodulation bandwidth range refer to "Demod BW" on page 30.

Suffix:

<n> 1...4
window

Parameters:

<FilterType> 3kHz | 15kHz | 150kHz
 *RST: 15kHz

Example:

FILT:LPAS:FREQ 150kHz

Selects the low pass filter for the demodulation bandwidth range from 400 kHz to 16 MHz.

Mode: ADEMODO

Manual operation: See "Low Pass" on page 31

[SENSe:]FILTEr<n>:LPASs:FREQuency:RELAtive <FilterType>

This command selects the relative low pass filter type in the specified window. For details on filters refer to [Low Pass](#) softkey.

For details about the demodulation bandwidth range refer to "[Demod BW](#)" on page 30.

Suffix:

<n> 1...4
 window

Parameters:

<FilterType> 5PCT | 10PCT | 25PCT
 *RST: 25PCT

Example:

FILT:LPAS:FREQ 25PCT

Selects the low pass filter as 25 % of the demodulation bandwidth.

Mode: ADEMODO

Manual operation: See "Low Pass" on page 31

2.3.6.7 SENSe:FREQuency Subsystem (Analog Demodulation, R&S FSV-K7)

The SENSe:FREQuency subsystem defines the frequency axis of the active display. The frequency axis can either be defined via the start/stop frequency or via the center frequency and span.

[SENSe:]FREQuency:CENTer.....	153
[SENSe:]FREQuency:CENTer:STEP.....	154
[SENSe:]FREQuency:CENTer:STEP:LINK.....	154
[SENSe:]FREQuency:CENTer:STEP:LINK:FACTor.....	155

[SENSe:]FREQuency:CENTer <Frequency>

This command defines the center frequency (frequency domain) or measuring frequency (time domain).

Parameters:

<Frequency> Range: 0 to f_{max}
 *RST: f_{max}/2
 Default unit: Hz
 f_{max} is specified in the data sheet. min span is 10 Hz

Example: `FREQ:CENT 100 MHz`

Manual operation: See "[Center](#)" on page 40

[SENSe:]FREQuency:CENTer:STEP <StepSize>

This command defines the center frequency step size.

Parameters:

<StepSize> Range: 1 to f_{max}
 *RST: 0.1 x
 Default unit: Hz

Example: `FREQ:CENT:STEP 120 MHz`

Manual operation: See "[Manual](#)" on page 41

[SENSe:]FREQuency:CENTer:STEP:LINK <CouplingType>

This command couples and decouples the center frequency step size to the span or the resolution bandwidth.

Parameters:

<CouplingType> **SPAN**
 Couples the step size to the span. Available for measurements in the frequency domain.
 (for RF spectrum result display)

RBW
 Couples the step size to the resolution bandwidth. Available for measurements in the time domain.
 (for all result displays except RF spectrum)

OFF
 Decouples the step size (manual input).
 *RST: SPAN

Example: `FREQ:CENT:STEP:LINK SPAN`

Manual operation: See "[0.1*Span \(RF Spectrum\)](#)" on page 40
 See "[0.1*Demod BW \(AF/RF Time Domain, AF Spectrum\)](#)" on page 41
 See "[0.5*Span \(RF Spectrum\)](#)" on page 41
 See "[0.5*Demod BW \(AF/RF Time Domain, AF Spectrum\)](#)" on page 41
 See "[x*Span \(RF Spectrum\)](#)" on page 41
 See "[x*Demod BW \(AF/RF Time Domain, AF Spectrum\)](#)" on page 41

[SENSe:]FREQuency:CENTer:STEP:LINK:FACTor <Factor>

This command defines a step size factor if the center frequency step size is coupled to the span or the resolution bandwidth.

Parameters:

<Factor> Range: 1 to 100
 *RST: 10
 Default unit: PCT

Example: `FREQ:CENT:STEP:LINK:FACT 20PCT`

Manual operation: See "[0.1*Span \(RF Spectrum\)](#)" on page 40
 See "[0.1*Demod BW \(AF/RF Time Domain, AF Spectrum\)](#)"
 on page 41
 See "[0.5*Span \(RF Spectrum\)](#)" on page 41
 See "[0.5*Demod BW \(AF/RF Time Domain, AF Spectrum\)](#)"
 on page 41
 See "[x*Span \(RF Spectrum\)](#)" on page 41
 See "[x*Demod BW \(AF/RF Time Domain, AF Spectrum\)](#)"
 on page 41

2.3.6.8 SENSE:SWEep Subsystem (Analog Demodulation, R&S FSV-K7)

The SENSE:SWEep subsystem controls the sweep parameters.

[SENSe:]SWEep:COUNT.....	155
[SENSe:]SWEep:EGATE:HOLDoff.....	156
[SENSe:]SWEep:EGATE:POLarity.....	156
[SENSe:]SWEep:EGATE:SOURce.....	156
[SENSe:]SWEep:EGATE:TYPE.....	156
[SENSe:]SWEep:POINts.....	157
[SENSe:]SWEep:TIME.....	157

[SENSe:]SWEep:COUNT <NumberSweeps>

This command defines the number of sweeps started with single sweep, which are used for calculating the average or maximum value. If the values 0 or 1 are set, one sweep is performed.

Parameters:

<NumberSweeps> 0 to 32767
 *RST: 0 (GSM: 200, PHN:1)

Example: `SWE:COUN 64`
 Sets the number of sweeps to 64.
 `INIT:CONT OFF`
 Switches to single sweep mode.
 `INIT;*WAI`
 Starts a sweep and waits for its end.

Manual operation: See "[Sweep Count](#)" on page 56

[SENSe:]SWEep:EGATe:HOLDoff <DelayTime>

This command defines the delay time between the external gate signal and the continuation of the sweep.

Note: Using gate mode "level" (see [SENSe:]SWEep:EGATe:TYPE on page 156) and an IFP trigger (see TRIGger<n>[:SEQUence]:SOURce on page 167), the hold-off time for the IFP trigger is ignored for frequency sweep, FFT sweep, zero span and IQ mode measurements.

Parameters:

<DelayTime> 0 s to 30 s
*RST: 0s

Example: SWE:EGAT:HOLD 100us

[SENSe:]SWEep:EGATe:POLarity <Polarity>

This command determines the polarity of the external gate signal. The setting applies both to the edge of an edge-triggered signal and the level of a level-triggered signal.

Parameters:

<Polarity> POSitive | NEGative
*RST: POSitive

Example: SWE:EGAT:POL POS

Manual operation: See "Trigger Polarity" on page 66

[SENSe:]SWEep:EGATe:SOURce <Source>

This command selects the signal source for gated measurements.

If an IF power signal is used, the gate is opened as soon as a signal at > -20 dBm is detected within the IF path bandwidth (10 MHz).

For details see the "Trigger Source" on page 64 softkey.

Parameters:

<Source> EXTernal | IFPower | VIDeo | RFPower | PSEN
*RST: IFPower

Example: SWE:EGAT:SOUR IFP
Switches the gate source to IF power.

Manual operation: See "RF Power" on page 64
See "IF Power" on page 65

[SENSe:]SWEep:EGATe:TYPE <Type>

This command sets the type of triggering by the external gate signal.

A delay between applying the gate signal and the start of recording measured values can be defined, see [\[SENSe:\]SWEep:EGATe:HOLDoff](#) on page 156.

Parameters:

<Type> LEVEL | EDGE

LEVEL

The gate is level-triggered:

After detection of the gate signal, the gate remains open until the gate signal disappears. The gate opening time cannot be defined with the command [\[SENSe:\]SWEep:EGATe:HOLDoff](#).

Note: Using gating with gate mode "level" and an IFP trigger (see [TRIGger<n>\[:SEQuence\]:SOURce](#) on page 167), the holdoff time for the IFP trigger is ignored for frequency sweep, FFT sweep, zero span and IQ mode measurements.

EDGE

The gate is edge-triggered:

After detection of the set gate signal edge, the gate remains open until the gate delay ([\[SENSe:\]SWEep:EGATe:HOLDoff](#)) has expired.

*RST: EDGE

Example: SWE:EGAT:TYPE EDGE

[SENSe:]SWEep:POINts <NumberPoints>

This command defines the number of measurement points to be collected during one sweep.

Parameters:

<NumberPoints> Range: 101 to 32001
*RST: 691

Example: SWE:POIN 150

Manual operation: See "[Sweep Points](#)" on page 57

[SENSe:]SWEep:TIME <Time>

This command defines the sweep time.

Parameters:

<Time> Refer to [Instrument Functions Analog Demodulation – Sample Rate, Measurement Time and Trigger Offset](#).

2.3.6.9 Other commands in the SENSE subsystem

[SENSe:]AVERage<n>:COUNT <NoMeasurements>

This command defines the number of measurements which contribute to the average value.

Note that continuous averaging is performed after the indicated number has been reached in continuous sweep mode.

In single sweep mode, the sweep is stopped as soon as the indicated number of measurements (sweeps) is reached. Synchronization to the end of the indicated number of measurements is only possible in single sweep mode.

This command has the same effect as the `[SENSe<source>:]SWEep:COUNT` command. In both cases, the number of measurements is defined whether the average calculation is active or not.

The number of measurements applies to all traces in the window.

Suffix:

<n> Selects the measurement window.

Parameters:

<NoMeasurements> 0 to 32767

*RST: 0

Example:

`SWE:CONT OFF`

Switching to single sweep mode.

`AVER:COUN 16`

Sets the number of measurements to 16.

`AVER:STAT ON`

Switches on the calculation of average.

`INIT;*WAI`

Starts the measurement and waits for the end of the 16 sweeps.

[SENSe:]AVERage<n>:TYPE <FunctionType>

This command selects the type of average function.

Suffix:

<n> Selects the measurement window.

Parameters:

<FunctionType> VIDEo | LINear | POWer

VIDeo

The logarithmic power values are averaged.

LINear

The power values are averaged before they are converted to logarithmic values.

POWer

The power level values are converted into unit Watt prior to averaging. After the averaging, the data is converted back into its original unit.

*RST: VIDEo

Example:

`AVER:TYPE LIN`

Switches to linear average calculation.

Manual operation: See ["Lin"](#) on page 62
 See ["Log"](#) on page 62
 See ["Power"](#) on page 62

[SENSe:][WINDow:]DETEctor<trace>[:FUNCTion] <Function>

This command selects the detector for the data acquisition in the selected trace.

Suffix:

<trace> 1...6
 Selects the trace.

<trace> 1...6
 trace

Parameters:

<Function> APEak | NEGative | POSitive | SAMPlE | RMS | AVERAge |
 QPEak

*RST: APEak

For details on detectors refer to [Chapter 2.1.8, "Detector Overview"](#), on page 19.

Example:

DET POS

Sets the detector to "positive peak".

Manual operation: See ["Auto Peak"](#) on page 60
 See ["Positive Peak"](#) on page 60
 See ["Negative Peak"](#) on page 60
 See ["Sample"](#) on page 60
 See ["RMS"](#) on page 60
 See ["Average"](#) on page 61
 See ["Quasipeak"](#) on page 61
 See ["CISPR Average"](#) on page 61
 See ["RMS Average"](#) on page 61

[SENSe:][WINDow:]DETEctor<trace>[:FUNCTion]:AUTO <State>

This command either couples the detector to the current trace setting or turns coupling off.

Suffix:

<trace> 1...6
 trace

Parameters:

<State> ON | OFF

*RST: ON

Example:

DET:AUTO OFF

Manual operation: See ["Auto Select"](#) on page 59

2.3.7 TRACe Subsystem (Analog Demodulation, R&S FSV-K7)

The TRACe subsystem controls access to the instruments internal trace memory.

2.3.7.1	Commands of the TRACe subsystem.....	160
2.3.7.2	Formats for Returned Values: ASCII Format and Binary Format.....	161

2.3.7.1 Commands of the TRACe subsystem

TRACe<n>[:DATA]? <ResultType>

This command returns the current trace data or measurement results. In case of several result displays, you have to use specific parameters to query the results.

For details on saving and recalling data refer to the `MMEMORY` subsystem in the description of the base unit.

Suffix:

<n> 1...4
window; For applications that have only one measurement screen, the suffix is irrelevant.

Query parameters:

<ResultType> TRACE1 | TRACE2 | TRACE3 | TRACE4 | TRACE5 | TRACE6
Selects the type of result to be returned.

TRACE1 | ... | TRACE6

The query returns a list of results with one value for each sweep point in the currently set level unit.
For details see [Table 2-4](#)

Example:

TRAC? TRACE1
Returns the trace data for Trace 1.

Usage:

Query only

Mode:

A, ADEMOD, BT, NF, PHN, TDS

Table 2-4: Results for <TRACe...> ResultTypes

The query returns a list of results with one value for each sweep point in the currently set level unit. By default, the list contains 691 values. The currently used number of sweep points can be determined using `SWE:POIN?`, see [\[SENSe:\]SWEep:POINts](#) on page 157.

`FORMat REAL,32` is used as format for binary transmission, and `FORMat ASCII` for ASCII transmission.

With the auto peak detector, only positive peak values can be read out.

In **IQ Analyzer mode**, if the result display configuration "Real/Imag (I/Q)" is selected, this query returns the I values of each trace point first, then the Q values:

<result>= I₁,I₂,...,I_n, Q₁,Q₂,...,Q_n

FORMat:DEXPort:TRACes <Selection>

This command selects the data to be included in a data export file.

Parameters:

<Selection>

ALL

Selects all active traces for export to an ASCII file.

The <trace> parameter for the `MMEMory:STORe<n>:TRACe` command is ignored.

SINGLE

Only a single trace is selected for export, namely the one specified by the `MMEMory:STORe<n>:TRACe` command.

*RST: SINGLE

Manual operation: See "ASCII Trace Export" on page 63

2.3.7.2 Formats for Returned Values: ASCII Format and Binary Format

ASCII Format (FORMat ASCII)

The command reads out a list of comma separated values (CSV) of the measured values in floating point format.



Reading out data in binary format is quicker than in ASCII format. Thus, binary format is recommended for large amounts of data.

Binary Format (FORMat REAL,32)

The command reads out binary data (Definite Length Block Data according to IEEE 488.2), each measurement value being formatted in 32 Bit IEEE 754 Floating-Point-Format.

Depending on the number of samples to be transferred, 2 different kinds of syntax are used:

For 10^{10} samples:

The schema of the result string is as follows:

#<NoOfDigits><NoOfDataBytes><value1><value2>...<value n>, with

#	Header prefix, 1 byte
<NoOfDigits>	Number of digits of the following number of data bytes (= 4 in the example), 1 byte
<NoOfDataBytes>	Number of following data bytes in decimal form (= 1024 in the example), 1...9 bytes
<Value>	Data values, each one is a 4-byte floating point value

Example:

```
#41024<value1><value2>...<value 256>
```

4: the following number of data bytes has 4 digits

1024: 1024 Bytes of following data; float: 4 Bytes / value => 1024 / 4 = 256 values (128 I and 128 Q values)

<value x>: 4 Byte values, must be interpreted as float

For $\geq 10^{10}$ samples:

The schema of the result string is as follows:

(<NoOfDataBytes>) <value1><value2>...<value n>, with

#	Header prefix, 1 byte
(1 byte
<NoOfDataBytes>	number of following data bytes (= 1024 in the example), 10 bytes
)	1 byte
<Value>	Data values, each one is a 4-byte floating point value

Example:

```
#(1677721600)<value 1><value 2> ... <value 419430400>
```

(1677721600): 1677721600 Bytes of following data; float: 4 Bytes / value ==> 1677721600 / 4 = 419430400 values (200Ms I and 200Ms Q values)

<value x>: 4 Byte values, must be interpreted as float

2.3.8 TRIGger Subsystem (Analog Demodulation, R&S FSV-K7)

The TRIGger subsystem is used to synchronize instrument actions with events. It is thus possible to control and synchronize the start of a sweep.

TRIGger<n>[:SEQuence]:BBPower:HOLDoff.....	163
TRIGger<n>[:SEQuence]:HOLDoff[:TIME].....	163
TRIGger<n>[:SEQuence]:IFPower:HOLDoff.....	163
TRIGger<n>[:SEQuence]:IFPower:HYSteresis.....	164
TRIGger<n>[:SEQuence]:LEVel:AM[:ABSolute].....	164
TRIGger<n>[:SEQuence]:LEVel:AM:RELative.....	164
TRIGger<n>[:SEQuence]:LEVel:BBPower.....	165
TRIGger<n>[:SEQuence]:LEVel:FM.....	165
TRIGger<n>[:SEQuence]:LEVel:IFPower.....	165
TRIGger<n>[:SEQuence]:LEVel:RFPower.....	166
TRIGger<n>[:SEQuence]:LEVel:PM.....	166
TRIGger<n>[:SEQuence]:TIME:RINTerval.....	166
TRIGger<n>[:SEQuence]:LEVel:VIDeo.....	167
TRIGger<n>[:SEQuence]:SLOPe.....	167
TRIGger<n>[:SEQuence]:SOURce.....	167

TRIGger<n>[:SEQuence]:BBPower:HOLDoff <Value>

This command sets the holding time before the next BB power trigger event (for digital input via the R&S Digital I/Q Interface, R&S FSV-B17).

Suffix:

<n> irrelevant

Parameters:

<Value> *RST: 150 ns

Example:

TRIG:SOUR BBP

Sets the baseband power trigger source.

TRIG:BBP:HOLD 200 ns

Sets the holding time to 200 ns.

Mode: all

Manual operation: See ["Trigger Holdoff"](#) on page 67

TRIGger<n>[:SEQuence]:HOLDoff[:TIME] <Delay>

This command defines the length of the trigger delay.

A negative delay time (pretrigger) can be set in zero span only.

Suffix:

<n> irrelevant

Parameters:

<Delay> Range: zero span: -sweptime (see data sheet) to 30 s;
span: 0 to 30 s

*RST: 0 s

Example:

TRIG:HOLD 500us

Manual operation: See ["Trigger Offset"](#) on page 66

See ["Trigger Offset"](#) on page 219

TRIGger<n>[:SEQuence]:IFPower:HOLDoff <Value>

This command sets the holding time before the next IF power trigger event.

Suffix:

<n> irrelevant

Parameters:

<Value> *RST: 150 ns

Example:

TRIG:SOUR IFP

Sets the IF power trigger source.

TRIG:IFP:HOLD 200 ns

Sets the holding time to 200 ns.

Manual operation: See ["Trigger Holdoff"](#) on page 67

TRIGger<n>[:SEQuence]:IFPower:HYSTerisis <Value>

This command sets the limit that the hysteresis value for the IF power trigger has to fall below in order to trigger the next measurement.

Suffix:

<n> irrelevant

Parameters:

<Value> *RST: 3 dB

Example:

TRIG:SOUR IFP

Sets the IF power trigger source.

TRIG:IFP:HYST 10DB

Sets the hysteresis limit value.

Manual operation: See ["Trigger Hysteresis"](#) on page 67

TRIGger<n>[:SEQuence]:LEVel:AM[:ABSolute] <Level>

The command sets the level when RF power signals are used as trigger source.

For triggering with AF, AM, AMRelative, FM, and PM trigger sources to be successful, the measurement time must cover at least 5 periods of the audio signal.

Suffix:

n irrelevant

Parameters:

<Level> Range: -100 to +30
*RST: -20 dBm
Default unit: dBm

Example:

TRIG:LEV:AM -30 dBm

Sets the RF power signal trigger threshold to -30 dBm

Mode: ADEMODO

Manual operation: See ["RF"](#) on page 218

TRIGger<n>[:SEQuence]:LEVel:AM:RELative <Level>

The command sets the level when AM-modulated signals are used as trigger source.

For triggering with AF, AM, AMRelative, FM, and PM trigger sources to be successful, the measurement time must cover at least 5 periods of the audio signal.

Suffix:

n irrelevant

Parameters:

<Level> Range: -100 to +100
*RST: 0 %
Default unit: %

Example: TRIG:LEV:AM:REL -20 %
Sets the AM trigger threshold to -20 %

Mode: ADEM0D

TRIGger<n>[:SEQuence]:LEVel:BBPower <Level>

This command sets the level of the baseband power trigger source (for digital input via the R&S Digital I/Q Interface, R&S FSV-B17).

Suffix:
<n> irrelevant

Parameters:
<Level> Range: -50 dBm to +20 dBm
*RST: -20 DBM

Example: TRIG:LEV:BB -30DBM

Mode: All

Manual operation: See "[Trigger Level](#)" on page 66

TRIGger<n>[:SEQuence]:LEVel:FM <Level>

The command sets the level when FM-modulated signals are used as trigger source.

For triggering with AF, AM, AMRelative, FM, and PM trigger sources to be successful, the measurement time must cover at least 5 periods of the audio signal.

Suffix:
n irrelevant

Parameters:
<Level> Range: -10 to +10
*RST: 0 Hz
Default unit: MHz

Example: TRIG:LEV:FM 10 kHz
Sets the FM trigger threshold to 10 kHz

Mode: ADEM0D

TRIGger<n>[:SEQuence]:LEVel:IFPower <TriggerLevel>

This command defines the power level at the third intermediate frequency that must be exceeded to cause a trigger event. Note that any RF attenuation or preamplification is considered when the trigger level is analyzed. If defined, a reference level offset is also considered.

Suffix:
<n> irrelevant

Parameters:
<TriggerLevel> *RST: -20 dBm

Example: TRIG:LEV:IFP -30DBM

Manual operation: See "Trigger Level" on page 66

TRIGger<n>[:SEQuence]:LEVel:RFPower <TriggerLevel>

This command defines the power level at the third intermediate frequency that must be exceeded to cause a trigger event. Note that any RF attenuation or preamplification is considered when the trigger level is analyzed. If defined, a reference level offset is also considered.

Suffix:

<n> irrelevant

Parameters:

<TriggerLevel> *RST: -20 dBm

Example: TRIG:LEV:RFP -30dBm

TRIGger<n>[:SEQuence]:LEVel:PM <Level>

The command sets the level when PM-modulated signals are used as trigger source.

For triggering with AF, AM, AMRelative, FM, and PM trigger sources to be successful, the measurement time must cover at least 5 periods of the audio signal.

Suffix:

n irrelevant

Parameters:

<Level> Range: -1000 to +1000
*RST: 0 RAD
Default unit: RAD | DEG

Example: TRIG:LEV:PM 1.2 RAD
Sets the PM trigger threshold to 1.2 rad

Mode: ADEMODO

TRIGger<n>[:SEQuence]:TIME:RINterval <Interval>

This command sets the repetition interval for the time trigger source.

Suffix:

<n> irrelevant

Parameters:

<Interval> 2.0 ms to 5000
*RST: 1.0

Example: TRIG:SOUR TIME
Selects the time trigger input for triggering.
TRIG:TIME:RINT 50
The sweep starts every 50 s.

Mode: All

Manual operation: See "[Repetition Interval](#)" on page 67

TRIGger<n>[:SEQuence]:LEVel:VIDeo <Value>

This command sets the level of the video trigger source.

Suffix:

<n> irrelevant

Parameters:

<Value> 0 to 100 PCT
*RST: 50 PCT

Example: TRIG:LEV:VID 50PCT

TRIGger<n>[:SEQuence]:SLOPe <Type>

This command selects the slope of the trigger signal. The selected trigger slope applies to all trigger signal sources.

Suffix:

<n> irrelevant

Parameters:

<Type> POSitive | NEGative
*RST: POSitive

Example: TRIG:SLOP NEG

Manual operation: See "[Trigger Polarity](#)" on page 66

TRIGger<n>[:SEQuence]:SOURce <Source>

This command selects the trigger source.

For triggering with AF, AM, AMRelative, FM, and PM trigger sources to be successful, the measurement time must cover at least 5 periods of the audio signal. For details on trigger modes refer to the [Trigger Source](#) softkey.

IF power and RF power triggers are not available together with the bandwidth extension option R&S FSV-B160.

For details on trigger modes refer to the "Trg/Gate Source" softkey in the base unit description.

Suffix:

<n> irrelevant

Parameters:

<Source> **IMMediate**
Free Run

EXtern

External trigger

IFPower

Power trigger at the second intermediate frequency

TIME

Time interval

GP0 | GP1 | GP2 | GP3 | GP4 | GP5

For I/Q Analyzer or AnalogDemod mode only:

Defines triggering of the measurement directly via the LVDS connector. The parameter specifies which general purpose bit (0 to 5) will provide the trigger data.

This trigger mode is available for input from the R&S Digital I/Q Interface (option R&S FSV-B17) only.

The assignment of the general purpose bits used by the Digital IQ trigger to the LVDS connector pins is provided in [Table 2-5](#)

VIDeo

Video mode is only available in the time domain and only in Spectrum mode.

BBPower

Baseband power (for digital input via the R&S Digital I/Q Interface, R&S FSV-B17)

PSEN

External power sensor (requires R&S FSV-K9 option)

AF

AF power signal

FM

FM power signal

AM

corresponds to the RF power signal

AMRelative

corresponds to the AM signal

PM

PM power signal

*RST: IMMEDIATE

Example:

```
TRIG:SOUR EXT
```

Selects the external trigger input as source of the trigger signal

Manual operation: See "Trigger Source" on page 64
 See "Free Run" on page 64
 See "External" on page 64
 See "RF Power" on page 64
 See "IF Power" on page 65
 See "FM" on page 65
 See "AM" on page 65
 See "PM" on page 65
 See "RF" on page 65
 See "Time" on page 66
 See "Trigger Source" on page 216

Table 2-5: Assignment of general purpose bits to LVDS connector pins

Bit	LVDS pin
GP0	SDATA4_P - Trigger1
GP1	SDATA4_P - Trigger2
GP2	SDATA0_P - Reserve1
GP3	SDATA4_P - Reserve2
GP4	SDATA0_P - Marker1
GP5	SDATA4_P - Marker2

2.3.9 UNIT Subsystem (Analog Demodulation, R&S FSV-K7)

UNIT:ANGLE <Unit>

This command selects the unit for angles (e.g. for PM display).

The unit is defined globally for all windows.

Suffix:

<n> irrelevant

Parameters:

<Unit> DEG | RAD
 *RST: RAD

Example: UNIT:ANGL DEG

Mode: ADEMODO, SFM

UNIT:POWER <Unit>

This command selects the unit for power.

The unit is defined globally for all windows.

Suffix:

<n> irrelevant

Parameters:

<Unit> DBM | V | A | W | DBPW | WATT | DBUV | DBMV | VOLT |
 DBUA | AMPere
 *RST: dBm

Example:

UNIT:POW DBM
 Sets the power unit to dBm.

Mode:

A, ADEMODO, SFM, SPECM

UNIT:THD <Mode>

Selects the unit for THD measurements.

Parameters:

<Mode> DB | PCT
 *RST: DB

Example:

UNIT:THD PCT

Mode:

ADEMODO, SFM

Manual operation:

See "Phase Unit (Rad/Deg)" on page 35
 See "THD Unit (% / DB)" on page 35

2.3.10 Other Commands Referenced in this Manual

2.3.10.1 CALCulate:DELTamarker Subsystem (Analog Demodulation, R&S FSV-K7)

The CALCulate:DELTamarker subsystem controls the delta marker functions of the instrument.

CALCulate<n>:DELTamarker<m>:FUNCTION:FIXed:RPOint:MAXimum[:PEAK].....	170
CALCulate<n>:DELTamarker<m>:FUNCTION:FIXed:RPOint:X.....	171
CALCulate<n>:DELTamarker<m>:FUNCTION:FIXed:RPOint:Y.....	171
CALCulate<n>:DELTamarker<m>:FUNCTION:FIXed[:STATE].....	172
CALCulate<n>:DELTamarker<m>:FUNCTION:PNOise[:STATE].....	172
CALCulate<n>:DELTamarker<m>:FUNCTION:PNOise:AUTO.....	173
CALCulate<n>:DELTamarker<m>:LINK.....	173
CALCulate<n>:DELTamarker<m>:MREF.....	174
CALCulate<n>:DELTamarker<m>[:STATE].....	174
CALCulate<n>:DELTamarker<m>:TRACe.....	174
CALCulate<n>:DELTamarker<m>:X.....	175
CALCulate<n>:DELTamarker<m>:X:RELative?.....	175
CALCulate<n>:DELTamarker<m>:Y?.....	176

CALCulate<n>:DELTamarker<m>:FUNCTION:FIXed:RPOint:MAXimum[:PEAK]

This command moves the fixed reference marker to the peak power.

When measuring the phase noise, the command defines a new reference point level for delta marker 2.

Suffix:

<n> Selects the measurement window.

<m> Selects the marker.

Example:

```
CALC:DELT:FUNC:FIX:RPO:MAX
```

Sets the reference point level for delta markers to the peak of the selected trace.

Usage:

Event

Manual operation: See "[Peak Search](#)" on page 73

CALCulate<n>:DELTamarker<m>:FUNctioN:FIXed:RPOint:X <Reference>

This command defines the horizontal position of the fixed delta marker reference point. The coordinates of the reference may be anywhere in the diagram.

When measuring the phase noise, the command defines the frequency reference for delta marker 2.

Suffix:

<n> Selects the measurement window.

<m> Selects the marker.

Parameters:

<Reference> Numeric value that defines the horizontal position of the reference.

For frequency domain measurements, it is a frequency in Hz.

For time domain measurements, it is a point in time in s.

*RST: Fixed reference: OFF

Example:

```
CALC:DELT:FUNC:FIX:RPO:X 128 MHz
```

Sets the frequency reference to 128 MHz.

Manual operation: See "[Ref Point Frequency \(span > 0\)/Ref Point Time \(zero span\)](#)" on page 73

CALCulate<n>:DELTamarker<m>:FUNctioN:FIXed:RPOint:Y <RefPointLevel>

This command defines the vertical position of the fixed delta marker reference point. The coordinates of the reference may be anywhere in the diagram.

When measuring the phase noise, the command defines the level reference for delta marker 2.

Suffix:

<n> Selects the measurement window.

<m> Selects the marker.

Parameters:

<RefPointLevel> Numeric value that defines the vertical position of the reference. The unit and value range is variable.

*RST: Fixed reference: OFF

Example:

CALC:DELT:FUNC:FIX:RPO:Y -10dBm

Sets the reference point level for delta markers to -10 dBm.

Manual operation: See "[Ref Point Level](#)" on page 72

CALCulate<n>:DELTamarker<m>:FUNCTION:FIXed[:STATe] <State>

This command switches the relative measurement to a fixed reference value on or off. Marker 1 is activated previously and a peak search is performed, if necessary. If marker 1 is activated, its position becomes the reference point for the measurement. The reference point can then be modified with the [CALCulate<n>:DELTamarker<m>:FUNCTION:FIXed:RPOint:X](#) commands and [CALCulate<n>:DELTamarker<m>:FUNCTION:FIXed:RPOint:Y](#) independently of the position of marker 1 and of a trace. It applies to all delta markers as long as the function is active.

Suffix:

<n> Selects the measurement window.

<m> Selects the marker.

Parameters:

<State> ON | OFF

*RST: OFF

Example:

CALC:DELT:FUNC:FIX ON

Switches on the measurement with fixed reference value for all delta markers.

CALC:DELT:FUNC:FIX:RPO:X 128 MHZ

Sets the frequency reference to 128 MHz.

CALC:DELT:FUNC:FIX:RPO:Y 30 DBM

Sets the reference level to +30 dBm.

Manual operation: See "[Ref. Fixed On/Off](#)" on page 72

CALCulate<n>:DELTamarker<m>:FUNCTION:PNOise[:STATe] <State>

This command turns the phase noise measurement at the delta marker position on and off.

The correction values for the bandwidth and the log amplifier are taken into account in the measurement.

The reference marker for phase noise measurements is either a normal marker or a fixed reference. If necessary, the command turns on the reference marker

A fixed reference point can be modified with the [CALCulate<n>:DELTamarker<m>:FUNCTION:FIXed:RPOint:X](#) and [CALCulate<n>:DELTamarker<m>:FUNCTION:FIXed:RPOint:Y](#) commands independent of the position of marker 1 and of a trace.

Remote Commands of the Analog Demodulation (R&S FSV-K7)

Suffix:

<n> Selects the measurement window.

<m> irrelevant

Note: marker 2 is always the deltamarker for phase noise measurement results.

Parameters:

<State> ON | OFF

*RST: OFF

Example:

```
CALC:DELT:FUNC:PNO ON
```

Switches on the phase-noise measurement with all delta markers.

```
CALC:DELT:FUNC:FIX:RPO:X 128 MHZ
```

Sets the frequency reference to 128 MHz.

```
CALC:DELT:FUNC:FIX:RPO:Y 30 DBM
```

Sets the reference level to +30 dBm

CALCulate<n>:DELTamarker<m>:FUNCTION:PNOise:AUTO <State>

This command turns an automatic peak search for the fixed reference marker at the end of a sweep on and off.

Suffix:

<n> Selects the measurement window.

<m> irrelevant

Parameters:

<State> ON | OFF

*RST: OFF

Example:

```
CALC:DELT:FUNC:PNO:AUTO ON
```

Activates an automatic peak search for the reference marker in a phase-noise measurement.

CALCulate<n>:DELTamarker<m>:LINK <State>

This command links delta marker 1 to marker 1.

If you change the horizontal position of the marker, so does the delta marker.

Suffix:

<n> Selects the measurement window.

<m> 1
irrelevant

Parameters:

<State> ON | OFF

*RST: OFF

Example:

```
CALC:DELT:LINK ON
```

Manual operation: See ["Link Mkr1 and Delta1"](#) on page 71

CALCulate<n>:DELTamarker<m>:MREF <RefMarkerNo>

This command defines the reference marker for a delta marker other than marker 1. The reference may be another marker or the fixed reference.

Suffix:

<n> Selects the measurement window.
 <m> Selects the marker.

Parameters:

<RefMarkerNo> **1 ... 16**
 Selects markers 1 to 16 as the reference.

FIXed

Selects the fixed reference as the reference.

Example:

`CALC:DELT3:MREF 2`
 Specifies that the values of delta marker 3 are relative to marker 2.

Manual operation: See ["Marker Wizard"](#) on page 68

CALCulate<n>:DELTamarker<m>[:STATe] <State>

This command turns delta markers on and off. If the corresponding marker was a normal marker, it is turned into a delta marker. No suffix at DELTmarker turns on delta marker 1.

Suffix:

<n> Selects the measurement window.
 <m> Selects the marker.

Parameters:

<State> ON | OFF
 *RST: OFF

Example:

`CALC:DELT1 ON`
 Switches marker 1 to delta marker mode.

Manual operation: See ["Marker 1 / Marker 2 / Marker 3 / ... Marker 16, / Marker Norm/Delta"](#) on page 68
 See ["Marker Wizard"](#) on page 68

CALCulate<n>:DELTamarker<m>:TRACe <TraceNumber>

This command selects the trace a delta marker is positioned on. The corresponding trace must have a trace mode other than "Blank".

Suffix:	
<n>	Selects the measurement window.
<m>	Selects the marker.
Parameters:	
<TraceNumber>	1 ... 6 Trace number the marker is positioned on.
Example:	<code>CALC:DELT3:TRAC 2</code> Assigns delta marker 3 to trace 2.
Manual operation:	See " Marker Wizard " on page 68

CALCulate<n>:DELTamarker<m>:X <Position>

This command positions a delta marker on a particular coordinate on the x-axis.

The position is an absolute value.

Suffix:	
<n>	Selects the measurement window.
<m>	Selects the marker.
Parameters:	
<Position>	0 to maximum frequency or sweep time
Example:	<code>CALC:DELT:X?</code> Outputs the absolute frequency/time of delta marker 1.
Manual operation:	See " Marker 1 / Marker 2 / Marker 3 / ... Marker 16, / Marker Norm/Delta " on page 68

CALCulate<n>:DELTamarker<m>:X:RELative?

This command queries the x-value of the selected delta marker relative to marker 1 or to the reference position (for `CALC:DELT:FUNC:FIX:STAT ON`). The command activates the corresponding delta marker, if necessary.

Suffix:	
<n>	Selects the measurement window.
<m>	Selects the marker.
Example:	<code>CALC:DELT3:X:REL?</code> Outputs the frequency of delta marker 3 relative to marker 1 or relative to the reference position.
Usage:	Query only
Manual operation:	See " Marker 1 / Marker 2 / Marker 3 / ... Marker 16, / Marker Norm/Delta " on page 68

CALCulate<n>:DELTamarker<m>:Y?

This command queries the measured value of a delta marker. The corresponding delta marker is activated, if necessary. The output is always a relative value referred to marker 1 or to the reference position (reference fixed active).

To obtain a correct query result, a complete sweep with synchronization to the sweep end must be performed between the activation of the delta marker and the query of the y value. This is only possible in single sweep mode.

Depending on the unit defined with `CALC:UNIT:POW` or on the activated measuring functions, the query result is output in the units below:

Table 2-6: Analog demodulation measurements

Parameter, measuring function or result display	Output unit
AM result display (R&S FSV-K7)	% (lin) dB (log)
FM result display (R&S FSV-K7)	Hz (lin) dB (log)
PM result display (R&S FSV-K7)	rad deg (lin) dB (log)
RF result display (R&S FSV-K7)	dB (Range Log or Range Linear %) % (Range Linear %)

Suffix:

<n> Selects the measurement window.

<m> Selects the marker.

Example:

```
INIT:CONT OFF
Switches to single sweep mode.
INIT;*WAI
Starts a sweep and waits for its end.
CALC:DELT2 ON
Switches on delta marker 2.
CALC:DELT2:Y?
Outputs measurement value of delta marker 2.
```

Usage: Query only

Manual operation: See "[Marker 1 / Marker 2 / Marker 3 / ... Marker 16, / Marker Norm/Delta](#)" on page 68

2.3.10.2 INPut subsystem

INPut:ATTenuation	177
INPut:ATTenuation:AUTO	177
INPut:COUPling	178
INPut:DIQ:CDEvice	178
INPut:DIQ:RANGe:COUPling	179

INPut:DIQ:RANGe[:UPPer].....	179
INPut:DIQ:RANGe[:UPPer]:UNIT.....	180
INPut:DIQ:SRATe.....	180
INPut:EATT.....	181
INPut:EATT:AUTO.....	181
INPut:GAIN:STATe.....	181
INPut:IMPedance.....	182
INPut:SElect.....	182

INPut:ATTenuation <Value>

This command programs the input attenuator. To protect the input mixer against damage from overloads, the setting 0 dB can be obtained by entering numerals, not by using the DOWN command.

The RF attenuation can be set in 5 dB steps (R&S FSV with option R&S FSV-B25 or R&S FSVA: 1 dB steps). The range is specified in the data sheet. If the current reference level cannot be set for the set RF attenuation, the reference level is adjusted accordingly.

In the default state with "Spectrum" mode, the attenuation set on the step attenuator is coupled to the reference level of the instrument. If the attenuation is programmed directly, the coupling to the reference level is switched off.

This function is not available if the R&S Digital I/Q Interface (R&S FSV-B17) is active.

Parameters:

<Value> *RST: 10 dB (AUTO is set to ON)

Example:

INP:ATT 30dB

Sets the attenuation on the attenuator to 30 dB and switches off the coupling to the reference level.

Mode: all

Manual operation: See "[RF Atten Manual/Mech Att Manual](#)" on page 46

INPut:ATTenuation:AUTO <State>

This command automatically couples the input attenuation to the reference level (state ON) or switches the input attenuation to manual entry (state OFF).

This function is not available if the R&S Digital I/Q Interface (R&S FSV-B17) is active.

Parameters:

<State> ON | OFF

*RST: ON

Example:

INP:ATT:AUTO ON

Couples the attenuation set on the attenuator to the reference level.

Manual operation: See "[RF Atten Auto/Mech Att Auto](#)" on page 47

INPut:COUPling <CouplingType>

Toggles the RF input of the R&S FSV-A/FSV between AC and DC coupling.

This function is not available if the R&S Digital I/Q Interface (R&S FSV-B17) is active.

Parameters:

<CouplingType> AC | DC
*RST: AC

Example: INP:COUP DC

Manual operation: See "[Input \(AC/DC\)](#)" on page 48

INPut:DIQ:CDEvice

This command queries the current configuration and the status of the digital baseband input from the optional R&S Digital I/Q Interface (option R&S FSV-B17).

For details see the section "Interface Status Information" for the R&S Digital I/Q Interface (R&S FSV-B17) in the description of the base unit.

Return values:

<ConnState> Defines whether a device is connected or not.
0
No device is connected.
1
A device is connected.

<DeviceName> Device ID of the connected device

<SerialNumber> Serial number of the connected device

<PortName> Port name used by the connected device

<SampleRate> Maximum or currently used sampling rate of the connected device in Hz (depends on the used connection protocol version; indicated by <SampleRateType> parameter)

<MaxTransferRate> Maximum data transfer rate of the connected device in Hz

<ConnProtState> State of the connection protocol which is used to identify the connected device.
Not Started
Has to be Started
Started
Passed
Failed
Done

<PRBSTestState> State of the PRBS test.
Not Started
Has to be Started

	Started
	Passed
	Failed
	Done
<SampleRateType>	0 Maximum sampling rate is displayed
	1 Current sampling rate is displayed
<Placeholder>	for future use; currently "0"
Example:	INP:DIQ:CDEV? Result: 1, SMU200A, 103634, Out A, 70000000, 100000000, Passed, Not Started, 0, 0
Mode:	IQ, VSA, EVDO, CDMA, WCDMA, GSM, ADEMODO, TDS
Manual operation:	See "Connected Device" on page 78 See "Digital IQ Info" on page 80

INPut:DIQ:RANGe:COUPling <State>

If enabled, the reference level for digital input is adjusted to the full scale level automatically if the fullscale level changes.

This command is only available if the optional R&S Digital I/Q Interface (option R&S FSV-B17) is installed.

For details see the R&S Digital I/Q Interface (R&S FSV-B17) description of the base unit.

Parameters:

<State> ON | OFF
*RST: OFF

Example: INP:DIQ:RANG:COUP OFF

Mode: IQ, VSA, EVDO, CDMA, WCDMA, GSM, ADEMODO, TDS

Manual operation: See ["Adjust Reference Level to Full Scale Level"](#) on page 78

INPut:DIQ:RANGe[:UPPer] <Level>

Defines or queries the "Full Scale Level", i.e. the level that should correspond to an I/Q sample with the magnitude "1".

It can be defined either in dBm or Volt (see ["Full Scale Level"](#) on page 78).

This command is only available if the optional R&S Digital I/Q Interface (option R&S FSV-B17) is installed.

For details see the R&S Digital I/Q Interface (R&S FSV-B17) description of the base unit.

Remote Commands of the Analog Demodulation (R&S FSV-K7)

Parameters:

<Level> <numeric value>
 Range: 70.711 nV to 7.071 V
 *RST: 1 V

Example: INP:DIQ:RANG 1V

Mode: A, IQ, NF, TDS, VSA, CDMA, EVDO, WCDMA, ADEMODO, GSM, OFDM, OFDMA/WiBro, WLAN

Manual operation: See "[Full Scale Level](#)" on page 78

INPut:DIQ:RANGe[:UPPer]:UNIT <Unit>

Defines the unit of the full scale level (see "[Level Unit](#)" on page 78). The availability of units depends on the measurement application you are using.

This command is only available if the optional R&S Digital I/Q Interface (option R&S FSV-B17) is installed.

For details see the R&S Digital I/Q Interface (R&S FSV-B17) description of the base unit.

Parameters:

<Level> V | dBm | dBpW | W | dBmV | dBuV | dBuA | A
 *RST: Volt

Example: INP:DIQ:RANG:UNIT A

Mode: IQ, VSA, EVDO, CDMA, WCDMA, GSM, ADEMODO, TDS

Manual operation: See "[Level Unit](#)" on page 78

INPut:DIQ:SRATe <SampleRate>

This command specifies or queries the sample rate of the input signal from the R&S Digital I/Q Interface (see "[Input Sample Rate](#)" on page 78).

Note: the final user sample rate of the R&S FSV-A/FSV may differ and is defined using `SENSe:ADEM:SRATe` (see [`SENSe:`] `ADEMod:SRATe?` on page 143).

This command is only available if the optional R&S Digital I/Q Interface (option R&S FSV-B17) is installed.

For details see the R&S Digital I/Q Interface (R&S FSV-B17) description of the base unit.

Parameters:

<SampleRate> Range: 1 Hz to 10 GHz
 *RST: 32 MHz

Example: INP:DIQ:SRAT 200 MHz

Mode: A, IQ, NF, TDS, VSA, CDMA, EVDO, WCDMA, ADEMODO, GSM, OFDM, OFDMA/WiBro, WLAN

Manual operation: See ["Input Sample Rate"](#) on page 78

INPut:EATT <Attenuation>

This command defines the electronic attenuation.

If necessary, the command also turns the electronic attenuator on.

This command is only available with option R&S FSV-B25, but not if R&S FSV-B17 is active.

The attenuation can be varied in 1 dB steps from 0 to 25 dB. Other entries are rounded to the next lower integer value.

If the defined reference level cannot be set for the given RF attenuation, the reference level is adjusted accordingly and the warning "Limit reached" is output.

Parameters:

<Attenuation> 0...25
 *RST: 0 dB (OFF)

Example: INP1:EATT 10 dB

Mode: all

Manual operation: See ["EI Atten Mode \(Auto/Man\)"](#) on page 47

INPut:EATT:AUTO <State>

This command switches the automatic behaviour of the electronic attenuator on or off. If activated, electronic attenuation is used to reduce the operation of the mechanical attenuation whenever possible.

This command is only available with option R&S FSV-B25, but not if R&S FSV-B17 is active.

Parameters:

<State> ON | OFF
 *RST: ON

Example: INP1:EATT:AUTO OFF

Mode: all

Manual operation: See ["EI Atten On/Off"](#) on page 47
 See ["EI Atten Mode \(Auto/Man\)"](#) on page 47

INPut:GAIN:STATe <State>

This command turns the preamplifier on and off. (For the exact amplification value, see the data sheet).

With option R&S FSV-B22, the preamplifier only has an effect below 7 GHz.

With option R&S FSV-B24, the amplifier applies to the entire frequency range.

This command is not available when using R&S Digital I/Q Interface (R&S FSV-B17).

Parameters:

<State> ON | OFF
*RST: OFF

Example:

INP:GAIN:STAT ON
Turns the preamplifier on.

Manual operation: See "[Preamp On/Off](#)" on page 46

INPut:IMPedance <Impedance>

This command selects the nominal input impedance.

75 Ω should be selected if the 50 Ω input impedance is transformed to a higher impedance using a 75 Ω adapter of the RAZ type (= 25 Ω in series to the input impedance of the instrument). The correction value in this case is 1.76 dB = 10 log (75 Ω /50 Ω).

This function is not available if the R&S Digital I/Q Interface (R&S FSV-B17) is active.

Parameters:

<Impedance> 50 | 75
*RST: 50 Ω

Example:

INP:IMP 75

Manual operation: See "[Input 50 \$\Omega\$ /75 \$\Omega\$](#) " on page 49

INPut:SElect <Source>

This command selects the signal source for measurements.

Parameters:

<Source> **RF**
Radio Frequency ("RF INPUT" connector)
DIQ
Digital IQ (only available with R&S Digital I/Q Interface, option R&S FSV-B17)
*RST: RF

Example:

INP:SEL RF

Mode:

A, IQ, NF, TDS, VSA, CDMA, EVDO, WCDMA, ADEMODO, GSM, OFDM, OFDMA/WiBro, WLAN

Manual operation: See "[Input Path](#)" on page 77

2.3.10.3 MMEMory subsystem

MMEMory:STORe<n>:LIST <FileName>

This command stores the current list evaluation results in a <file name>.dat file. The file consists of a data section containing the list evaluation results.

Suffix:

<n> irrelevant

Parameters:

<FileName> <file name>

Example:

MMEM:STOR:LIST 'test'

Stores the current list evaluation results in the test.dat file.

Manual operation: See "ASCII File Export" on page 75

MMEMory:STORe<n>:TRACe <Trace>, <FileName>

This command stores the selected trace in the specified window in a file with ASCII format. The file format is described in [Chapter 2.1.11, "ASCII File Export Format"](#), on page 23

The decimal separator (decimal point or comma) for floating-point numerals contained in the file is defined with the `FORMat:DEXPort:DSEParator` command (see [FORMat:DEXPort:DSEParator](#) on page 185).

Suffix:

<n> window; For applications that do not have more than 1 measurement window, the suffix <n> is irrelevant.

Parameters:

<Trace> 1 to 6
Selected a trace.

<FileName> DOS file name
The file name includes indication of the path and the drive name. Indication of the path complies with DOS conventions.

Example:

MMEM:STOR:TRAC 3, 'TEST.ASC'

Stores trace 3 in the file TEST.ASC.

Manual operation: See "ASCII Trace Export" on page 63

2.3.10.4 OUTPut subsystem

OUTPut:DIQ <State>

If enabled, the captured IQ data is output to the R&S Digital I/Q Interface in a continuous stream. This function requires the LVDS interface option (R&S FSV-B17).

Digital input and digital output cannot be used simultaneously.

Parameters:
 <State> **ON | OFF**
 *RST: OFF

Example: OUTP:DIQ ON

Mode: ADEMOD, IQ, VSA

OUTPut:IF[:SOURce] <Source>

This command selects the source of the IF output.

Parameters:
 <Source> **IF**
 Outputs the intermediate frequency.
 VIDeo
 Outputs the video signal (200 mV).
 *RST: IF

Example: OUTP:IF VID
 Selects the video signal for the IF output connector.

Manual operation: See "[Video Output](#)" on page 76

OUTPut:TRIGger <PortLevel>

This command selects level of the Trigger Out port. Thus, you can trigger an additional device via the external trigger port, for example.

Parameters:
 <PortLevel> **LOW | HIGH**
 *RST: LOW

Example: OUTP:TRIG HIGH

Manual operation: See "[Trigger Out](#)" on page 77

2.3.10.5 Other Commands

FORMat[:DATA] <Format>

This command selects the data format for the data transmitted from the R&S FSVA/FSV to the controlling computer. It is used for the transmission of trace data. The data format of trace data received by the instrument is automatically recognized, regardless of the format which is programmed.

(See also [TRACe<n>\[:DATA\]?](#) on page 160).

Parameters:
 <Format> **ASCIi**
 ASCII data are transmitted in plain text, separated by commas.

REAL

REAL data are transmitted as 32-bit IEEE 754 floating-point numbers in the "definite length block format".

*RST: ASCII

Example: FORM REAL, 32
FORM ASC

FORMat:DEXPort:DSEParator <Separator>

This command defines which decimal separator (decimal point or comma) is to be used for outputting measurement data to the file in ASCII format. Different languages of evaluation programs (e.g. MS-Excel) can thus be supported.

Parameters:

<Separator> POINT | COMMA
*RST: (factory setting is POINT; *RST does not affect setting)

Example: FORM:DEXP:DSEP POIN
Sets the decimal point as separator.

Manual operation: See "[ASCII Trace Export](#)" on page 63
See "[Decim Sep](#)" on page 63
See "[ASCII File Export](#)" on page 75

DIAGnostic<n>:SERVice:NSOource <State>

This command switches the 28 V supply of the noise source on the front panel on or off.

Suffix:

<n> irrelevant

Parameters:

<State> ON | OFF
*RST: OFF

Example: DIAG:SERV:NSO ON

Manual operation: See "[Noise Source](#)" on page 76

INITiate<n>:CONMeas

This command restarts a measurement that has been stopped in single sweep mode. The measurement is restarted at the first sweep point.

As opposed to `INITiate<n>[:IMMediate]`, this command does not reset traces in maxhold, minhold or average mode. Therefore it can be used to continue measurements using max hold or averaging functions.

In single sweep mode, you can synchronize to the end of the measurement with *OPC, *OPC? or *WAI. In continuous sweep mode, synchronization to the end of the measurement is not possible. Thus, it is not recommended that you use continuous sweep mode in remote control, as results like trace data or markers are only valid after a single sweep end synchronization.

Suffix:

<n> irrelevant

Example:

```
INIT:CONT OFF
```

Switches to single sweep mode.

```
DISP:WIND:TRAC:MODE AVER
```

Switches on trace averaging.

```
SWE:COUN 20
```

Setting the sweep counter to 20 sweeps.

```
INIT;*WAI
```

Starts the measurement and waits for the end of the 20 sweeps.

```
INIT:CONM;*WAI
```

Continues the measurement (next 20 sequences) and waits for the end.

Manual operation: See ["Continue Single Sweep"](#) on page 56

INITiate<n>:CONTInuous <State>

This command determines whether the trigger system is continuously initiated (continuous) or performs single measurements (single).

The sweep is started immediately.

Suffix:

<n> irrelevant

Parameters:

<State> ON | OFF

```
*RST: ON
```

Example:

```
INIT:CONT OFF
```

Switches the sequence to single sweep.

```
INIT:CONT ON
```

Switches the sequence to continuous sweep.

Mode:

all

Manual operation: See ["Continuous Sweep"](#) on page 56
See ["Single Sweep"](#) on page 56

INITiate<n>[:IMMEDIATE]

The command initiates a new measurement sequence.

With sweep count > 0 or average count > 0, this means a restart of the indicated number of measurements. With trace functions MAXHold, MINHold and AVERage, the previous results are reset on restarting the measurement.

In single sweep mode, you can synchronize to the end of the measurement with *OPC, *OPC? or *WAI. In continuous sweep mode, synchronization to the end of the measurement is not possible. Thus, it is not recommended that you use continuous sweep mode in remote control, as results like trace data or markers are only valid after a single sweep end synchronization.

Suffix:

<n> irrelevant

Example:

```
INIT:CONT OFF
```

Switches to single sweep mode.

```
DISP:WIND:TRAC:MODE AVER
```

Switches on trace averaging.

```
SWE:COUN 20
```

Setting the sweep counter to 20 sweeps.

```
INIT;*WAI
```

Starts the measurement and waits for the end of the 20 sweeps.

Mode:

all

SYSTem:DISPlay:UPDate <State>

In remote control mode, this command switches on or off the instrument display. If switched on, only the diagrams, traces and display fields are displayed and updated.

The best performance is obtained if the display output is switched off during remote control.

Parameters:

<State> ON | OFF

```
*RST: OFF
```

Example:

```
SYST:DISP:UPD ON
```

3 FM Stereo Option R&S FSV–K7S

The firmware option "FM Stereo" extends the "Analog Demodulation" option K7 to handle FM stereo signals. The "FM Stereo" mode requires an instrument equipped with the corresponding optional software, as well as the Analog Demodulation option (K7).

This section contains all information required for operation of an R&S FSV/FSV equipped with Application Firmware R&S FSV–K7S. It covers operation via menus and the remote control commands for FM stereo analog demodulation measurements.

- [Chapter 3.1, "Instrument Functions FM Stereo \(R&S FSV–K7S\)"](#), on page 188 shows all softkeys available in the "FM Stereo" menu. This chapter also presents the remote control commands associated with each softkey function.
- The following chapters describe the softkeys of the other keys for the FM Stereo option.
- [Chapter 3.2, "Remote Commands of the FM Stereo Option \(R&S FSV–K7S\)"](#), on page 227 describes all remote control commands defined for the FM Stereo option.

This part of the documentation includes only additional functions of the Application Firmware R&S FSV–K7S. For all other descriptions, please refer to the description of the Analog Demodulation option K7 (see [Chapter 2.2.1, "Softkeys of the Analog Demodulation Menu"](#), on page 26).

3.1 Instrument Functions FM Stereo (R&S FSV–K7S)

The firmware option R&S FSV–K7S (together with the Analog Demodulation option K7) provides the necessary measurement functions to demodulate FM stereo signals. It allows you to detect and analyze characteristic data in an FM stereo signal.

To open the FM Stereo menu

- If the "FM Stereo" mode is not the active measurement mode, press the [MODE] key and select the "FM Stereo" softkey.
- If the "FM Stereo" mode is already active, press the [HOME] key or the [MEAS] key.
The "FM Stereo" menu is displayed.

Menu and softkey description

The following softkey menus are specific to the FM Stereo option:

- [Chapter 3.1.2, "Softkeys of the FM Stereo Menu - MEAS key \(K7S\)"](#), on page 192
- [Chapter 3.1.3, "Softkeys of the Amplitude Menu – AMPT Key \(R&S FSV–K7S\)"](#), on page 206
- [Chapter 3.1.6, "Softkeys of the Marker Function Menu – MKR FUNC Key \(R&S FSV–K7S\)"](#), on page 220

- [Chapter 3.1.5, "Softkeys of the Trigger Menu – TRIG Key \(R&S FSV-K7S\)",](#) on page 215

Apart from the power measurement menu ([MEAS] key) that is not available in the "FM Stereo" mode, all other menus not described here are provided as described for Analog Demodulation mode (R&S FSV-K7). For details refer to the corresponding menu descriptions.

- [Chapter 2.2.2, "Softkeys of the Frequency Menu – FREQ Key \(Analog Demodulation\)",](#) on page 40
- [Chapter 2.2.3, "Softkeys of the Span Menu – SPAN Key \(Analog Demodulation\)",](#) on page 42
- [Chapter 2.2.5, "Softkeys of the Auto Set menu - AUTO SET Key \(Analog Demodulation\)",](#) on page 49
- [Chapter 2.2.7, "Softkeys of the Sweep Menu – SWEEP Key \(Analog Demodulation\)",](#) on page 55
- [Chapter 2.2.8, "Softkeys of the Trace Menu – TRACE key \(Analog Demodulation\)",](#) on page 57
- [Chapter 2.2.10, "Softkeys of the Marker Menu – MKR key \(Analog Demodulation\)",](#) on page 67

To display help to a softkey, press the HELP key and then the softkey for which you want to display help. To close the help window, press the ESC key. For further information refer to [Chapter 1.3, "How to Use the Help System",](#) on page 7.

Further Information

- [Chapter 2.1.3, "Sample Rate, Measurement Time and Trigger Offset",](#) on page 13
- [Chapter 3.1.1, "Measurement Result Display \(FM Stereo\)",](#) on page 189

3.1.1	Measurement Result Display (FM Stereo).....	189
3.1.2	Softkeys of the FM Stereo Menu - MEAS key (K7S).....	192
3.1.3	Softkeys of the Amplitude Menu – AMPT Key (R&S FSV-K7S).....	206
3.1.4	Softkeys of the Bandwidth Menu – BW Key (R&S FSV-K7S).....	211
3.1.5	Softkeys of the Trigger Menu – TRIG Key (R&S FSV-K7S).....	215
3.1.6	Softkeys of the Marker Function Menu – MKR FUNC Key (R&S FSV-K7S).....	220

3.1.1 Measurement Result Display (FM Stereo)

In FM Stereo mode, the measurement results can be displayed in up to 4 different screens (windows), plus an additional marker table, if applicable. Each screen shows either the measurement results as a diagram or the results of evaluation functions in a table ("Result Summary").

All displays are determined by the I/Q data set recorded for the measurement.

You can define the display configuration for up to 4 different screens at once using the ["Display Config"](#) on page 193 softkey.

Screen configuration

For each screen you can define:

- **Off:** Whether it is displayed or not
- **Summary:** Whether a result summary for all screens is displayed instead of a diagram
- **RF Diagrams:** Whether an RF diagram is displayed; these displays correspond to those for Analog Demodulation mode (R&S FSV-K7, see [Chapter 2.1.10, "Measurement Result Display"](#), on page 20)
- **FM Stereo Diagrams:** For which channel a time domain or spectrum diagram is displayed

Diagram types

The following diagram types can be selected for display.

- **RF Time Domain**
Selects the display of the RF power in zero span. In contrast to normal analyzer operation, the level values are the magnitude of the I/Q data set.

SCPI command:

`CALC:FEED 'XTIM:RFP'` (see [CALCulate<n>:FEED](#) on page 90)

- **RF Spectrum**
Selects the display of the RF signal in span > 0. In contrast to normal spectrum analyzer operation, the measured values are determined using FFT from the recorded I/Q data set.

SCPI command:

`CALC:FEED 'XTIM:SPECTRUM'` (see [CALCulate<n>:FEED](#) on page 90)

- **<FM Stereo Channel Type> Time Domain**
Selects the display of the channel power in zero span. In contrast to normal analyzer operation, the level values are the magnitude of the I/Q data set.

SCPI command:

`CALC:FEED 'XTIM:SFM:<ChannelType>'`, e.g. `CALC:FEED 'XTIM:SFM:LEFT'` (see [CALCulate<n>:FEED](#) on page 90)

- **<FM Stereo Channel Type> Spectrum**
Selects the display of the channel signal in span > 0. In contrast to normal spectrum analyzer operation, the measured values are determined using FFT from the recorded I/Q data set.

SCPI command:

`CALC:FEED 'XFR:SFM:<ChannelType>'`, e.g. `CALC:FEED 'XFR:SFM:LEFT'` (see [CALCulate<n>:FEED](#) on page 90)

Diagram header information

For each diagram, the header provides the following information:



1. Screen A/B/C/D
2. Channel type
3. Trace color
4. Trace number
5. Detector
6. Trace mode
7. Reference value

Diagram footer information

In addition to the used frequency and span information, the diagram footer also indicates the used weighting filter, if any, in FM stereo mode.

Result Summary

The result summary displays the results of the evaluation functions for all channels in a table.

D Result Summary							
Carrier Power: -30.00 dBm		Carrier Freq: 15.0 GHz		Ref Deviation: 54.305 kHz			
Cross Talk: -2.87 dB							
	Detector	Result Mode	Dev.	Rel. to Ref.	Mod. Freq.	SINAD	THD
Left	±Peak/2	Clear Write	54.305 kHz	0.00 dB	1.0000 kHz	70.88 dB	-92.99 dB
Right	±Peak/2	Clear Write	39.010 kHz	-2.87 dB	3.0000 kHz	67.95 dB	-97.02 dB
MPX	±Peak/2	Clear Write	73.596 kHz	2.64 dB	3.0000 kHz	1.98 dB	-85.42 dB
Mono	±Peak/2	Clear Write	36.336 kHz	-3.49 dB	1.0000 kHz	4.68 dB	-4.68 dB
Stereo	±Peak/2	Clear Write	63.823 kHz	1.40 dB	3.0000 kHz		
RDS	±Peak/2	Clear Write	2.046 kHz	-28.48 dB			
Pilot	±Peak/2	Clear Write	7.508 kHz	-17.19 dB	19.000 kHz		



Summaries that take up the entire width of the screen are displayed as tables; if only half the screen width is available (2 windows next to each other), the summary is displayed as a list. Thus, the factory-set predefined screen configurations contain only 3 screens: 2 for diagrams and one full-width screen for the summary.

For each channel, the following information is provided:

Label	Description
Detector	Selected detector type
Result Mode	Selected result mode
Dev.	Deviation
Rel. to Ref.	Relative to reference
Mod. Freq.	Modulation frequency

Label	Description
SINAD	<p>Signal-to-noise and distortion</p> <p>Measures the ratio of the total power to the power of noise and harmonic distortions. The noise and harmonic power is calculated inside the AF spectrum span. The DC offset is removed before the calculation.</p> $SINAD[dB] = 20 \cdot \log \left[\frac{\text{total power}}{\text{noise + distortion power}} \right]$
THD	<p>Total harmonic distortion</p> <p>The ratio of the harmonics to the fundamental and harmonics. All harmonics inside the AF spectrum span are considered up to the tenth harmonic.</p> $THD[dB] = 20 \cdot \log \left[\frac{\sqrt{\sum_{i=2}^{\infty} U_i^2}}{\sqrt{\sum_{i=1}^{\infty} U_i^2}} \right]$

In addition, the following general information for the input signal is provided:

- Carrier Power
- Carrier Frequency
- Reference Deviation
- Cross Talk (difference between left and right signal in dB), see also [CALCulate<n>:MARKer:FUNction:SFM:<ChannelType>\[:RESult<m>\]?](#) on page 234

3.1.2 Softkeys of the FM Stereo Menu - MEAS key (K7S)

This section describes all softkeys available in the "FM Stereo" menu.

Left.....	193
L Display Config.....	193
L Screen A-D.....	194
L Predefined.....	194
L Add.....	195
L Apply.....	195
L Remove.....	195
L Restore.....	195
L Close.....	195
L Result Summary Setup.....	196
L Detector.....	197
L Mode.....	197
L Coupled.....	197
L Meas To Ref.....	197
L Meas Time.....	197
L AF Filter.....	198

L High Pass.....	198
L Low Pass.....	199
L Weighting.....	199
L None.....	199
L CCITT.....	199
L CCIR Unweighted.....	200
L CCIR Weighted.....	200
L A Weighted.....	200
L Deemphasis.....	200
L Coupled.....	201
L All AF Filter Off.....	201
L AF Range.....	201
L Dev per Division.....	201
L Reference Position.....	202
L Reference Value.....	202
L AF Coupling AC/DC.....	202
L Deviation Lin/Log.....	203
L Unit.....	203
L Phase Unit (Rad/Deg).....	203
L THD Unit (% / DB).....	203
L Abs. Dev Unit (kHz/dBm).....	203
L Rel. Dev Unit (dB / %).....	203
L Time Domain Zoom.....	203
L State On / Off.....	203
L Start.....	204
L Length Manual.....	204
L Length Auto.....	204
L Time per Division.....	204
L Squelch.....	204
L Squelch Level.....	204
Right.....	205
MPX.....	205
Mono.....	205
Stereo.....	205
RDS.....	205
Pilot.....	205
RF Power.....	205
Display Config.....	205

Left

Displays the left signal of the FM stereo input and the "Left" submenu.

Remote command:

`CALCulate<n>:FEED` on page 90

Display Config ← Left

You configure the display settings for the results in the "Display Configuration" dialog box. This dialog box contains the following tabs:

- "Screen A-D": a separate tab for each of the four available screens
- "Predefined": for predefined display configurations

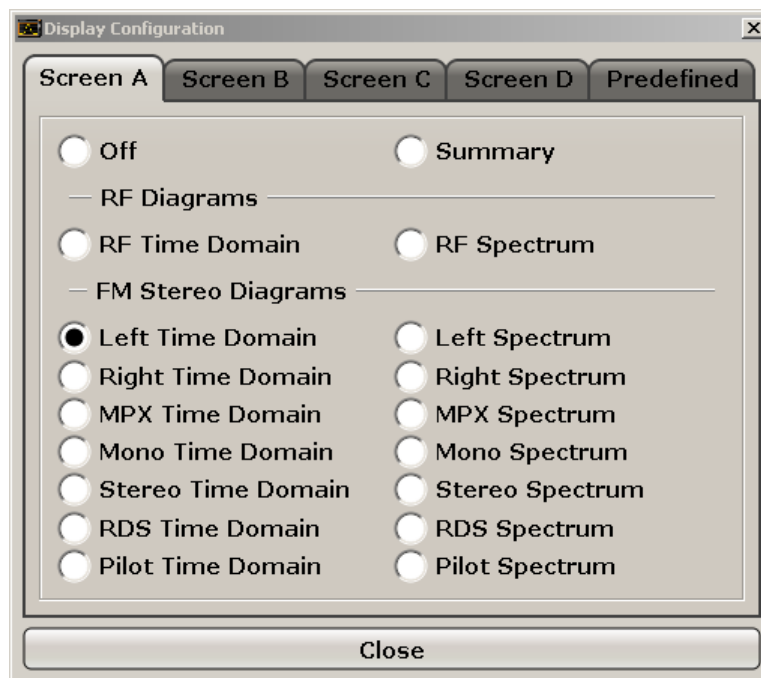

Screen A-D ← Display Config ← Left

For each of the four available screens you can configure what is to be displayed. To define the Display Configuration for a screen, select the corresponding tab. For each screen you can define:

- "Off": Whether it is displayed or not
- "Summary": Whether a summary of the evaluation lists from all screens is displayed instead of a diagram
- "RF Diagrams": Which type of diagram is displayed; this is the standard Analog Demodulation diagram type
For details on the result diagram types, see [Chapter 2.1.10, "Measurement Result Display"](#), on page 20.
- "FM Stereo Diagrams": Which type of FM stereo diagram is displayed; each measurement type can be displayed either in the time domain or as a spectrum

Note: Summaries that take up the entire width of the screen are displayed as tables; if only half the screen width is available (2 windows next to each other), the summary is displayed as a list. Thus, the factory-set predefined screen configurations contain only 3 screens: 2 for diagrams and one full-width screen for the summary.

Remote command:

[INSTrument\[:SElect\]](#) on page 116

Activates stereo fm demodulation.

[CALCulate<n>:FEED](#) on page 90

Defines the display configuration.

Predefined ← Display Config ← Left

You can store and load predefined screen configurations. All available configurations are displayed in the "Predefined" tab. The current screen configuration is indicated under "Current" at the top of the list.

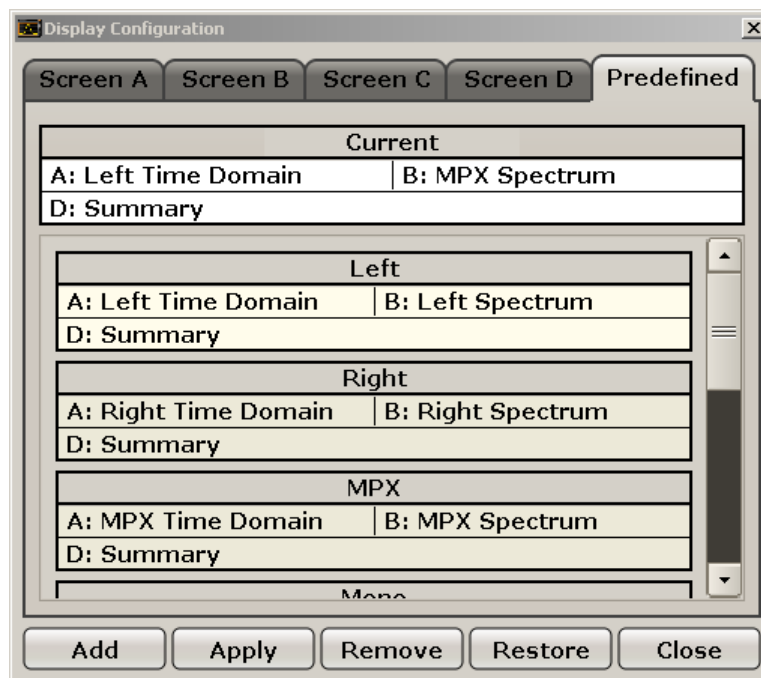
**Add ← Predefined ← Display Config ← Left**

Opens an edit dialog box to enter a name for the current screen configuration. The configuration is then stored and added to the list.

Apply ← Predefined ← Display Config ← Left

Applies the currently selected configuration from the list to the current display.

Remove ← Predefined ← Display Config ← Left

Removes the currently selected configuration from the list.

Restore ← Predefined ← Display Config ← Left

Restores the default display configuration. Existing configurations with the default names are replaced.

Close ← Predefined ← Display Config ← Left

Closes the displays settings dialog box.

Result Summary Setup ← Left

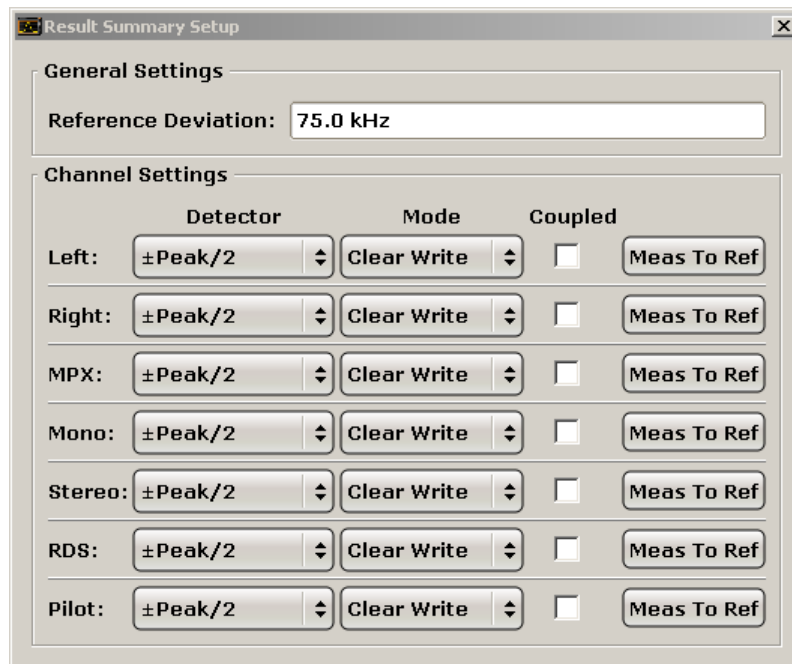

The result summary table displays the results of all channel measurements in a table. It is configured in the "Result Summary Setup" dialog box. This function is only available for screens for which an FM stereo measurement is selected in the "Display Settings" (see "Display Config" on page 193).

B Result Summary							
		Carrier Power: -200.97 dBm	Carrier Freq: 15.0 GHz	Mod Depth: 0.0 %			
	Detector	Result Mode	Dev.	Rel. to Ref.	Mod. Freq.	SINAD	THD
Left	±Peak/2	Clear Write	0.000 Hz	---	---	---	---
Right	±Peak/2	Clear Write	0.000 Hz	---	---	---	---
MPX	±Peak/2	Clear Write	0.000 Hz	---	---	---	---
Mono	±Peak/2	Clear Write	0.000 Hz	---	---	---	---
Stereo	±Peak/2	Clear Write	0.000 Hz	---	---	---	---
RDS	±Peak/2	Clear Write	0.000 Hz	---	---	---	---
Pilot	±Peak/2	Clear Write	0.000 Hz	---	---	---	---

Figure 3-1: Result summary for an FM stereo measurement

In the "General Settings" area you define the "Reference Deviation" for all summaries manually. Alternatively, you can determine the reference deviation from one of the channel measurements by selecting "Meas To Ref" (see "Meas To Ref" on page 197).

For each FM stereo channel you can define individual channel settings:

- "Detector" on page 197
- "Mode" on page 197
- "Coupled" on page 197
- "Meas To Ref" on page 197

Remote command:

[SENSe:] SFM:REfERENCE on page 235

[SENSe:] SFM:<ChannelType>:RSUMmary:DETECTOR[:FUNCTION] on page 242

[SENSe:] SFM:<ChannelType>:RSUMmary:MODE on page 243

[SENSe:] SFM:<ChannelType>:RSUMmary:COUPling on page 242
 [SENSe:] SFM:<ChannelType>:RSUMmary:REFerence[:AUTO] ONCE
 on page 244

Detector ← Result Summary Setup ← Left

Defines the detector used for the deviation measurement.

- "RMS"
- "RMS*SQRT2"
- "Pos Peak"
- "Neg Peak"
- "±Peak/2"
- "QP CCIR"
- "QP*SQRT2"

Note: To ensure correct measurements with QP detectors, it is recommended that you set the measurement time to its maximum value (see "Meas Time" on page 31 and Chapter 2.1.3, "Sample Rate, Measurement Time and Trigger Offset", on page 13).

Remote command:

[SENSe:] SFM:<ChannelType>:RSUMmary:DETector[:FUNctIon] on page 242

Mode ← Result Summary Setup ← Left

Defines the result summary mode for the absolute deviation and the deviation relative to the reference.

- | | |
|---------------|--|
| "Clear Write" | Overwrite mode: the summary is overwritten by each sweep. This is the default setting. |
| "Peak Hold" | The peak values are determined over several sweeps and displayed. |
| "Average" | The average is formed over several sweeps. |

Remote command:

[SENSe:] SFM:<ChannelType>:RSUMmary:MODE on page 243

Coupled ← Result Summary Setup ← Left

All channels for which this option is enabled are configured identically, i.e. the channel settings are coupled. If you change the settings for one coupled channel, the settings are changed for all other coupled channels, as well. The settings are taken from the first channel for which coupling is enabled.

Remote command:

[SENSe:] SFM:<ChannelType>:RSUMmary:COUPling on page 242

Meas To Ref ← Result Summary Setup ← Left

Determines the "Reference Deviation" from the current channel measurement.

Remote command:

[SENSe:] SFM:<ChannelType>:RSUMmary:REFerence[:AUTO] ONCE
 on page 244

Meas Time ← Left

Opens an editor for entering the measurement time of the analog demodulation. For details on the measurement time values refer to Chapter 2.1.3, "Sample Rate, Measurement Time and Trigger Offset", on page 13.

Note: For FM Stereo measurements (option K7S), the minimum measurement time is 2 ms.

Remote command:

[SENSe:] ADEMod:MTIME on page 133

AF Filter ← Left

Opens a dialog to select the appropriate filters.

The bandwidth of the demodulated signal can be reduced by high pass or low pass filters and also a weighting or de-emphasis can be switched on. You can define different filter settings for each channel.

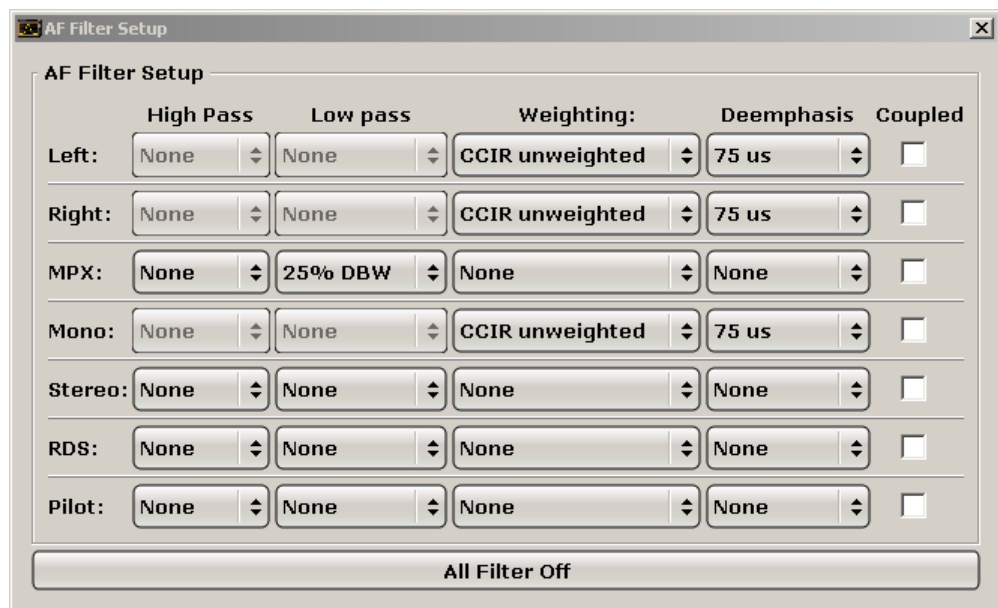

High Pass ← AF Filter ← Left

Opens the "High Pass" selection list to switch on a high pass filter with the given limit to separate the DC component. The filters are indicated by the 3 dB cutoff frequency. The 50 Hz and 300 Hz filters are designed as 2nd-order Butterworth filter (12 dB/octave). The 20 Hz filter is designed as 3rd-order Butterworth filter (18 dB/octave). "None" deactivates the AF high pass filter. Default is "None".

The high pass filters are active in the following demodulation bandwidth range:

20 Hz	100 Hz ≤ demodulation bandwidth ≤ 1.6 MHz
50 Hz:	200 Hz ≤ demodulation bandwidth ≤ 3 MHz
300 Hz:	800 Hz ≤ demodulation bandwidth ≤ 8 MHz
Note: for FM stereo (K7S), all filters are active at all times, as the demodulation range is always 400 kHz	

Remote command:

[SENSe:] FILTer<n>:HPASs [:STATe] on page 151

[SENSe:] FILTer<n>:HPASs:FREQuency on page 152

Low Pass ← AF Filter ← Left

Opens the "Low Pass" selection list to select the filter type. Relative and absolute low pass filter are available.

- Absolute low pass filters:
The 3 kHz, 15 kHz; 23 kHz and 150 kHz softkeys switch on a absolute low pass filter. The filters are indicated by the 3 dB cutoff frequency. The 3 kHz, 15 kHz and 23 kHz filters are designed as 5th-order Butterworth filters (30 dB/octave). The 150 kHz filter is designed as 8th-order Butterworth filter (48 dB/octave).
The absolute low pass filters are active in the following demodulation bandwidth range:

3 kHz:	6.4 kHz ≤ demodulation bandwidth ≤ 3 MHz
15 kHz:	50 kHz ≤ demodulation bandwidth ≤ 8 MHz
23 kHz	50 kHz ≤ demodulation bandwidth ≤ 18 MHz
150 kHz:	400 kHz ≤ demodulation bandwidth ≤ 8 MHz
Note: for FM stereo (K7S), all filters are active at all times, as the demodulation range is always 400 kHz	

- Relative low pass filters:
The filters (3 dB) can be selected in % of the demodulation bandwidth. The filters are designed as 5th-order Butterworth filter (30 dB/octave) and active for all demodulation bandwidths.
- "None" deactivates the AF low pass filter. Default is "None".

Remote command:

[\[SENSe:\] FILTer<n>:LPASs\[:STATe\]](#) on page 152

[\[SENSe:\] FILTer<n>:LPASs:FREQuency\[:ABSolute\]](#) on page 152

[\[SENSe:\] FILTer<n>:LPASs:FREQuency:RELative](#) on page 153

SFM:

[\[SENSe:\] SFM:<ChannelType>:FILTer:LPASs:STATe](#) on page 240

[\[SENSe:\] SFM:<ChannelType>:FILTer:LPASs:FREQuency](#) on page 241

Weighting ← AF Filter ← Left

Opens the "Weighting" selection list to select the weighting AF filter.

None ← Weighting ← AF Filter ← Left

Deactivates the weighting filter. This is the default setting.

Remote command:

[\[SENSe:\] FILTer<n>:HPASs\[:STATe\]](#) on page 151

CCITT ← Weighting ← AF Filter ← Left

Switches on a CCITT P.53 weighting filter. The weighting filter is active in the following demodulation bandwidth range:

20 kHz ≤ demodulation bandwidth ≤ 3 MHz

For FM stereo (K7S), the filter is active at all times, as the demodulation range is always 400 kHz.

Remote command:

[SENSe:] FILTer<n>:CCIT on page 149

SFM:

[SENSe:] SFM:<ChannelType>:FILTer:CCITt:STATe on page 237

CCIR Unweighted ← Weighting ← AF Filter ← Left

Switches on the CCIR unweighted filter, which is the combination of the 20 Hz high-pass and 23 kHz low pass filter. The weighting filter is active in the following demodulation bandwidth range:

50 kHz ≤ demodulation bandwidth ≤ 1.6 MHz

For FM stereo (K7S), the filter is active at all times, as the demodulation range is always 400 kHz.

Remote command:

[SENSe:] FILTer<n>:CCIR[:UNWeighted] [:STATe] on page 150

SFM:

[SENSe:] SFM:<ChannelType>:FILTer:CCIR[:UNWeighted] [:STATe]
on page 238

CCIR Weighted ← Weighting ← AF Filter ← Left

Switches on the CCIR weighted filter. The weighting filter is active in the following demodulation bandwidth range:

100 kHz ≤ demodulation bandwidth ≤ 3.0 MHz

For FM stereo (K7S), the filter is active at all times, as the demodulation range is always 400 kHz.

Remote command:

[SENSe:] FILTer<n>:CCIR:WEIGhted[:STATe] on page 150

SFM:

[SENSe:] SFM:<ChannelType>:FILTer:CCIR:WEIGhted[:STATe] on page 238

A Weighted ← Weighting ← AF Filter ← Left

Switches on the A weighted filter. The weighting filter is active in the following demodulation bandwidth range:

100 kHz ≤ demodulation bandwidth ≤ 800 kHz

Remote command:

[SENSe:] FILTer<n>:AWEighted[:STATe] on page 149

SFM:

[SENSe:] SFM:<ChannelType>:FILTer:AWEighted[:STATe] on page 237

Deemphasis ← AF Filter ← Left

Opens the "Deemphasis" selection list to switch on a deemphasis with the given time constant.

The deemphasis is active in the following demodulation bandwidth range:

Note: For FM stereo measurements (K7S), the demodulation bandwidth is always 400 kHz, thus the deemphasis is always active.

25 µs:	25 kHz ≤ demodulation bandwidth ≤ 40 MHz
50 µs:	6.4 kHz ≤ demodulation bandwidth ≤ 18 MHz
75 µs:	6.4 kHz ≤ demodulation bandwidth ≤ 18 MHz
750 µs:	800 Hz ≤ demodulation bandwidth ≤ 3 MHz

The following table shows the required demodulation bandwidth for an error less than 0.5 dB up to a maximum AF frequency.

deemphasis	25 µs	50 µs	75 µs	750 µs
max. AF frequency	25 kHz	12 kHz	8 kHz	800 Hz
required demodulation bandwidth	≥ 200 kHz	≥ 100 kHz	≥ 50 kHz	≥ 6.4 kHz

For higher AF frequencies the demodulation bandwidth must be increased.

Remote command:

[\[SENSe:\] FILTer<n>:DEMPHasis\[:STATe\]](#) on page 150

[\[SENSe:\] FILTer<n>:DEMPHasis:TCONstant](#) on page 151

SFM:

[\[SENSe:\] SFM:<ChannelType>:FILTer:DEMPHasis:STATe](#) on page 239

[\[SENSe:\] SFM:<ChannelType>:FILTer:DEMPHasis:TCONstant](#) on page 239

Coupled ← AF Filter ← Left

All channels for which this option is enabled are configured identically, i.e. the channel settings are coupled. If you change the settings for one coupled channel, the settings are changed for all other coupled channels, as well. The settings are taken from the first channel for which coupling is enabled.

Remote command:

[\[SENSe:\] SFM:<ChannelType>:RSUMmary:COUPling](#) on page 242

All AF Filter Off ← AF Filter ← Left

Disables all specified AF Filters.

Remote command:

[\[SENSe:\] FILTer<n>:AOFF](#) on page 148

AF Range ← Left

Opens a submenu to define the diagram scaling for AF displays.

Dev per Division ← AF Range ← Left

Opens an edit dialog box to set the modulation depth or the phase deviation (Analog Demodulation only), or frequency deviation per division:

AM display:	0.0001 % to 1000 %
FM display:	1 Hz/div to 100 MHz/div
PM display:	0.0001 rad/div to 1000 rad/div

The softkey is not available if logarithmic display is set ("Deviation Lin/Log" softkey).

Remote command:

`DISPlay[:WINDow<n>]:TRACe<t>:Y[:SCALe]:PDIVision` on page 112

Reference Position ← AF Range ← Left

Determines the position of the reference line for the modulation depth or the phase deviation (Analog Demodulation only) or frequency deviation on the y-axis of the diagram. By default, this line is set to 0.

The position is entered as a percentage of the diagram height with 100 % corresponding to the upper diagram border. The default setting is 50 % (diagram center) for the display of the AM, FM, or PM signal, and 100 % (upper diagram border) for the AF spectrum display of the AM, FM, or PM signal.

Remote command:

`DISPlay[:WINDow<n>]:TRACe<t>:Y[:SCALe]:RPOSition` on page 113

Reference Value ← AF Range ← Left

Determines the modulation depth or the phase deviation (Analog Demodulation only) or the frequency deviation at the reference line of the y-axis. The reference value is set separately for each display of the AM, FM, and PM signal and the AF spectrum of the AM, FM, and PM signal.

- AM/FM/PM signal display
The trace display takes individual frequency/phase offsets into account (in contrast, the **AF Coupling AC/DC** softkey permits automatic correction by the average frequency/phase offset of the signal, and can therefore not be activated simultaneously).
Possible values: 0 and ± 10000 % (AM), 0 and ± 10 MHz (FM), 0 and ± 10000 rad (PM).
- AF spectrum display of the AM/FM/PM signal
In the default setting, the reference value defines the modulation depth or the FM/PM deviation at the upper diagram border.
Possible values: 0 and 10000 % (AM), 0 and 10 MHz (FM), 0 and 10000 rad (PM).

Remote command:

`DISPlay[:WINDow<n>]:TRACe<t>:Y[:SCALe]:RVALue` on page 114

AF Coupling AC/DC ← AF Range ← Left

Controls the automatic correction of the frequency offset and phase offset of the input signal:

(**Note:** This function is not available with the AF spectrum display of the FM or PM signal.)

- FM signal display
If DC is selected, the absolute frequency is displayed, i.e. an input signal with an offset relative to the center frequency is not displayed symmetrically with respect to the zero line.
If AC is selected, the frequency offset is automatically corrected, i.e. the trace is always symmetric with respect to the zero line.
- PM signal display
If DC is selected, the phase runs according to the existing frequency offset. In addition, the DC signal contains a phase offset of $\pm \pi$.

If AC is selected, the frequency offset and phase offset are automatically corrected, i.e. the trace is always symmetric with respect to the zero line.

Remote command:

[\[SENSe:\]ADEMod<n>:AF:COUPLing](#) on page 122

Deviation Lin/Log ← AF Range ← Left

Switches between logarithmic and linear display of the modulation depth or the phase deviation (Analog Demodulation only) or the frequency deviation.

Remote command:

[DISPlay\[:WINDow<n>\]:TRACe<t>:Y:SPACing](#) on page 114

Unit ← AF Range ← Left

Opens a submenu to define the modulation unit.

Phase Unit (Rad/Deg) ← Unit ← AF Range ← Left

Sets the phase unit to rad or deg for displaying PM signals.

Remote command:

[UNIT:THD](#) on page 170

THD Unit (% / DB) ← Unit ← AF Range ← Left

Sets the unit to percent or DB for THD measurements.

Remote command:

[UNIT:THD](#) on page 170

Abs. Dev Unit (kHz/dBm) ← Unit ← AF Range ← Left

Sets the unit for absolute deviation to kHz or dBm. This softkey is only available with the FM Stereo option K7S.

Remote command:

[UNIT:ADEV](#) on page 249

Rel. Dev Unit (dB / %) ← Unit ← AF Range ← Left

Sets the unit for relative deviation to dB or percent. This softkey is only available with the FM Stereo option K7S.

Remote command:

[UNIT:RDEV](#) on page 250

Time Domain Zoom ← Left

Opens a submenu to activate and configure the zoom function.

State On / Off ← Time Domain Zoom ← Left

Activates or deactivates the time domain zoom according to the defined settings.

"ON" Activates the time domain zoom. The zoom area is defined using the "Start"["Start"](#) on page 36 and "Length Manual"["Length Manual"](#) on page 36 / "Length Auto"["Length Auto"](#) on page 36 softkeys.

"OFF" If more measured values than measurement points are available, several measured values are combined in one measurement point according to the method of the selected trace detector. For details on detectors refer to [Chapter 2.1.8, "Detector Overview"](#), on page 19.

Remote command:

[\[SENSe:\]ADEMod<n>:ZOOM\[:STATe\]](#) on page 143

Start ← Time Domain Zoom ← Left

Opens an edit dialog box to define the start time for the zoom area.

Remote command:

[\[SENSe:\]ADEMod<n>:ZOOM:START](#) on page 144

Length Manual ← Time Domain Zoom ← Left

Opens an edit dialog box to define the length of the zoom area (as a time value) manually.

Remote command:

[\[SENSe:\]ADEMod<n>:ZOOM:LENGTH](#) on page 144

Length Auto ← Time Domain Zoom ← Left

Automatically sets the length of the zoom area to the number of sweep points (see ["Sweep Points"](#) on page 57).

Remote command:

[\[SENSe:\]ADEMod<n>:ZOOM:LENGTH:MODE](#) on page 145

Time per Division ← Left

This function enables the "Time Domain Zoom" function and defines the zoom area length in one step. The width of the zoom display is divided into 10 divisions; thus, by entering the time that is displayed in each division, you indirectly define the zoom area length ("Time per Division" * 10). The starting point of the zoom area is determined automatically. To specify the starting point manually, use the "Start" function in the "Time Domain Zoom" submenu.

For details see "Time Domain Zoom".

Squelch ← Left

Activates the squelch function, i.e. if the signal falls below a defined threshold, the demodulated data is automatically set to 0. This is useful, for example, to avoid demodulation noise during transmission breaks.

Remote command:

[\[SENSe:\]ADEMod:SQUelch\[:STATe\]](#) on page 142

Squelch Level ← Left

Defines the level threshold below which the demodulated data is set to 0 if squelching is enabled. The squelch level is an absolute value.

Remote command:

[\[SENSe:\]ADEMod:SQUelch:LEVel](#) on page 142

Right

Displays the right signal of the FM stereo input and the "Right" submenu, which is identical to the "Left" submenu, see "Left" on page 193.

Remote command:

`CALCulate<n>:FEED` on page 90

MPX

Displays the MPX signal of the FM stereo input and the "MPX" submenu, which is identical to the "Left" submenu, see "Left" on page 193.

Remote command:

`CALCulate<n>:FEED` on page 90

Mono

Displays the mono signal of the FM stereo input (= Left channel + Right channel) and the "Mono" submenu, which is identical to the "Left" submenu, see "Left" on page 193.

Remote command:

`CALCulate<n>:FEED` on page 90

Stereo

Displays the stereo signal of the FM stereo input (= Left channel - Right channel) and the "Stereo" submenu, which is identical to the "Left" submenu, see "Left" on page 193.

Remote command:

`CALCulate<n>:FEED` on page 90

RDS

Displays the RDS signal of the FM stereo input and the "RDS" submenu, which is identical to the "Left" submenu, see "Left" on page 193.

Remote command:

`CALCulate<n>:FEED` on page 90

Pilot

Displays the pilot signal of the FM stereo input and the "Pilot" submenu, which is identical to the "Left" submenu, see "Left" on page 193.

Remote command:

`CALCulate<n>:FEED` on page 90

RF Power

Selects RF power as the modulation type, changes the signal display, and opens a submenu to set the measurement configuration. For details see the Analog Demodulation option K7 ("RF Power" on page 39).

Remote command:

`CALCulate<n>:FEED` on page 90

Display Config

See "Display Config" on page 193

3.1.3 Softkeys of the Amplitude Menu – AMPT Key (R&S FSV-K7S)

The following table shows all softkeys available in the "Amplitude" menu in "FM stereo" mode ([AMPT] key).

Ref Level.....	206
AF Range.....	206
L Dev per Division.....	206
L Reference Position.....	207
L Reference Value.....	207
L AF Coupling AC/DC.....	207
L Deviation Lin/Log.....	208
L Unit.....	208
L Phase Unit (Rad/Deg).....	208
L THD Unit (% / DB).....	208
L Abs. Dev Unit (kHz/dBm).....	208
L Rel. Dev Unit (dB / %).....	208
Unit.....	208
L Phase Unit (Rad/Deg).....	209
L THD Unit (% / DB).....	209
L Abs. Dev Unit (kHz/dBm).....	209
L Rel. Dev Unit (dB / %).....	209
Preamp On/Off.....	209
RF Atten Manual/Mech Att Manual.....	209
RF Atten Auto/Mech Att Auto.....	210
EI Atten On/Off.....	210
EI Atten Mode (Auto/Man).....	210
Ref Level Offset.....	211
Input (AC/DC).....	211
Input 50 Ω/75 Ω.....	211

Ref Level

Opens an edit dialog box to enter the reference level in the current unit (dBm, dBμV, etc).

The reference level is the maximum value the AD converter can handle without distortion of the measured value. Signal levels above this value will not be measured correctly, which is indicated by the "IFOVL" status display.

Remote command:

`DISPlay[:WINDow<n>]:TRACe<t>:Y[:SCALe]:RLEVEL` on page 113

AF Range

Opens a submenu to define the diagram scaling for AF displays.

Dev per Division ← AF Range

Opens an edit dialog box to set the modulation depth or the phase deviation (Analog Demodulation only), or frequency deviation per division:

AM display:	0.0001 % to 1000 %
FM display:	1 Hz/div to 100 MHz/div
PM display:	0.0001 rad/div to 1000 rad/div

The softkey is not available if logarithmic display is set ("Deviation Lin/Log" softkey).

Remote command:

`DISPlay[:WINDow<n>]:TRACe<t>:Y[:SCALe]:PDIVision` on page 112

Reference Position ← AF Range

Determines the position of the reference line for the modulation depth or the phase deviation (Analog Demodulation only) or frequency deviation on the y-axis of the diagram. By default, this line is set to 0.

The position is entered as a percentage of the diagram height with 100 % corresponding to the upper diagram border. The default setting is 50 % (diagram center) for the display of the AM, FM, or PM signal, and 100 % (upper diagram border) for the AF spectrum display of the AM, FM, or PM signal.

Remote command:

`DISPlay[:WINDow<n>]:TRACe<t>:Y[:SCALe]:RPOSition` on page 113

Reference Value ← AF Range

Determines the modulation depth or the phase deviation (Analog Demodulation only) or the frequency deviation at the reference line of the y-axis. The reference value is set separately for each display of the AM, FM, and PM signal and the AF spectrum of the AM, FM, and PM signal.

- AM/FM/PM signal display
The trace display takes individual frequency/phase offsets into account (in contrast, the **AF Coupling AC/DC** softkey permits automatic correction by the average frequency/phase offset of the signal, and can therefore not be activated simultaneously).
Possible values: 0 and ± 10000 % (AM), 0 and ± 10 MHz (FM), 0 and ± 10000 rad (PM).
- AF spectrum display of the AM/FM/PM signal
In the default setting, the reference value defines the modulation depth or the FM/PM deviation at the upper diagram border.
Possible values: 0 and 10000 % (AM), 0 and 10 MHz (FM), 0 and 10000 rad (PM).

Remote command:

`DISPlay[:WINDow<n>]:TRACe<t>:Y[:SCALe]:RVALue` on page 114

AF Coupling AC/DC ← AF Range

Controls the automatic correction of the frequency offset and phase offset of the input signal:

(**Note:** This function is not available with the AF spectrum display of the FM or PM signal.)

- FM signal display

If DC is selected, the absolute frequency is displayed, i.e. an input signal with an offset relative to the center frequency is not displayed symmetrically with respect to the zero line.

If AC is selected, the frequency offset is automatically corrected, i.e. the trace is always symmetric with respect to the zero line.

- PM signal display

If DC is selected, the phase runs according to the existing frequency offset. In addition, the DC signal contains a phase offset of $\pm \pi$.

If AC is selected, the frequency offset and phase offset are automatically corrected, i.e. the trace is always symmetric with respect to the zero line.

Remote command:

[\[SENSe:\]ADEMod<n>:AF:COUPling](#) on page 122

Deviation Lin/Log ← AF Range

Switches between logarithmic and linear display of the modulation depth or the phase deviation (Analog Demodulation only) or the frequency deviation.

Remote command:

[DISPlay\[:WINDow<n>\]:TRACe<t>:Y:SPACing](#) on page 114

Unit ← AF Range

Opens a submenu to define the modulation unit.

Phase Unit (Rad/Deg) ← Unit ← AF Range

Sets the phase unit to rad or deg for displaying PM signals.

Remote command:

[UNIT:THD](#) on page 170

THD Unit (% / DB) ← Unit ← AF Range

Sets the unit to percent or DB for THD measurements.

Remote command:

[UNIT:THD](#) on page 170

Abs. Dev Unit (kHz/dBm) ← Unit ← AF Range

Sets the unit for absolute deviation to kHz or dBm. This softkey is only available with the FM Stereo option K7S.

Remote command:

[UNIT:ADEV](#) on page 249

Rel. Dev Unit (dB / %) ← Unit ← AF Range

Sets the unit for relative deviation to dB or percent. This softkey is only available with the FM Stereo option K7S.

Remote command:

[UNIT:RDEV](#) on page 250

Unit

Opens a submenu to define the modulation unit.

Phase Unit (Rad/Deg) ← Unit

Sets the phase unit to rad or deg for displaying PM signals.

Remote command:

`UNIT:THD` on page 170

THD Unit (% / DB) ← Unit

Sets the unit to percent or DB for THD measurements.

Remote command:

`UNIT:THD` on page 170

Abs. Dev Unit (kHz/dBm) ← Unit

Sets the unit for absolute deviation to kHz or dBm. This softkey is only available with the FM Stereo option K7S.

Remote command:

`UNIT:ADEV` on page 249

Rel. Dev Unit (dB / %) ← Unit

Sets the unit for relative deviation to dB or percent. This softkey is only available with the FM Stereo option K7S.

Remote command:

`UNIT:RDEV` on page 250

Preamp On/Off

Switches the preamplifier on and off.

If option R&S FSV-B22 is installed, the preamplifier is only active below 7 GHz.

If option R&S FSV-B24 is installed, the preamplifier is active for all frequencies.

This function is not available for input from the R&S Digital I/Q Interface (option R&S FSV-B17).

Remote command:

`INPut:GAIN:STATe` on page 181

RF Atten Manual/Mech Att Manual

Opens an edit dialog box to enter the attenuation, irrespective of the reference level. If electronic attenuation is activated (option R&S FSV-B25 only; "EI Atten Mode Auto" softkey), this setting defines the mechanical attenuation.

The mechanical attenuation can be set in 10 dB steps.

The RF attenuation can be set in 5 dB steps (R&S FSV with option R&S FSV-B25 or R&S FSVA: 1 dB steps). The range is specified in the data sheet. If the current reference level cannot be set for the set RF attenuation, the reference level is adjusted accordingly.

This function is not available for input from the R&S Digital I/Q Interface (option R&S FSV-B17).

The RF attenuation defines the level at the input mixer according to the formula:

$$\text{level}_{\text{mixer}} = \text{level}_{\text{input}} - \text{RF attenuation}$$

Note: As of firmware version 1.61, the maximum mixer level allowed is **0 dBm**. Mixer levels above this value may lead to incorrect measurement results, which are indicated by the "OVLD" status display. The increased mixer level allows for an improved signal, but also increases the risk of overloading the instrument!

Remote command:

[INPut:ATTenuation](#) on page 177

RF Atten Auto/Mech Att Auto

Sets the RF attenuation automatically as a function of the selected reference level. This ensures that the optimum RF attenuation is always used. It is the default setting.

This function is not available for input from the R&S Digital I/Q Interface (option R&S FSV-B17).

Remote command:

[INPut:ATTenuation:AUTO](#) on page 177

EI Atten On/Off

This softkey switches the electronic attenuator on or off. This softkey is only available with option R&S FSV-B25.

When the electronic attenuator is activated, the mechanical and electronic attenuation can be defined separately. Note however, that both parts must be defined in the same mode, i.e. either both manually, or both automatically.

This function is not available for input from the R&S Digital I/Q Interface (option R&S FSV-B17).

- To define the mechanical attenuation, use the [RF Atten Manual/Mech Att Manual](#) or [RF Atten Auto/Mech Att Auto](#) softkeys.
- To define the electronic attenuation, use the [EI Atten Mode \(Auto/Man\)](#) softkey.

Note: This function is not available for stop frequencies (or center frequencies in zero span) >7 GHz. In this case, the electronic and mechanical attenuation are summarized and the electronic attenuation can no longer be defined individually. As soon as the stop or center frequency is reduced below 7 GHz, this function is available again. When the electronic attenuator is switched off, the corresponding RF attenuation mode (auto/manual) is automatically activated.

Remote command:

[INPut:EATT:AUTO](#) on page 181

EI Atten Mode (Auto/Man)

This softkey defines whether the electronic attenuator value is to be set automatically or manually. If manual mode is selected, an edit dialog box is opened to enter the value. This softkey is only available with option R&S FSV-B25, and only if the electronic attenuator has been activated via the [EI Atten On/Off](#) softkey.

Note: This function is not available for stop frequencies (or center frequencies in zero span) >7 GHz. In this case, the electronic and mechanical attenuation are summarized and the electronic attenuation can no longer be defined individually. As soon as the stop or center frequency is reduced below 7 GHz, electronic attenuation is available again. If the electronic attenuation was defined manually, it must be re-defined.

The attenuation can be varied in 1 dB steps from 0 to 30 dB. Other entries are rounded to the next lower integer value.

To re-open the edit dialog box for manual value definition, select the "Man" mode again.

If the defined reference level cannot be set for the given RF attenuation, the reference level is adjusted accordingly and the warning "Limit reached" is output.

Remote command:

`INPut:EATT:AUTO` on page 181

`INPut:EATT` on page 181

Ref Level Offset

Opens an edit dialog box to enter the arithmetic level offset. This offset is added to the measured level irrespective of the selected unit. The scaling of the y-axis is changed accordingly. The setting range is ± 200 dB in 0.1 dB steps.

Remote command:

`DISPlay[:WINDow<n>]:TRACe<t>:Y[:SCALe]:RLEVel:OFFSet` on page 113

Input (AC/DC)

Toggles the RF input of the R&S FSVA/FSV between AC and DC coupling.

This function is not available for input from the R&S Digital I/Q Interface (option R&S FSV-B17).

Remote command:

`INPut:COUPling` on page 178

Input 50 Ω /75 Ω

Uses 50 Ω or 75 Ω as reference impedance for the measured levels. Default setting is 50 Ω .

The setting 75 Ω should be selected if the 50 Ω input impedance is transformed to a higher impedance using a 75 Ω adapter of the RAZ type (= 25 Ω in series to the input impedance of the instrument). The correction value in this case is 1.76 dB = $10 \log(75 \Omega/50 \Omega)$.

All levels specified in this Operating Manual refer to the default setting of the instrument (50 Ω).

This function is not available for input from the R&S Digital I/Q Interface (option R&S FSV-B17).

Remote command:

`INPut:IMPedance` on page 182

3.1.4 Softkeys of the Bandwidth Menu – BW Key (R&S FSV-K7S)

The following table shows all softkeys available in the "Bandwidth" menu in FM Stereo mode (BW key).

<code>Res BW (span > 0)</code>	212
<code>Meas Time</code>	212
<code>AF Filter</code>	212
L <code>High Pass</code>	212
L <code>Low Pass</code>	213

- L Weighting..... 213
 - L None..... 213
 - L CCITT..... 213
 - L CCIR Unweighted..... 214
 - L CCIR Weighted..... 214
 - L A Weighted..... 214
- L Deemphasis..... 214
- L All AF Filter Off..... 215

Res BW (span > 0)

Opens an edit dialog box to enter a value for the resolution bandwidth. The range is specified in the data sheet.

This softkey is only available for spectrum measurements (see Chapter 2.1.10, "Measurement Result Display", on page 20).

Remote command:

[SENSe:]ADEMod:SPECTrum:BANDwidth|BWIDth[:RESolution] on page 140

Meas Time

Opens an editor for entering the measurement time of the analog demodulation. For details on the measurement time values refer to Chapter 2.1.3, "Sample Rate, Measurement Time and Trigger Offset", on page 13.

Note: For FM Stereo measurements (option K7S), the minimum measurement time is 2 ms.

Remote command:

[SENSe:]ADEMod:MTIME on page 133

AF Filter

The bandwidth of the demodulated signal can be reduced by high pass or low pass filters and also a de-emphasis can be switched on. The selected filters are used for AM, FM and PM demodulation in common. Individual settings are not possible.

High Pass ← AF Filter

Opens the "High Pass" selection list to switch on a high pass filter with the given limit to separate the DC component. The filters are indicated by the 3 dB cutoff frequency. The 50 Hz and 300 Hz filters are designed as 2nd-order Butterworth filter (12 dB/octave). The 20 Hz filter is designed as 3rd-order Butterworth filter (18 dB/octave).

"None" deactivates the AF high pass filter. Default is "None".

The high pass filters are active in the following demodulation bandwidth range:

20 Hz	100 Hz ≤ demodulation bandwidth ≤ 1.6 MHz
50 Hz:	200 Hz ≤ demodulation bandwidth ≤ 3 MHz
300 Hz:	800 Hz ≤ demodulation bandwidth ≤ 8 MHz
Note: for FM stereo (K7S), all filters are active at all times, as the demodulation range is always 400 kHz	

Remote command:

[SENSe:] FILTer<n>:HPASs[:STATe] on page 151

[SENSe:] FILTer<n>:HPASs:FREQuency on page 152

Low Pass ← AF Filter

Opens the "Low Pass" selection list to select the filter type. Relative and absolute low pass filter are available.

- Absolute low pass filters:
The 3 kHz, 15 kHz; 23 kHz and 150 kHz softkeys switch on a absolute low pass filter. The filters are indicated by the 3 dB cutoff frequency. The 3 kHz, 15 kHz and 23 kHz filters are designed as 5th-order Butterworth filters (30 dB/octave). The 150 kHz filter is designed as 8th-order Butterworth filter (48 dB/octave).
The absolute low pass filters are active in the following demodulation bandwidth range:

3 kHz:	6.4 kHz ≤ demodulation bandwidth ≤ 3 MHz
15 kHz:	50 kHz ≤ demodulation bandwidth ≤ 8 MHz
23 kHz:	50 kHz ≤ demodulation bandwidth ≤ 18 MHz
150 kHz:	400 kHz ≤ demodulation bandwidth ≤ 8 MHz
Note: for FM stereo (K7S), all filters are active at all times, as the demodulation range is always 400 kHz	

- Relative low pass filters:
The filters (3 dB) can be selected in % of the demodulation bandwidth. The filters are designed as 5th-order Butterworth filter (30 dB/octave) and active for all demodulation bandwidths.
- "None" deactivates the AF low pass filter. Default is "None".

Remote command:

[SENSe:] FILTer<n>:LPASs[:STATe] on page 152

[SENSe:] FILTer<n>:LPASs:FREQuency[:ABSolute] on page 152

[SENSe:] FILTer<n>:LPASs:FREQuency:RELative on page 153

SFM:

[SENSe:] SFM:<ChannelType>:FILTer:LPASs:STATe on page 240

[SENSe:] SFM:<ChannelType>:FILTer:LPASs:FREQuency on page 241

Weighting ← AF Filter

Opens the "Weighting" selection list to select the weighting AF filter.

None ← Weighting ← AF Filter

Deactivates the weighting filter. This is the default setting.

Remote command:

[SENSe:] FILTer<n>:HPASs[:STATe] on page 151

CCITT ← Weighting ← AF Filter

Switches on a CCITT P.53 weighting filter. The weighting filter is active in the following demodulation bandwidth range:

20 kHz ≤ demodulation bandwidth ≤ 3 MHz

For FM stereo (K7S), the filter is active at all times, as the demodulation range is always 400 kHz.

Remote command:

[SENSe:] FILTer<n>:CCIT on page 149

SFM:

[SENSe:] SFM:<ChannelType>:FILTer:CCITt:STATe on page 237

CCIR Unweighted ← Weighting ← AF Filter

Switches on the CCIR unweighted filter, which is the combination of the 20 Hz high-pass and 23 kHz low pass filter. The weighting filter is active in the following demodulation bandwidth range:

50 kHz ≤ demodulation bandwidth ≤ 1.6 MHz

For FM stereo (K7S), the filter is active at all times, as the demodulation range is always 400 kHz.

Remote command:

[SENSe:] FILTer<n>:CCIR[:UNWeighted] [:STATe] on page 150

SFM:

[SENSe:] SFM:<ChannelType>:FILTer:CCIR[:UNWeighted] [:STATe] on page 238

CCIR Weighted ← Weighting ← AF Filter

Switches on the CCIR weighted filter. The weighting filter is active in the following demodulation bandwidth range:

100 kHz ≤ demodulation bandwidth ≤ 3.0 MHz

For FM stereo (K7S), the filter is active at all times, as the demodulation range is always 400 kHz.

Remote command:

[SENSe:] FILTer<n>:CCIR:WEIGhted[:STATe] on page 150

SFM:

[SENSe:] SFM:<ChannelType>:FILTer:CCIR:WEIGhted[:STATe] on page 238

A Weighted ← Weighting ← AF Filter

Switches on the A weighted filter. The weighting filter is active in the following demodulation bandwidth range:

100 kHz ≤ demodulation bandwidth ≤ 800 kHz

Remote command:

[SENSe:] FILTer<n>:AWEighteD[:STATe] on page 149

SFM:

[SENSe:] SFM:<ChannelType>:FILTer:AWEighteD[:STATe] on page 237

Deemphasis ← AF Filter

Opens the "Deemphasis" selection list to switch on a deemphasis with the given time constant.

The deemphasis is active in the following demodulation bandwidth range:

Note: For FM stereo measurements (K7S), the demodulation bandwidth is always 400 kHz, thus the deemphasis is always active.

25 µs:	25 kHz ≤ demodulation bandwidth ≤ 40 MHz
50 µs:	6.4 kHz ≤ demodulation bandwidth ≤ 18 MHz
75 µs:	6.4 kHz ≤ demodulation bandwidth ≤ 18 MHz
750 µs:	800 Hz ≤ demodulation bandwidth ≤ 3 MHz

The following table shows the required demodulation bandwidth for an error less than 0.5 dB up to a maximum AF frequency.

deemphasis	25 µs	50 µs	75 µs	750 µs
max. AF frequency	25 kHz	12 kHz	8 kHz	800 Hz
required demodulation bandwidth	≥ 200 kHz	≥ 100 kHz	≥ 50 kHz	≥ 6.4 kHz

For higher AF frequencies the demodulation bandwidth must be increased.

Remote command:

[\[SENSe:\] FILTer<n>:DEMPHasis\[:STATe\]](#) on page 150

[\[SENSe:\] FILTer<n>:DEMPHasis:TCONstant](#) on page 151

SFM:

[\[SENSe:\] SFM:<ChannelType>:FILTer:DEMPHasis:STATe](#) on page 239

[\[SENSe:\] SFM:<ChannelType>:FILTer:DEMPHasis:TCONstant](#) on page 239

All AF Filter Off ← AF Filter

Disables all specified AF Filters.

Remote command:

[\[SENSe:\] FILTer<n>:AOFF](#) on page 148

3.1.5 Softkeys of the Trigger Menu – TRIG Key (R&S FSV-K7S)

The following table shows all softkeys available in the "Trigger" menu in "FM Stereo" mode ([TRIG] key). It is possible that your instrument configuration does not provide all softkeys. If a softkey is only available with a special option, model or (measurement) mode, this information is delivered in the corresponding softkey description.

Trigger Source.....	216
L Free Run.....	216
L External.....	216
L RF Power.....	216
L IF Power.....	217
L Left.....	217
L Right.....	217
L MPX.....	217
L Mono.....	218
L Stereo.....	218
L RDS.....	218
L Pilot.....	218
L RF.....	218

L Time.....	218
Trigger Level.....	218
Trigger Polarity.....	218
Trigger Offset.....	219
Repetition Interval.....	219
Trigger Hysteresis.....	219
Trigger Holdoff.....	220

Trigger Source

Opens the "Trg Source" submenu to select the trigger source.

In "FM Stereo" mode, the next measurement is triggered if the selected input signal exceeds the threshold specified using the "Trigger Level" on page 66 softkey. A periodic signal modulated onto the carrier frequency can be displayed in this way. It is recommended that the measurement time covers at least five periods of the audio signal.

For triggering to be successful, the measurement time must cover at least 5 periods of the audio signal.

Remote command:

TRIGger<n> [:SEquence] :SOURce on page 167

Free Run ← Trigger Source

The start of a sweep is not triggered. Once a measurement is completed, another is started immediately.

Remote command:

TRIG:SOUR IMM, see TRIGger<n> [:SEquence] :SOURce on page 167

External ← Trigger Source

Defines triggering via a TTL signal at the "EXT TRIG/GATE IN" input connector on the rear panel.

Remote command:

TRIG:SOUR EXT, see TRIGger<n> [:SEquence] :SOURce on page 167

RF Power ← Trigger Source

Defines triggering of the measurement via signals which are outside the measurement channel.

This trigger mode is available with detector board 1307.9554.02 Rev 05.00 or higher. It is not available for input from the R&S Digital I/Q Interface (option R&S FSV-B17). If RF Power trigger mode is selected and digital baseband input is activated, the trigger mode is automatically switched to "Free Run".

RF power triggers are not available together with the bandwidth extension option R&S FSV-B160.

In RF Power trigger mode the instrument uses a level detector at the first intermediate frequency. The detector threshold can be selected in a range between - 50 dBm and -10 dBm at the input mixer. The resulting trigger level at the RF input lies within the following range:

$(-24\text{dBm} + \text{RF Att}) \leq \text{Triggerlevel} \leq (+5\text{dBm} + \text{RF Att}), \text{ max. } 30 \text{ dBm}, \text{ for Preamp} = \text{OFF}$

$(-40\text{dBm} + \text{RF Att}) \leq \text{Triggerlevel} \leq (-11\text{dBm} + \text{RF Att}), \text{ max. } 30 \text{ dBm}, \text{ for Preamp} = \text{ON}$

with

$500 \text{ MHz} \leq \text{InputSignal} \leq 7 \text{ GHz}$

Note: If input values outside of this range occur (e.g. for fullspan measurements), the sweep may be aborted and a message indicating the allowed input values is displayed in the status bar.

Remote command:

TRIG:SOUR RFP, see TRIGger<n>[:SEQuence]:SOURce on page 167

SWE:EGAT:SOUR RFP for gated triggering, see [SENSe:]SWEep:EGATe:SOURce on page 156

IF Power ← Trigger Source

Defines triggering of the measurement via signals which are outside the measurement channel.

For this purpose, the R&S FSVA/FSV uses a level detector at the second intermediate frequency.

The available trigger levels depend on the RF attenuation and preamplification. A reference level offset, if defined, is also considered.

For details on available trigger levels and trigger bandwidths see the data sheet.

The bandwidth at the intermediate frequency is 20 MHz. The R&S FSVA/FSV is triggered as soon as the trigger level is exceeded within a 10 MHz range around the selected frequency (= start frequency in the frequency sweep).

Thus, the measurement of spurious emissions, e.g. for pulsed carriers, is possible even if the carrier lies outside the selected frequency span.

IF power triggers are not available together with the bandwidth extension option R&S FSV-B160.

Remote command:

TRIG:SOUR IFP, see TRIGger<n>[:SEQuence]:SOURce on page 167

SWE:EGAT:SOUR IFP for gated triggering, see [SENSe:]SWEep:EGATe:SOURce on page 156

Left ← Trigger Source

Triggers on the specified frequency level of the left FM signal.

Remote command:

TRIGger<n>[:SEQuence]:LEVel:SFM:LEFT on page 245

Right ← Trigger Source

Triggers on the specified frequency level of the right FM signal.

Remote command:

TRIGger<n>[:SEQuence]:LEVel:SFM:RIGHT on page 245

MPX ← Trigger Source

Triggers on the specified frequency level of the MPX FM signal.

Remote command:

TRIGger<n>[:SEQuence]:LEVel:SFM:MPX on page 246

Mono ← Trigger Source

Triggers on the specified frequency level of the mono FM signal.

Remote command:

`TRIGger<n>[:SEquence]:LEVel:SFM:MONO` on page 246

Stereo ← Trigger Source

Triggers on the specified frequency level of the stereo FM signal.

Remote command:

`TRIGger<n>[:SEquence]:LEVel:SFM:STEReo` on page 247

RDS ← Trigger Source

Triggers on the specified frequency level of the RDS FM signal.

Remote command:

`TRIGger<n>[:SEquence]:LEVel:SFM:RDS` on page 247

Pilot ← Trigger Source

Triggers on the specified frequency level of the pilot FM signal.

Remote command:

`TRIGger<n>[:SEquence]:LEVel:SFM:PILot` on page 247

RF ← Trigger Source

Triggers on the specified level of the RF signal.

Note: The RF **offline** trigger is based on the I/Q data of the demodulated signal, in a very limited bandwidth. For a wider trigger bandwidth and triggering based on the currently measured RF input signal, use the more powerful **RF Power** trigger.

Remote command:

`TRIGger<n>[:SEquence]:LEVel:AM[:ABSolute]` on page 164

Time ← Trigger Source

Opens an edit dialog box to define a repetition interval in which the measurement is triggered. The shortest interval is 2 ms.

Remote command:

`TRIG:SOUR TIME``TRIGger<n>[:SEquence]:SOURce` on page 167

Trigger Level

Defines the trigger level as a numeric value.

In the trigger mode "Time", this softkey is not available.

Remote command:

`TRIGger<n>[:SEquence]:LEVel:IFPower` on page 165

For digital input via the R&S Digital I/Q Interface, R&S FSV-B17:

`TRIGger<n>[:SEquence]:LEVel:BBPower` on page 165

Trigger Polarity

Sets the polarity of the trigger source.

The sweep starts after a positive or negative edge of the trigger signal. The default setting is "Pos". The setting applies to all modes with the exception of the "Free Run" and "Time" mode.

- "Pos" Level triggering: the sweep is stopped by the logic "0" signal and restarted by the logical "1" signal after the gate delay time has elapsed.
- "Neg" Edge triggering: the sweep is continued on a "0" to "1" transition for the gate length duration after the gate delay time has elapsed.

Remote command:

[TRIGger<n>\[:SEquence\]:SLOPe](#) on page 167

[\[SENSe:\]SWEep:EGATe:POLarity](#) on page 156

Trigger Offset

Opens an edit dialog box to enter the time offset between the trigger signal and the start of the sweep.

offset > 0:	Start of the sweep is delayed
offset < 0:	<p>Sweep starts earlier (pre-trigger)</p> <p>Only possible for span = 0 (e.g. I/Q Analyzer mode) and gated trigger switched off</p> <p>Maximum allowed range limited by the sweep time: $\text{pretrigger}_{\text{max}} = \text{sweep time}$</p> <p>When using the R&S Digital I/Q Interface (R&S FSV-B17) with I/Q Analyzer mode, the maximum range is limited by the number of pretrigger samples.</p> <p>See the R&S Digital I/Q Interface(R&S FSV-B17) description in the base unit.</p>

In the "External" or "IF Power" trigger mode, a common input signal is used for both trigger and gate. Therefore, changes to the gate delay will affect the trigger delay (trigger offset) as well.

In the "Time" trigger mode, this softkey is not available.

Remote command:

[TRIGger<n>\[:SEquence\]:HOLDoff\[:TIME\]](#) on page 163

Repetition Interval

Opens an edit dialog box to define a repetition interval in which the measurement is triggered. The shortest interval is 2 ms. This softkey is only available if the trigger source "Time" is selected (see "Time" on page 66).

Remote command:

[TRIGger<n>\[:SEquence\]:TIME:RINterval](#) on page 166

Trigger Hysteresis

Defines the value for the trigger hysteresis for "IF power" or "RF Power" trigger sources. The hysteresis in dB is the value the input signal must stay below the power trigger level in order to allow a trigger to start the measurement. The range of the value is between 3 dB and 50 dB with a step width of 1 dB.

Remote command:

[TRIGger<n>\[:SEquence\]:IFPower:HYSteresis](#) on page 164

Trigger Holdoff

Defines the value for the trigger holdoff. The holdoff value in s is the time which must pass before triggering, in case another trigger event happens.

This softkey is only available if "IFPower", "RF Power" or "BBPower" is the selected trigger source.

Remote command:

[TRIGger<n>\[:SEquence\]:IFPower:HOLDoff](#) on page 163

For digital input via the R&S Digital I/Q Interface, R&S FSV-B17:

[TRIGger<n>\[:SEquence\]:BBPower:HOLDoff](#) on page 163

3.1.6 Softkeys of the Marker Function Menu – MKR FUNC Key (R&S FSV-K7S)

The [MKR FUNC] menu provides the following functions.

Select Marker (No).....	220
Ref Fixed.....	221
L Ref. Fixed On/Off.....	221
L Ref Point Level.....	221
L Ref Point Frequency (span > 0)/Ref Point Time (zero span).....	221
L Peak Search.....	221
Diff.Freq.Distortion.....	221
L Diff.Freq.Distortion (On/Off).....	222
L Unit (% / DB).....	222
L Search Signals.....	223
Intermod. Distortion.....	223
L Intermod.Distortion (On/Off).....	224
L Unit (% / DB).....	224
L Search Signals.....	224
n dB down.....	224
Marker Peak List.....	225
L Peak List On/Off.....	225
L Sort Mode Freq/Lvl.....	225
L Max Peak Count.....	225
L Peak Excursion.....	225
L Left Limit.....	226
L Right Limit.....	226
L Threshold.....	226
L ASCII File Export.....	226
L Decim Sep.....	226
L Marker Number.....	226

Select Marker (No)

Opens a submenu to select one of 16 markers and define whether the marker is a normal or a delta marker (see "[Marker 1 / Marker 2 / Marker 3 / ... Marker 16, / Marker Norm/Delta](#)" on page 68). "(No)" indicates the number of the currently active marker.

See "[Marker 1 / Marker 2 / Marker 3 / ... Marker 16 / Marker Norm/Delta](#)" on page 68.

Ref Fixed

Opens a submenu to set all values of a reference point. Instead of using the current values of the reference marker (marker 1) as reference point for the delta markers, level and frequency or time are set to fixed values and used as reference point.

Ref. Fixed On/Off ← Ref Fixed

Switches the relative measurement to a fixed reference value on or off. The level and frequency or time values of marker 1 immediately become the reference point, but can be altered using the corresponding softkeys ("[Ref Point Level](#)" on page 72, "[Ref Point Frequency \(span > 0\)/Ref Point Time \(zero span\)](#)" on page 73 and "[Peak Search](#)" on page 73).

When set to ON, all delta markers which previously referenced marker 1 are automatically set to reference the fixed marker.

The reference marker assignment can be changed using the "Marker Wizard" (see "[Marker Wizard](#)" on page 68).

Remote command:

`CALCulate<n>:DELTamarker<m>:FUNction:FIXed[:STATe]` on page 172

Ref Point Level ← Ref Fixed

Opens an edit dialog box to enter a reference level value. All relative level values of the delta markers refer to this reference level.

Remote command:

`CALCulate<n>:DELTamarker<m>:FUNction:FIXed:RPoint:Y` on page 171

Ref Point Frequency (span > 0)/Ref Point Time (zero span) ← Ref Fixed

Opens an edit dialog box to enter a frequency reference or time value. All relative frequency or time values of the delta markers refer to this frequency reference. For phase noise measurement, input of reference time is not possible.

Remote command:

`CALCulate<n>:DELTamarker<m>:FUNction:FIXed:RPoint:X` on page 171

Peak Search ← Ref Fixed

Sets the maximum value of the selected trace as the reference point.

Remote command:

`CALCulate<n>:DELTamarker<m>:FUNction:FIXed:RPoint:MAXimum[:PEAK]` on page 170

Diff.Freq.Distortion

Opens a submenu to enable and configure difference frequency distortion measurement. This function is only available for AF spectrum measurements.

Definition of the difference frequency distortion:

f1 and f2 represent the frequencies of two sine-wave signals with the same level. Their frequencies should preferably differ by 80 Hz. The difference frequency distortion factors of 2nd and 3rd order (dd2, dd3) are defined as follows:

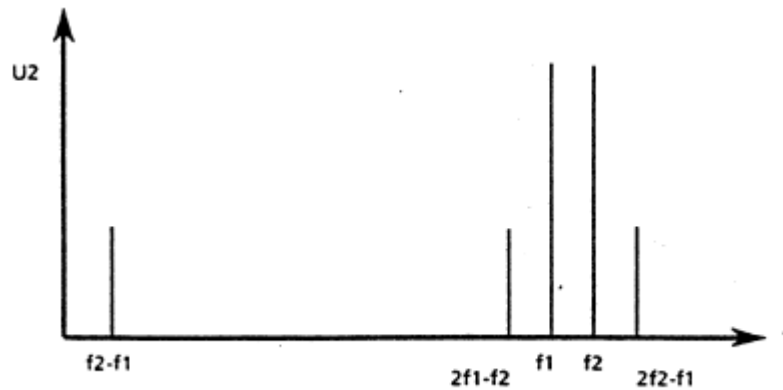

$$d_{d2} = \frac{U_2(f_2 - f_1)}{2 * U_2(f_2)} * 100\%$$

for percentage indication or

$$d_{d2} = 20 * \lg\left(\frac{U_2(f_2 - f_1)}{2 * U_2(f_2)} \right)$$

for indication in dB

$$d_{d3} = \frac{U_2(2 * f_2 - f_1) + U_2(2 * f_1 - f_2)}{2 * U_2(f_2)}$$

for percentage indication or

$$d_{d3} = 20 * \lg\left(\frac{U_2(2 * f_2 - f_1) + U_2(2 * f_1 - f_2)}{2 * U_2(f_2)} \right)$$

for indication in dB

Diff.Freq.Distortion (On/Off) ← Diff.Freq.Distortion

Enables difference frequency distortion. The results are displayed in the summary table with the function "DiffDist 2/3". The markers are indicated as "DFD2, DFD3".

Remote command:

`CALCulate<n>:MARKer:FUNction:DFD[:STATe]` on page 230

Unit (% / DB) ← Diff.Freq.Distortion

Sets the unit to percent or DB for differential frequency distortion.

Remote command:

`CALCulate<n>:MARKer:FUNction:DFD:UNIT` on page 230

Search Signals ← Diff.Freq.Distortion

Starts the search of the signals required for the difference frequency distortion measurement.

Remote command:

CALCulate<n>:MARKer:FUNCTion:DFD:SEARChsignal ONCE on page 231

Intermod. Distortion

Opens a submenu to enable and configure intermodulation distortion measurement. This function is only available for AF spectrum measurements.

Definition of the intermodulation distortion:

f_1 and f_2 represent the frequencies of two sine-wave signals. f_2 should be at least $8 \cdot f_1$. The level of f_2 should be 1/4th of the level of f_1 . The modulation factors of 2nd and 3rd order (dm_2 , dm_3) are defined as follows:

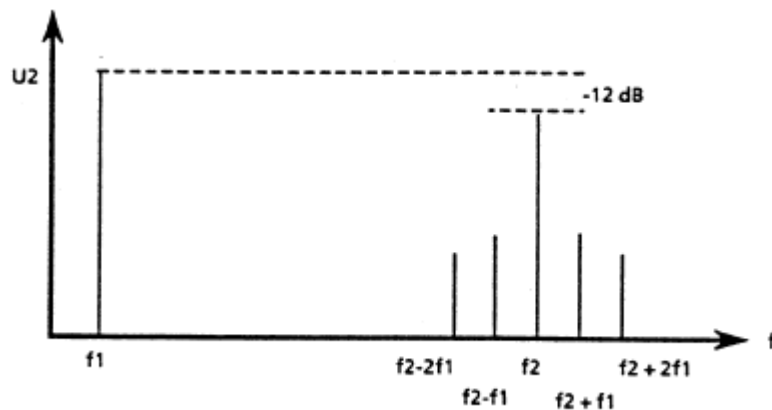

$$dm_2 = \frac{U_2(f_2 + f_1) + U_2(f_2 - f_1)}{U_2(f_2)} \cdot 100\%$$

for percentage indication or

$$dm_2 = 20 \cdot \lg\left(\frac{U_2(f_2 + f_1) + U_2(f_2 - f_1)}{U_2(f_2)} \right)$$

for indication in dB

$$dm_3 = \frac{U_2(f_2 + 2f_1) + U_2(f_2 - 2f_1)}{U_2(f_2)} \cdot 100\%$$

for percentage indication

$$dm_3 = 20 \cdot \lg\left(\frac{U_2(f_2 + 2f_1) + U_2(f_2 - 2f_1)}{U_2(f_2)} \right)$$

for indication in dB

Intermod.Distortion (On/Off) ← Intermod. Distortion

Enables intermodulation distortion. The results are displayed in the summary table with the function "IModDist 2/3". The markers are indicated as "IMD2, IMD3".

Remote command:

`CALCulate<n>:MARKer:FUNCtion:IMD[:STATe]` on page 232

Unit (% / DB) ← Intermod. Distortion

Sets the unit to percent or DB for intermodulation distortion.

Remote command:

`CALCulate<n>:MARKer:FUNCtion:IMD:UNIT` on page 232

Search Signals ← Intermod. Distortion

Starts the search of the signals required for the intermodulation distortion measurement.

Remote command:

`CALCulate<n>:MARKer:FUNCtion:IMD:SEARChsignal ONCE` on page 233

n dB down

Opens an edit dialog box to enter a value to define the level spacing of the two temporary markers to the right and left of marker 1 (default setting: 3 dB). Activates the temporary markers T1 and T2. The values of the temporary markers (T1, T2) and the entered value (ndB) are displayed in the marker field.

If a positive value is entered, the markers T1 and T2 are placed below the active reference marker. If a negative value (e.g. for notch filter measurements) is entered, the markers T1 and T2 are placed above the active reference marker. Marker T1 is placed to the left and marker T2 to the right of the reference marker.

In the marker table, the following results are displayed:

Span setting	Parameter name	Description
span > 0	Bw	frequency spacing of the two temporary markers
	Q factor	quality of the displayed bandwidth value (Bw)
span = 0	PWid	pulse width between the two temporary markers

If it is not possible to form the frequency spacing for the n dB value (e.g. because of noise display), dashes instead of a measured value are displayed.

Remote command:

`CALC:MARK1:FUNC:NDBD:STAT ON`, see `CALCulate<n>:MARKer<m>:FUNCtion:NDBDown:STATe` on page 103

`CALC:MARK1:FUNC:NDBD 3dB`, see `CALCulate<n>:MARKer<m>:FUNCtion:NDBDown` on page 100

`CALC:MARK1:FUNC:NDBD:RES?`, see `CALCulate<n>:MARKer<m>:FUNCtion:NDBDown:RESult?` on page 102

`CALC:MARK:FUNC:NDBD:QFAC?`, see `CALCulate<n>:MARKer<m>:FUNCtion:NDBDown:QFACTOR` on page 102

CALC:MARK1:FUNC:NDBD:FREQ? (span > 0), see [CALCulate<n>:MARKer<m>:FUNCTION:NDBDown:FREQuency?](#) on page 101

CALC:MARK1:FUNC:NDBD:TIME? (span = 0), see [CALCulate<n>:MARKer<m>:FUNCTION:NDBDown:TIME?](#) on page 103

Marker Peak List

Opens the "Peak List" submenu to define criteria for the sort order and the contents of the peak list. For each listed peak the frequency ("Stimulus") and level ("Response") values are given. In addition, the peaks are indicated in the trace display. A maximum of 50 entries are listed.

Remote command:

[CALCulate<n>:MARKer<m>:FUNCTION:FPEaks:COUNT?](#) on page 98

[CALCulate<n>:MARKer<m>:FUNCTION:FPEaks:X](#) on page 99

[CALCulate<n>:MARKer<m>:FUNCTION:FPEaks:Y?](#) on page 100

Peak List On/Off ← Marker Peak List

Activates/deactivates the marker peak list. If activated, the peak list is displayed and the peaks are indicated in the trace display.

Remote command:

[CALCulate<n>:MARKer<m>:FUNCTION:FPEaks:STAT](#) on page 95

Sort Mode Freq/Lvl ← Marker Peak List

Defines the criteria for sorting:

"Freq" sorting in ascending order of frequency values (span > 0) or time values (span = 0)

"Lvl" sorting in ascending order of the level

Remote command:

[CALCulate<n>:MARKer<m>:FUNCTION:FPEaks:SORT](#) on page 99

Max Peak Count ← Marker Peak List

Defines the maximum number of peaks to be determined and displayed.

Remote command:

[CALCulate<n>:MARKer<m>:FUNCTION:FPEaks:LIST:SIZE](#) on page 94

Peak Excursion ← Marker Peak List

Opens an edit dialog box for level measurements to enter the minimum level value by which a signal must rise or fall so that it will be identified as a maximum or a minimum by the search functions. Entries from 0 dB to 80 dB are allowed; the resolution is 0.1 dB. The default setting for the peak excursion is 6 dB.

For more information see "Specifying the suitable peak excursion" and "Effect of different peak excursion settings".

Remote command:

[CALCulate<n>:MARKer<m>:PEXCursion](#) on page 104

Left Limit ← Marker Peak List

Opens an edit dialog box to enter a value for the lower limit (left vertical line: S1 for span > 0; T1 for zero span). The search is performed between the lines of the left and right limit (see also [Right Limit](#) softkey).

Remote command:

[CALCulate<n>:MARKer<m>:X:SLIMits:LEFT](#) on page 106

Right Limit ← Marker Peak List

Opens an edit dialog box to enter a value for the upper limit (left vertical line: S2 for span > 0; T2 for zero span). The search is performed between the lines of the left and right limit (see also [Left Limit](#) softkey). If no value is set, the upper limit corresponds to the stop frequency.

Remote command:

[CALCulate<n>:MARKer<m>:X:SLIMits:RIGHT](#) on page 106

Threshold ← Marker Peak List

Opens an edit dialog box to define the threshold line. The threshold line represents the lower level limit for a "Peak" search and the upper level limit for a "Min" search.

Remote command:

[CALCulate<n>:THReshold:STATe](#) on page 97

[CALCulate<n>:THReshold](#) on page 96

ASCII File Export ← Marker Peak List

Opens the "ASCII File Export Name" dialog box and saves the active peak list in ASCII format to the specified file and directory.

The file consists of the header containing important scaling parameters and a data section containing the marker data. For details on an ASCII file see [Chapter 2.1.11, "ASCII File Export Format"](#), on page 23.

This format can be processed by spreadsheet calculation programs, e.g. MS-Excel. It is necessary to define ';' as a separator for the data import. Different language versions of evaluation programs may require a different handling of the decimal point. It is therefore possible to select between separators '.' (decimal point) and ',' (comma) using the "Decim Sep" softkey (see ["Decim Sep"](#) on page 63).

Remote command:

[FORMat:DEXPort:DSEParator](#) on page 185

[MMEMory:STORe<n>:LIST](#) on page 183

Decim Sep ← Marker Peak List

Selects the decimal separator with floating-point numerals for the ASCII Trace export to support evaluation programs (e.g. MS-Excel) in different languages. The values '.' (decimal point) and ',' (comma) can be set.

Remote command:

[FORMat:DEXPort:DSEParator](#) on page 185

Marker Number ← Marker Peak List

If enabled, the determined peaks are indicated by their corresponding marker number in the trace display.

Remote command:

`CALCulate<n>:MARKer<m>:FUNction:FPEaks:ANNotation:LABel:STATe`
on page 94

3.2 Remote Commands of the FM Stereo Option (R&S FSV-K7S)

In this section, all remote control commands specific to the FM Stereo option are described in detail.

In addition to these, all remote control commands described for the analog Demodulation option (K7) are available, as well (see [Chapter 2.3, "Remote Commands of the Analog Demodulation \(R&S FSV-K7\)"](#), on page 81).

For details on conventions used in this chapter refer to [Chapter 2.3.1, "Notation"](#), on page 82.

For further information on analyzer or basic settings commands, refer to the corresponding subsystem in the base unit description.

Subsystems for FM Stereo (R&S FSV-K7S)

3.2.1	Notation.....	227
3.2.2	CALCulate:MARKer:FUNction Subsystem (FM Stereo Option, R&S FSV-K7S).....	230
3.2.3	SENSE Subsystem.....	235
3.2.4	[SENSe:]SFM:<ChannelType> Subsystem.....	236
3.2.5	TRIGger Subsystem (FM Stereo, R&S FSV-K7S).....	245
3.2.6	UNIT Subsystem (FM Stereo, R&S FSV-K7S).....	249

3.2.1 Notation

In the following sections, all commands implemented in the instrument are first listed and then described in detail, arranged according to the command subsystems. The notation is adapted to the SCPI standard. The SCPI conformity information is included in the individual description of the commands.

Individual Description

The individual description contains the complete notation of the command. An example for each command, the *RST value and the SCPI information are included as well.

The options and operating modes for which a command can be used are indicated by the following abbreviations:

Abbreviation	Description
A	spectrum analysis

Remote Commands of the FM Stereo Option (R&S FSV-K7S)

A-F	spectrum analysis – span > 0 only (frequency mode)
A-T	spectrum analysis – zero span only (time mode)
ADEMODO	analog demodulation (option R&S FSV-K7)
BT	Bluetooth (option R&S FSV-K8)
CDMA	CDMA 2000 base station measurements (option R&S FSV-K82)
EVDO	1xEV-DO base station analysis (option R&S FSV-K84)
GSM	GSM/Edge measurements (option R&S FSV-K10)
IQ	IQ Analyzer mode
OFDM	WiMAX IEEE 802.16 OFDM measurements (option R&S FSV-K93)
OFDMA/WiBro	WiMAX IEEE 802.16e OFDMA/WiBro measurements (option R&S FSV-K93)
NF	Noise Figure measurements (R&S FSV-K30)
PHN	Phase Noise measurements (R&S FSV-K40)
PSM	Power Sensor measurements (option R&S FSV-K9)
SFM	Stereo FM measurements (option R&S FSV-K7S)
SPECM	Spectrogram mode (option R&S FSV-K14)
TDS	TD-SCDMA base station / UE measurements (option R&S FSV-K76/K77)
VSA	Vector Signal Analysis (option R&S FSV-K70)
WCDMA	3GPP Base Station measurements (option R&S FSV-K72), 3GPP UE measurements (option R&S FSV-K73)
WLAN	WLAN TX measurements (option R&S FSV-K91)



The spectrum analysis mode is implemented in the basic unit. For the other modes, the corresponding options are required.

Upper/Lower Case Notation

Upper/lower case letters are used to mark the long or short form of the key words of a command in the description. The instrument itself does not distinguish between upper and lower case letters.

Special Characters

	A selection of key words with an identical effect exists for several commands. These keywords are indicated in the same line; they are separated by a vertical stroke. Only one of these keywords needs to be included in the header of the command. The effect of the command is independent of which of the keywords is used.
--	---

Example:

```
SENSe:FREQuency:CW|:FIXed
```

The two following commands with identical meaning can be created. They set the frequency of the fixed frequency signal to 1 kHz:

```
SENSe:FREQuency:CW 1E3
```

```
SENSe:FREQuency:FIXed 1E3
```

A vertical stroke in parameter indications marks alternative possibilities in the sense of "or". The effect of the command differs, depending on which parameter is used.

Example: Selection of the parameters for the command

```
[SENSe<1...4>:]AVERAge<1...4>:TYPE VIDEo | LINear
```

[]	Key words in square brackets can be omitted when composing the header. The full command length must be accepted by the instrument for reasons of compatibility with the SCPI standards. Parameters in square brackets can be incorporated optionally in the command or omitted as well.
----	---

{}	Parameters in braces can be incorporated optionally in the command, either not at all, once or several times.
----	---

Description of Parameters

Due to the standardization, the parameter section of SCPI commands consists always of the same syntactical elements. SCPI has therefore specified a series of definitions, which are used in the tables of commands. In the tables, these established definitions are indicated in angled brackets (<...>) and is briefly explained in the following.

For details see the chapter "SCPI Command Structure" in the base unit description.

<Boolean>

This keyword refers to parameters which can adopt two states, "on" and "off". The "off" state may either be indicated by the keyword OFF or by the numeric value 0, the "on" state is indicated by ON or any numeric value other than zero. Parameter queries are always returned the numeric value 0 or 1.

<numeric_value> <num>

These keywords mark parameters which may be entered as numeric values or be set using specific keywords (character data). The following keywords given below are permitted:

- MAXimum: This keyword sets the parameter to the largest possible value.
- MINimum: This keyword sets the parameter to the smallest possible value.
- DEFault: This keyword is used to reset the parameter to its default value.
- UP: This keyword increments the parameter value.
- DOWN: This keyword decrements the parameter value.

The numeric values associated to MAXimum/MINimum/DEFault can be queried by adding the corresponding keywords to the command. They must be entered following the quotation mark.

Example:

```
SENSe:FREQuency:CENTer? MAXimum
```

Returns the maximum possible numeric value of the center frequency as result.

<arbitrary block program data>

This keyword is provided for commands the parameters of which consist of a binary data block.

3.2.2 CALCulate:MARKer:FUNctIon Subsystem (FM Stereo Option, R&S FSV-K7S)

The CALCulate:MARKer:FUNctIon subsystem contains the marker functions for the option FM Stereo, R&S FSV-K7S.

CALCulate<n>:MARKer:FUNctIon:DFD[:STATe].....	230
CALCulate<n>:MARKer:FUNctIon:DFD:UNIT.....	230
CALCulate<n>:MARKer:FUNctIon:DFD[:RESult<m>]?.....	231
CALCulate<n>:MARKer:FUNctIon:DFD:SEARChsignal ONCE.....	231
CALCulate<n>:MARKer:FUNctIon:IMD[:STATe].....	232
CALCulate<n>:MARKer:FUNctIon:IMD:UNIT.....	232
CALCulate<n>:MARKer:FUNctIon:IMD[:RESult<m>]?.....	232
CALCulate<n>:MARKer:FUNctIon:IMD:SEARChsignal ONCE.....	233
CALCulate<n>:MARKer:FUNctIon:SFM[:RESult<m>]?.....	233
CALCulate<n>:MARKer:FUNctIon:SFM:<ChannelType>[:RESult<m>]?.....	234

CALCulate<n>:MARKer:FUNctIon:DFD[:STATe] <State>

This command activates difference frequency distortion measurement in the specified window.

Suffix:

<n> 1...4
 window

Parameters:

<State> **ON | OFF**
 *RST: OFF

Example:

```
CALC:MARK:FUNC:DFD:ON
```

Mode:

SFM

Manual operation: See "Diff.Freq.Distortion (On/Off)" on page 222

CALCulate<n>:MARKer:FUNctIon:DFD:UNIT <ResultUnit>

This command defines the unit for the difference frequency distortion measurement results.

Suffix:	
<n>	1...4 irrelevant
Parameters:	
<ResultUnit>	PCT DB *RST: PCT
Example:	CALC:MARK:FUNC:DFD:UNIT DB
Mode:	SFM
Manual operation:	See " Unit (% / DB) " on page 222

CALCulate<n>:MARKer:FUNCtion:DFD[:RESult<m>]?

This command queries the result of the difference frequency distortion measurement in the specified window.

Suffix:	
<n>	1...4 window
<m>	1...6 irrelevant
Return values:	
<Result>	<dd2>,<dd3> The difference frequency distortion factors of 2nd and 3rd order (see " Diff.Freq.Distortion " on page 221)
Example:	CALC:MARK:FUNC:DFD:RES?
Usage:	Query only
Mode:	SFM

CALCulate<n>:MARKer:FUNCtion:DFD:SEARChsignal ONCE

This command starts the search of the signals required for the difference frequency distortion measurement in the specified window.

Suffix:	
<n>	1...4 window
Example:	CALC:MARK:FUNC:DFD:SEAR ONCE
Usage:	Event
Mode:	SFM
Manual operation:	See " Search Signals " on page 223

CALCulate<n>:MARKer:FUNCtion:IMD[:STATe] <State>

This command activates intermodulation distortion measurement in the specified window.

Suffix:

<n> 1...4
window

Parameters:

<State> **ON | OFF**
*RST: OFF

Example: CALC:MARK:FUNC:IMD:ON

Mode: SFM

Manual operation: See "[Intermod.Distortion \(On/Off\)](#)" on page 224

CALCulate<n>:MARKer:FUNCtion:IMD:UNIT <ResultUnit>

This command defines the unit for the intermodulation distortion measurement results.

Suffix:

<n> 1...4
irrelevant

Parameters:

<ResultUnit> **PCT | DB**
*RST: PCT

Example: CALC:MARK:FUNC:IMD:UNIT DB

Mode: SFM

Manual operation: See "[Unit \(% / DB\)](#)" on page 224

CALCulate<n>:MARKer:FUNCtion:IMD[:RESult<m>]?

This command queries the result of the intermodulation distortion measurement in the specified window.

Suffix:

<n> 1...4
window

<m> 1...6
irrelevant

Return values:

<Result> <dm2>,<dm3>
The modulation factors of 2nd and 3rd order

Example: CALC:MARK:FUNC:IMD:RES?

Usage: Query only

Mode: SFM

CALCulate<n>:MARKer:FUNCtion:IMD:SEARChsignal ONCE

This command starts the search of the signals required for the intermodulation distortion measurement in the specified window.

Suffix:

<n> 1...4
window

Example: CALC:MARK:FUNC:IMD:SEAR ONCE

Usage: Event

Mode: SFM

Manual operation: See "[Search Signals](#)" on page 224

CALCulate<n>:MARKer:FUNCtion:SFM[:RESult<m>]? <ResultType>

This command queries the results of the stereo measurement.

Suffix:

<n> 1...4
window

Query parameters:

<ResultType> SUMMary | FCARrier | XTALk

SUMMary

Returns all results of the measurement.

FCARrier

Returns only the carrier frequency.

XTALk

Returns crosstalk between left and right channels in dB:
 $-20 \log(\text{Left [kHz]} / \text{Right[kHz]})$ dB

Return values:

<SUMMary> <Absolute deviation>, <Relative deviation>, <SINAD>, <THD>,
<Modulation frequency>

The results consist of the described 5 values for each channel, separated by commas.

Note: if one of the result values is not available, $9.91E+37$ is inserted for the missing value.

To obtain the results for an individual channel, or only individual results, use the specific commands:

[CALCulate<n>:MARKer:FUNCtion:SFM:
<ChannelType>\[:RESult<m>\]? on page 234](#)

<FCARrier> The carrier frequency is returned.

Example: CALC1:MARK:FUNC:SFM:RES?

Usage: Query only

Mode: SFM

**CALCulate<n>:MARKer:FUNCTION:SFM:<ChannelType>[:RESult<m>]?
<MeasType>**

This command queries the results of the measurement type for the selected channel in the specified window.

Suffix:

<n> 1...4
window

<ChannelType> LEFT | RIGHT | MPX | MONO | STEReo | RDS | PILot
Channel type for which the command is performed.

Query parameters:

<MeasType> ALL | ADEV | RDEV | SINad | THD | AFRequency

ALL

All available measurement values

ADEV

The absolute deviation

RDEV

The relative deviation

SINad

The signal-to-noise-and-distortion value

THD

Total harmonic distortion

AFRequency

Audio frequency

*RST: ALL

Return values:

<Result> Measurement value according to the specified measurement type.

Note: if the specified result value is not available, a "Query Error" is returned. If all result values are queried (query parameter "ALL"), and one of them is not available, $9.91E+37$ is inserted for the missing value.

Example:

CALC1:MARK:FUNC:SFM:LEFT? THD

Queries the total harmonic distortion for the left stereo channel.

Usage: Query only

Mode: SFM

3.2.3 SENSE Subsystem

The SENSE subsystem controls the essential parameters of the stereo FM demodulator. In accordance with the SCPI standard, the keyword SENSE is optional for this reason, which means that it is not necessary to include the SENSE node in command sequences.

[SENSe:]SFM:FILTer<n>:AOFF.....	235
[SENSe:]SFM:STATe.....	235
[SENSe:]SFM:REFerence.....	235

[SENSe:]SFM:FILTer<n>:AOFF

This command switches all AF filters off.

Suffix:

<n> 1...4
 window

Example: SENS:SFM:FILT:AOFF

Usage: Event

Mode: SFM

[SENSe:]SFM:STATe <State>

This command switches between Stereo FM and Spectrum mode.

Parameters:

<State> **ON | OFF**
 *RST: OFF

Example: SFM:STAT ON

Mode: SFM

[SENSe:]SFM:REFerence <Level>

This command defines the reference deviation required for relative deviation measurements. Alternatively, it can be defined automatically, see e.g. [SENSe:]SFM:<ChannelType>:RSUMmary:REFerence[:AUTO] ONCE on page 244

Parameters:

<Level> **<numeric value> in Hz or dBm**
 *RST: -10.0 dBm

Example: SFM:REF 2Hz

Mode: SFM

Manual operation: See "Result Summary Setup" on page 196

3.2.4 [SENSe:]SFM:<ChannelType> Subsystem

The [SENSe:]SFM:<ChannelType> subsystem contains commands for the definition of frequency and level settings when measuring the specific channels of FM stereo signals.

[SENSe:]SFM:<ChannelType>:AFSPectrum:TYPE.....	236
[SENSe:]SFM:<ChannelType>:AFSPectrum:RESult?.....	237
[SENSe:]SFM:<ChannelType>:FILTer:AWeighted[:STATe].....	237
[SENSe:]SFM:<ChannelType>:FILTer:CCIT:STATe.....	237
[SENSe:]SFM:<ChannelType>:FILTer:CCIR[:UNWeighted[:STATe].....	238
[SENSe:]SFM:<ChannelType>:FILTer:CCIR:WEIGhted[:STATe].....	238
[SENSe:]SFM:<ChannelType>:FILTer:COUPling.....	239
[SENSe:]SFM:<ChannelType>:FILTer:DEMPHasis:STATe.....	239
[SENSe:]SFM:<ChannelType>:FILTer:DEMPHasis:TCONstant.....	239
[SENSe:]SFM:<ChannelType>:FILTer:HPASs:STATe.....	240
[SENSe:]SFM:<ChannelType>:FILTer:HPASs:FREQUency.....	240
[SENSe:]SFM:<ChannelType>:FILTer:LPASs:STATe.....	240
[SENSe:]SFM:<ChannelType>:FILTer:LPASs:FREQUency.....	241
[SENSe:]SFM:<ChannelType>:FILTer:LPASs:FREQUency[:ABSolute].....	241
[SENSe:]SFM:<ChannelType>:FILTer:LPASs:FREQUency:RELative.....	241
[SENSe:]SFM:<ChannelType>:RSUMmary:COUPling.....	242
[SENSe:]SFM:<ChannelType>:RSUMmary:DETEctor[:FUNCTion].....	242
[SENSe:]SFM:<ChannelType>:RSUMmary:MODE.....	243
[SENSe:]SFM:<ChannelType>:RSUMmary:REFerence[:AUTO] ONCE.....	244
[SENSe:]SFM:<ChannelType>:TDOmain:RESult?.....	244
[SENSe:]SFM:<ChannelType>:TDOmain:TYPE.....	244

[SENSe:]SFM:<ChannelType>:AFSPectrum:TYPE <TraceMode>

This command selects the trace modes of the FM stereo AF spectrum to be measured simultaneously. For each trace a mode can be defined, however only if the specified channel is currently displayed in one of the four screens. If a trace mode is set for a channel that is not displayed, a query error is generated.

Suffix:

<ChannelType> LEFT | RIGHT | MPX | MONO | STEReo | RDS | PILot
Channel type for which the command is performed.

Parameters:

<TraceMode> <TraceMode1>, <TraceMode2>, <TraceMode3>, <Trace-
Mode4>, <TraceMode5>, <TraceMode6>

WRITE | AVERAGE | MAXHold | MINHold | VIEW | OFF

For details on trace modes see [Chapter 2.3.6.1, "Trace Mode Result Types"](#), on page 118.

*RST: OFF,OFF,OFF,OFF,OFF,OFF

Example:

SFM:LEFT:AFSP:TYPE WRIT,OFF,AVER

Mode:

SFM

[SENSe:]SFM:<ChannelType>:AFSPectrum:RESult? <TraceMode>

This command reads the AF spectrum result data of the FM stereo signal in the specified trace mode. The data format of the output data block is defined by the FORMat command (see [Chapter 2.3.6.2, "Formats for Returned Values: ASCII Format and Binary Format"](#), on page 118).

The output units are described in [CALCulate<n>:MARKer<m>:PEXCursion](#) on page 104.

Suffix:

<ChannelType> LEFT | RIGHT | MPX | MONO | STEReo | RDS | PILot
Channel type for which the command is performed.

Query parameters:

<TraceMode> WRITe

At least one screen must display a channel with the specified channel type that has the trace mode "Write" specified using [\[SENSe:\]ADEMod:AM\[:ABSolute\] \[:TDOMain\] \[:TYPE\]](#) on page 125. Otherwise a query error is generated.

Example:

SFM:LEFT:AFSP:RES MINH

Returns the minimum value in the left channel after a series of measurements.

Usage:

Query only

Mode:

SFM

[SENSe:]SFM:<ChannelType>:FILTer:AWEighted[:STATe] <State>

This command activates/deactivates the weighted CCIR filter for the specified channel type.

For details on the weighted "A" filter see ["A Weighted"](#) on page 33.

Suffix:

<ChannelType> LEFT | RIGHT | MPX | MONO | STEReo | RDS | PILot
Channel type for which the command is performed.

Parameters:

<State> ON | OFF

*RST: OFF

Example:

SFM:LEFT:FILT:AWEI ON

Mode:

SFM

Manual operation: See ["A Weighted"](#) on page 33

[SENSe:]SFM:<ChannelType>:FILTer:CCITt:STATe <State>

This command activates/deactivates the CCIT (CCIT P.53) weighting filter for the specified channel type.

For details on the CCIT filter see ["CCITT"](#) on page 32.

Suffix:

<ChannelType> LEFT | RIGHT | MPX | MONO | STEReo | RDS | PILot
Channel type for which the command is performed.

Parameters:

<State> ON | OFF
*RST: OFF

Example:

SFM:LEFT:FILT:CCIT:STAT ON

Mode:

SFM

Manual operation: See ["CCITT"](#) on page 32

[SENSe:]SFM:<ChannelType>:FILTer:CCIR[:UNWeighted][:STATE] <State>

This command activates/deactivates the unweighted CCIR filter for the specified channel type.

For details on the unweighted CCIR filter see ["CCIR Unweighted"](#) on page 32.

Suffix:

<ChannelType> LEFT | RIGHT | MPX | MONO | STEReo | RDS | PILot
Channel type for which the command is performed.

Parameters:

<State> ON | OFF
*RST: OFF

Example:

SFM:LEFT:FILT:CCIR ON

Mode:

SFM

Manual operation: See ["CCIR Unweighted"](#) on page 32

[SENSe:]SFM:<ChannelType>:FILTer:CCIR:WEIGHted[:STATE] <State>

This command activates/deactivates the weighted CCIR filter for the specified channel type.

For details on the weighted CCIR filter see ["CCIR Weighted"](#) on page 33.

Suffix:

<ChannelType> LEFT | RIGHT | MPX | MONO | STEReo | RDS | PILot
Channel type for which the command is performed.

Parameters:

<State> ON | OFF
*RST: OFF

Example:

SFM:LEFT:FILT:CCIR:WEIG ON

Mode:

SFM

Manual operation: See ["CCIR Weighted"](#) on page 33

[SENSe:]SFM:<ChannelType>:FILTer:COUPling <State>

This command couples the filter settings for the specified channel type to other channels. The filter settings for all channels for which this setting is set to "ON" are defined identically.

Suffix:

<ChannelType> LEFT | RIGHT | MPX | MONO | STEReo | RDS | PILot
Channel type for which the command is performed.

Parameters:

<State> ON | OFF
*RST: OFF

Example: SFM:LEFT:FILT:COUP ON

Mode: SFM

[SENSe:]SFM:<ChannelType>:FILTer:DEMPHasis:STATe <State>

This command activates/deactivates the selected deemphasis for the specified channel type.

Suffix:

<ChannelType> LEFT | RIGHT | MPX | MONO | STEReo | RDS | PILot
Channel type for which the command is performed.

Parameters:

<State> ON | OFF
*RST: OFF

Example: SFM:LEFT:FILT:DEMP:STAT ON

Mode: SFM

Manual operation: See "[Deemphasis](#)" on page 33

[SENSe:]SFM:<ChannelType>:FILTer:DEMPHasis:TCONstant <Value>

This command selects the deemphasis for the specified channel type. For details on deemphasis refer to "[Deemphasis](#)" on page 33.

Suffix:

<ChannelType> LEFT | RIGHT | MPX | MONO | STEReo | RDS | PILot
Channel type for which the command is performed.

Parameters:

<Value> 25 us | 50 us | 75 us | 750 us
*RST: 50 us

Example: SFM:LEFT:FILT:DEMP:TCON 75us

Mode: SFM

Manual operation: See "[Deemphasis](#)" on page 33

[SENSe:]SFM:<ChannelType>:FILTer:HPASs:STATe <State>

This command activates/deactivates the selected high pass filter for the specified channel type.

For details on the high pass filter refer to "[High Pass](#)" on page 31.

Suffix:

<ChannelType> LEFT | RIGHT | MPX | MONO | STEReo | RDS | PILot
Channel type for which the command is performed.

Parameters:

<State> ON | OFF
*RST: OFF

Example: SFM:LEFT:FILT:HPAS:STAT ON

Mode: SFM

[SENSe:]SFM:<ChannelType>:FILTer:HPASs:FREQUency <FilterType>

This command selects the high pass filter type for the specified channel type. For details on filters refer to "[Deemphasis](#)" on page 33.

Suffix:

<ChannelType> LEFT | RIGHT | MPX | MONO | STEReo | RDS | PILot
Channel type for which the command is performed.

Parameters:

<FilterType> Range: 50 to 300
*RST: 300Hz
Default unit: Hz

Example: SFM:LEFT:FILT:HPAS:FREQ 300Hz

Mode: SFM

[SENSe:]SFM:<ChannelType>:FILTer:LPASs:STATe <State>

This command activates the low pass filter for the specified channel type.

For details on the low pass filter refer to "[Low Pass](#)" on page 31.

Suffix:

<ChannelType> LEFT | RIGHT | MPX | MONO | STEReo | RDS | PILot
Channel type for which the command is performed.

Parameters:

<State> ON | OFF
*RST: OFF

Example: SFM:LEFT:FILT:LPAS:STAT ON

Mode: SFM

Manual operation: See "[Low Pass](#)" on page 31

[SENSe:]SFM:<ChannelType>:FILTer:LPASs:FREQUency <Level>

This command activates/deactivates the selected low pass filter for the specified channel type.

For details on the low pass filter refer to "[Low Pass](#)" on page 31.

Suffix:

<ChannelType> LEFT | RIGHT | MPX | MONO | STEReo | RDS | PILot
Channel type for which the command is performed.

Parameters:

<Level> <numeric value>
*RST: RST value

Example: SFM:LEFT:FILT:LPAS:FREQ 10

Mode: SFM

Manual operation: See "[Low Pass](#)" on page 31

[SENSe:]SFM:<ChannelType>:FILTer:LPASs:FREQUency[:ABSolute] <FilterType>

This command selects the absolute low pass filter type in the specified window. For details on filters refer to "[Low Pass](#)" on page 31.

For details about the demodulation bandwidth range refer to "[Demod BW](#)" on page 30.

Suffix:

<n> 1...4
window

Parameters:

<FilterType> 3kHz | 15kHz | 150kHz
*RST: 15kHz

Example: SFM:LEFT:FILT:LPAS:FREQ 150kHz
Selects the low pass filter for the demodulation bandwidth range from 400 kHz to 16 MHz.

Mode: SFM

[SENSe:]SFM:<ChannelType>:FILTer:LPASs:FREQUency:RELAtive <FilterType>

This command selects the relative low pass filter type in the specified window. For details on filters refer to [Low Pass](#) softkey.

For details about the demodulation bandwidth range refer to "[Demod BW](#)" on page 30.

Suffix:

<n> 1...4
window

Parameters:

<FilterType> 5PCT | 10PCT | 25PCT
 *RST: 25PCT

Example:

SFM:LEFT:FILT:LPAS:FREQ 25PCT
 Selects the low pass filter as 25 % of the demodulation bandwidth.

Mode: SFM

[SENSe:]SFM:<ChannelType>:RSUMmary:COUPling <State>

This command couples the channel settings to other channels, i.e. channels for which this command is set to "ON" are configured identically.

Suffix:

<ChannelType> LEFT | RIGHT | MPX | MONO | STEReo | RDS | PILot
 Channel type for which the command is performed.

Parameters:

<State> ON | OFF
 *RST: OFF

Example:

SFM:LEFT:RSUM:COUP ON

Mode: SFM

Manual operation: See ["Result Summary Setup"](#) on page 196
 See ["Coupled"](#) on page 197

[SENSe:]SFM:<ChannelType>:RSUMmary:DETEctor[:FUNCTion] <Detector>

This command defines the detector used to determine the deviation value of the left channel of the FM stereo signal in the result summary.

Suffix:

<ChannelType> LEFT | RIGHT | MPX | MONO | STEReo | RDS | PILot
 Channel type for which the command is performed.

Parameters:

<Detector> RMS | SRMS | PPEak | NPEak | PAverage | QPEak | SQPeak
RMS
 RMS
SRMS
 RMS*SQRT2
PPEak
 Positive peak
NPEak
 Negative peak
PAverage
 ±Peak/2

QPEak

Quasipeak CCIR

SQPeak

Quasipeak*SQRT2

*RST: PAverage

Example: SFM:LEFT:RSUM:DET PPE
Sets the detector for the left channel to positive peak.

Mode: SFM

Manual operation: See "Result Summary Setup" on page 196
See "Detector" on page 197

[SENSe:]SFM:<ChannelType>:RSUMmary:MODE <Mode>

This command defines the result summary mode for the absolute and relative deviation. It does not affect the trace mode.

Suffix:

<ChannelType> LEFT | RIGHT | MPX | MONO | STEReo | RDS | PILot
Channel type for which the command is performed.

Parameters:

<Mode> WRITe | AVERAge | PHOLd

WRITe

Clear Write: Overwrite mode; the summary is overwritten by each sweep.

AVERAge

The average is formed over several sweeps. The number of sweeps is defined by the sweep count (see [SENSe:]SWEep:COUNT on page 155 or [SENSe:]AVERAge<n>:COUNT on page 157).

PHOLd

Peak hold: The maximum values are determined over several sweeps and displayed. The number of sweeps is defined by the sweep count (see [SENSe:]SWEep:COUNT on page 155 or [SENSe:]AVERAge<n>:COUNT on page 157).

*RST: WRITe

Example: AVER:COUN 16
Sets the number of measurements to 16.
SFM:LEFT:RSUM:MODE PHOL
Sets the result summary mode for the left channel to peak hold. The maximum value during 16 measurements is displayed in the result summary.

Mode: SFM

Manual operation: See "Result Summary Setup" on page 196
See "Mode" on page 197

[SENSe:]SFM:<ChannelType>:RSUMmary:REFerence[:AUTO] ONCE

This command determines the reference deviation from the current channel measurement.

Suffix:

<ChannelType> LEFT | RIGHT | MPX | MONO | STEReo | RDS | PILot
Channel type for which the command is performed.

Example:

SFM:LEFT:RSUM:REF ONCE

Mode:

SFM

Manual operation:

See ["Result Summary Setup"](#) on page 196
See ["Meas To Ref"](#) on page 197

[SENSe:]SFM:<ChannelType>:TDOMain:RESult? <TraceMode>

This command reads the result data of the FM stereo signal in zero span in the specified trace mode. The data format of the output data block is defined by the FORMat command (see [Chapter 2.3.6.2, "Formats for Returned Values: ASCII Format and Binary Format"](#), on page 118).

The output units are described in [CALCulate<n>:MARKer<m>:PEXCursion](#) on page 104.

Suffix:

<ChannelType> LEFT | RIGHT | MPX | MONO | STEReo | RDS | PILot
Channel type for which the command is performed.

Query parameters:

<TraceMode> WRITe

At least one screen must display a left channel that has the trace mode "Write" specified using [\[SENSe:\]ADEMod:AM\[:ABSolute\]\[:TDOMain\]\[:TYPE\]](#) on page 125. Otherwise a query error is generated.

Example:

SFM:LEFT:TDOM:RES WRIT

Returns the current trace results in the left channel.

Usage:

Query only

Mode:

SFM

[SENSe:]SFM:<ChannelType>:TDOMain:TYPE <TraceMode>

This command selects the trace modes of the FM stereo signal to be measured simultaneously in zero span. For each trace a mode can be defined, however only if the specified channel is currently displayed in one of the four screens. If a trace mode is set for a channel that is not displayed, a query error is generated.

Suffix:

<ChannelType> LEFT | RIGHT | MPX | MONO | STEReo | RDS | PILot
Channel type for which the command is performed.

Parameters:

<TraceMode> <TraceMode1>, <TraceMode2>, <TraceMode3>, <TraceMode4>, <TraceMode5>, <TraceMode6>

WRITe | AVERage | MAXHold | MINHold | VIEW | OFF

For details on trace modes see [Chapter 2.3.6.1, "Trace Mode Result Types"](#), on page 118.

*RST: OFF,OFF,OFF,OFF,OFF,OFF

Example:

SFM:LEFT:TDOM:TYPE WRIT,OFF,AVER

Mode:

SFM

3.2.5 TRIGger Subsystem (FM Stereo, R&S FSV-K7S)

The TRIGger subsystem is used to synchronize instrument actions with events. It is thus possible to control and synchronize the start of a sweep.

Commands of the TRIGger Subsystem

TRIGger<n>[:SEQuence]:LEVel:SFM:LEFT.....	245
TRIGger<n>[:SEQuence]:LEVel:SFM:RIGHT.....	245
TRIGger<n>[:SEQuence]:LEVel:SFM:MPX.....	246
TRIGger<n>[:SEQuence]:LEVel:SFM:MONO.....	246
TRIGger<n>[:SEQuence]:LEVel:SFM:STEReo.....	247
TRIGger<n>[:SEQuence]:LEVel:SFM:RDS.....	247
TRIGger<n>[:SEQuence]:LEVel:SFM:PILot.....	247
TRIGger<n>[:SEQuence]:SOURce.....	248

TRIGger<n>[:SEQuence]:LEVel:SFM:LEFT <Level>

The command sets the level when the left stereo channel is used as trigger source.

Suffix:

<n> 1...4
irrelevant

Parameters:

<Level> Range: -10 to +10
*RST: 0 Hz
Default unit: MHz

Example:

TRIG:LEV:SFM:LEFT 2Hz

Sets the left stereo signal trigger threshold to 2 Hz.

Mode:

SFM

Manual operation: See "[Left](#)" on page 217

TRIGger<n>[:SEQuence]:LEVel:SFM:RIGHT <Level>

The command sets the level when the right stereo channel is used as trigger source.

Suffix:

<n> 1...4
irrelevant

Parameters:

<Level> Range: -10 to +10
*RST: 0 Hz
Default unit: MHz

Example:

TRIG:LEV:SFM:RIGH 2Hz
Sets the trigger threshold of the right stereo signal to 2 Hz.

Mode: SFM

Manual operation: See ["Right"](#) on page 217

TRIGger<n>[:SEQUENCE]:LEVEL:SFM:MPX <Level>

The command sets the level when the MPX stereo channel is used as trigger source.

Suffix:

<n> 1...4
irrelevant

Parameters:

<Level> Range: -10 to +10
*RST: 0 Hz
Default unit: MHz

Example:

TRIG:LEV:SFM:MPX 2Hz
Sets the trigger threshold of the MPX stereo signal to 2 Hz.

Mode: SFM

Manual operation: See ["MPX"](#) on page 217

TRIGger<n>[:SEQUENCE]:LEVEL:SFM:MONO <Level>

The command sets the level when the mono channel of a FM stereo signal is used as trigger source.

Suffix:

<n> 1...4
irrelevant

Parameters:

<Level> Range: -10 to +10
*RST: 0 Hz
Default unit: MHz

Example:

TRIG:LEV:SFM:MONO 2Hz
Sets the trigger threshold of the mono stereo signal to 2 Hz.

Mode: SFM

Manual operation: See ["Mono"](#) on page 218

TRIGger<n>[:SEquence]:LEVel:SFM:STEReo <Level>

The command sets the level when the stereo channel is used as trigger source.

Suffix:

<n> 1...4
 irrelevant

Parameters:

<Level> Range: -10 to +10
 *RST: 0 Hz
 Default unit: MHz

Example:

TRIG:LEV:SFM:STER 2Hz
Sets the trigger threshold of the stereo signal to 2 Hz.

Mode: SFM

Manual operation: See "Stereo" on page 218

TRIGger<n>[:SEquence]:LEVel:SFM:RDS <Level>

The command sets the level when the RDS stereo channel is used as trigger source.

Suffix:

<n> 1...4
 irrelevant

Parameters:

<Level> Range: -10 to +10
 *RST: 0 Hz
 Default unit: MHz

Example:

TRIG:LEV:SFM:RDS 2Hz
Sets the trigger threshold of the RDS stereo signal to 2 Hz.

Mode: SFM

Manual operation: See "RDS" on page 218

TRIGger<n>[:SEquence]:LEVel:SFM:PILot <Level>

The command sets the level when the pilot stereo channel is used as trigger source.

Suffix:

<n> 1...4
 irrelevant

Parameters:

<Level> Range: -10 to +10
 *RST: 0 Hz
 Default unit: MHz

Example:

TRIG:LEV:SFM:PIL 2Hz
Sets the trigger threshold of the pilot stereo signal to 2 Hz.

Mode: SFM
Manual operation: See "Pilot" on page 218

TRIGger<n>[:SEquence]:SOURce <Source>

This command selects the trigger source for the start of a sweep.

Suffix:

<n> 1...4
 irrelevant

Parameters:

<Source> IMMEDIATE | EXTERN | IFPOWER | AF | FM | AM | AMRelative |
 PM | TIME | SLEFt | SRIGHt | SMPX | SMONo | SSTereo |
 SRDS | SPILot

For details on trigger sources refer to the "[Trigger Source](#)" on page 216 softkey.

For triggering with AF, AM, AMRelative, FM, and PM trigger sources to be successful, the measurement time must cover at least 5 periods of the audio signal.

IMMEDIATE

Free Run (no trigger)

EXTERN

External trigger

IFPOWER

Triggering via signals which are outside the measurement channel

AF

Audio frequency trigger

FM

Triggering via FM frequency level

AM

Triggering via RF power signal

AMRelative

Triggering via AM signal

PM

Triggering via PM frequency level

TIME

Triggering according to repetition interval

SLEFt

Triggering via left stereo signal

SRIGHt

Triggering via right stereo signal

SMPX

Triggering via MPX stereo signal

SMONo

Triggering via mono stereo signal

SSTereo

Triggering via stereo FM signal

SRDS

Triggering via RDS stereo signal

SPILot

Triggering via pilot stereo signal

*RST: IMM

Example: TRIG:SEQ:SOUR:SRDS
Defines triggering on the RDS stereo signal.

Mode: SFM

3.2.6 UNIT Subsystem (FM Stereo, R&S FSV-K7S)

UNIT:ADEV <Unit>

Selects the unit for absolute deviation measurements.

Parameters:

<Unit> HZ | DBM
*RST: HZ

Example: UNIT:ADEV DBM

Mode: SFM

Manual operation: See "[Abs. Dev Unit \(kHz/dBm\)](#)" on page 36

UNIT:ANGLE <Unit>

This command selects the unit for angles (e.g. for PM display).

The unit is defined globally for all windows.

Suffix:

<n> irrelevant

Parameters:

<Unit> DEG | RAD
*RST: RAD

Example: UNIT:ANGL DEG

Mode: ADEMOD, SFM

UNIT:POWER <Unit>

This command selects the unit for power.

The unit is defined globally for all windows.

Suffix:

<n> irrelevant

Parameters:

<Unit> DBM | V | A | W | DBPW | WATT | DBUV | DBMV | VOLT |
DBUA | AMPere
*RST: dBm

Example:

UNIT:POW DBM
Sets the power unit to dBm.

Mode: A, ADEMOD, SFM, SPECM

UNIT:RDEV <Unit>

Selects the unit for relative deviation measurements.

Parameters:

<Unit> DB | PCT
*RST: HZ

Example:

UNIT:RDEV PCT

Mode: SFM

Manual operation: See "[Rel. Dev Unit \(dB / %\)](#)" on page 36

UNIT:THD <Mode>

Selects the unit for THD measurements.

Parameters:

<Mode> DB | PCT
*RST: DB

Example:

UNIT:THD PCT

Mode: ADEMOD, SFM

Manual operation: See "[Phase Unit \(Rad/Deg\)](#)" on page 35
See "[THD Unit \(% / DB\)](#)" on page 35

List of Commands

[SENSe:] [WINDow:] DETector<trace>[:FUNCTION]	159
[SENSe:] [WINDow:] DETector<trace>[:FUNCTION]:AUTO	159
[SENSe:] ADEMod:AM:RELative:AFSPectrum:RESult?	128
[SENSe:] ADEMod:AM:RELative:AFSPectrum[:TYPE]	127
[SENSe:] ADEMod:AM:RELative[:TDOMain]:RESult?	126
[SENSe:] ADEMod:AM:RELative[:TDOMain][:TYPE]	126
[SENSe:] ADEMod:AM[:ABSolute][:TDOMain]:RESult?	125
[SENSe:] ADEMod:AM[:ABSolute][:TDOMain][:TYPE]	125
[SENSe:] ADEMod:BANDwidth BWIDth:DEModulation	129
[SENSe:] ADEMod:BANDwidth BWIDth:DEModulation:TYPE	129
[SENSe:] ADEMod:CAPTure:DOFFset	120
[SENSe:] ADEMod:CAPTure:TIME	120
[SENSe:] ADEMod:CAPTure[:MODE]	121
[SENSe:] ADEMod:FM:AFSPectrum:RESult	131
[SENSe:] ADEMod:FM:AFSPectrum[:TYPE]	131
[SENSe:] ADEMod:FM:OFFSet	132
[SENSe:] ADEMod:FM[:TDOMain]:RESult	130
[SENSe:] ADEMod:FM[:TDOMain][:TYPE]	129
[SENSe:] ADEMod:MTIME	133
[SENSe:] ADEMod:PM:AFSPectrum:RESult	136
[SENSe:] ADEMod:PM:AFSPectrum[:TYPE]	135
[SENSe:] ADEMod:PM:RPOint[:X]	137
[SENSe:] ADEMod:PM[:TDOMain]:RESult	134
[SENSe:] ADEMod:PM[:TDOMain][:TYPE]	134
[SENSe:] ADEMod:RLENgth?	138
[SENSe:] ADEMod:SET	138
[SENSe:] ADEMod:SPECTrum:BANDwidth BWIDth[:RESolution]	140
[SENSe:] ADEMod:SPECTrum:RESult	140
[SENSe:] ADEMod:SPECTrum:SPAN:ZOOM	142
[SENSe:] ADEMod:SPECTrum:SPAN[:MAXimum]	141
[SENSe:] ADEMod:SPECTrum[:TYPE]	139
[SENSe:] ADEMod:SQUelch:LEVel	142
[SENSe:] ADEMod:SQUelch[:STATe]	142
[SENSe:] ADEMod:SRATe?	143
[SENSe:] ADEMod[:STATe]	121
[SENSe:] ADEMod<n>:AF:CENTer	121
[SENSe:] ADEMod<n>:AF:COUPling	122
[SENSe:] ADEMod<n>:AF:SPAN	122
[SENSe:] ADEMod<n>:AF:SPAN:FULL	123
[SENSe:] ADEMod<n>:AF:STARt	123
[SENSe:] ADEMod<n>:AF:STOP	124
[SENSe:] ADEMod<n>:ZOOM:LENgth	144
[SENSe:] ADEMod<n>:ZOOM:LENgth:MODE	145
[SENSe:] ADEMod<n>:ZOOM:STARt	144
[SENSe:] ADEMod<n>:ZOOM[:STATe]	143
[SENSe:] ADJust:ALL	145
[SENSe:] ADJust:CONFIguration:HYSTeresis:LOWer	145

[SENSe:]ADJust:CONFIguration:HYSteresis:UPPer.....	146
[SENSe:]ADJust:CONFIgure:LEVel:DURation.....	146
[SENSe:]ADJust:FREQUency.....	146
[SENSe:]ADJust:LEVel.....	147
[SENSe:]ADJust:SCALe:Y:AUTO[:CONTInuous].....	147
[SENSe:]AVERAge<n>:COUNT.....	157
[SENSe:]AVERAge<n>:TYPE.....	158
[SENSe:]BANDwidth:DEMod:TYPE.....	148
[SENSe:]BANDwidth BWIDth:DEMod.....	147
[SENSe:]FILTer<n>:AOFF.....	148
[SENSe:]FILTer<n>:AWEighted[:STATe].....	149
[SENSe:]FILTer<n>:CCIR:WEIGhted[:STATe].....	150
[SENSe:]FILTer<n>:CCIR[:UNWeighted][:STATe].....	150
[SENSe:]FILTer<n>:CCIT.....	149
[SENSe:]FILTer<n>:DEMPHasis:TCONstant.....	151
[SENSe:]FILTer<n>:DEMPHasis[:STATe].....	150
[SENSe:]FILTer<n>:HPASs:FREQUency.....	152
[SENSe:]FILTer<n>:HPASs[:STATe].....	151
[SENSe:]FILTer<n>:LPASs:FREQUency:RELative.....	153
[SENSe:]FILTer<n>:LPASs:FREQUency[:ABSolute].....	152
[SENSe:]FILTer<n>:LPASs[:STATe].....	152
[SENSe:]FREQUency:CENTer.....	153
[SENSe:]FREQUency:CENTer:STEP.....	154
[SENSe:]FREQUency:CENTer:STEP:LINK.....	154
[SENSe:]FREQUency:CENTer:STEP:LINK:FACTor.....	155
[SENSe:]SFM:<ChannelType>:AFSPectrum:RESult?.....	237
[SENSe:]SFM:<ChannelType>:AFSPectrum:TYPE.....	236
[SENSe:]SFM:<ChannelType>:FILTer:AWEighted[:STATe].....	237
[SENSe:]SFM:<ChannelType>:FILTer:CCIR:WEIGhted[:STATe].....	238
[SENSe:]SFM:<ChannelType>:FILTer:CCIR[:UNWeighted][:STATe].....	238
[SENSe:]SFM:<ChannelType>:FILTer:CCITt:STATe.....	237
[SENSe:]SFM:<ChannelType>:FILTer:COUPling.....	239
[SENSe:]SFM:<ChannelType>:FILTer:DEMPHasis:STATe.....	239
[SENSe:]SFM:<ChannelType>:FILTer:DEMPHasis:TCONstant.....	239
[SENSe:]SFM:<ChannelType>:FILTer:HPASs:FREQUency.....	240
[SENSe:]SFM:<ChannelType>:FILTer:HPASs:STATe.....	240
[SENSe:]SFM:<ChannelType>:FILTer:LPASs:FREQUency.....	241
[SENSe:]SFM:<ChannelType>:FILTer:LPASs:FREQUency:RELative.....	241
[SENSe:]SFM:<ChannelType>:FILTer:LPASs:FREQUency[:ABSolute].....	241
[SENSe:]SFM:<ChannelType>:FILTer:LPASs:STATe.....	240
[SENSe:]SFM:<ChannelType>:RSUMmary:COUPling.....	242
[SENSe:]SFM:<ChannelType>:RSUMmary:DETEctor[:FUNCTion].....	242
[SENSe:]SFM:<ChannelType>:RSUMmary:MODE.....	243
[SENSe:]SFM:<ChannelType>:RSUMmary:REFerence[:AUTO] ONCE.....	244
[SENSe:]SFM:<ChannelType>:TDOMain:RESult?.....	244
[SENSe:]SFM:<ChannelType>:TDOMain:TYPE.....	244
[SENSe:]SFM:FILTer<n>:AOFF.....	235
[SENSe:]SFM:REFerence.....	235
[SENSe:]SFM:STATe.....	235
[SENSe:]SWEep:COUNT.....	155

[SENSe:]SWEEp:EGATe:HOLDoff.....	156
[SENSe:]SWEEp:EGATe:POLarity.....	156
[SENSe:]SWEEp:EGATe:SOURce.....	156
[SENSe:]SWEEp:EGATe:TYPE.....	156
[SENSe:]SWEEp:POINts.....	157
[SENSe:]SWEEp:TIME.....	157
CALC:UNIT:THD.....	98
CALCulate<n>:DELTamarker<m>:FUNCTion:FIXed:RPOint:MAXimum[:PEAK].....	170
CALCulate<n>:DELTamarker<m>:FUNCTion:FIXed:RPOint:X.....	171
CALCulate<n>:DELTamarker<m>:FUNCTion:FIXed:RPOint:Y.....	171
CALCulate<n>:DELTamarker<m>:FUNCTion:FIXed[:STATe].....	172
CALCulate<n>:DELTamarker<m>:FUNCTion:PNOise:AUTO.....	173
CALCulate<n>:DELTamarker<m>:FUNCTion:PNOise[:STATe].....	172
CALCulate<n>:DELTamarker<m>:LINK.....	173
CALCulate<n>:DELTamarker<m>:MREF.....	174
CALCulate<n>:DELTamarker<m>:TRACe.....	174
CALCulate<n>:DELTamarker<m>:X.....	175
CALCulate<n>:DELTamarker<m>:X:RELative?.....	175
CALCulate<n>:DELTamarker<m>:Y?.....	176
CALCulate<n>:DELTamarker<m>[:STATe].....	174
CALCulate<n>:FEED.....	90
CALCulate<n>:FORMat.....	93
CALCulate<n>:MARKer:FUNCTion:ADEMod:AFRequency[:RESult<t>]?.....	85
CALCulate<n>:MARKer:FUNCTion:ADEMod:AM[:RESult<t>]?.....	86
CALCulate<n>:MARKer:FUNCTion:ADEMod:CARRier[:RESult<t>]?.....	87
CALCulate<n>:MARKer:FUNCTion:ADEMod:FERRor[:RESult<t>]?.....	87
CALCulate<n>:MARKer:FUNCTion:ADEMod:FM[:RESult<t>]?.....	88
CALCulate<n>:MARKer:FUNCTion:ADEMod:PM[:RESult<t>]?.....	89
CALCulate<n>:MARKer:FUNCTion:ADEMod:SINad:RESult<t>?.....	89
CALCulate<n>:MARKer:FUNCTion:ADEMod:THD:RESult<t>?.....	90
CALCulate<n>:MARKer:FUNCTion:DFD:SEARChsignal ONCE.....	231
CALCulate<n>:MARKer:FUNCTion:DFD:UNIT.....	230
CALCulate<n>:MARKer:FUNCTion:DFD[:RESult<m>]?.....	231
CALCulate<n>:MARKer:FUNCTion:DFD[:STATe].....	230
CALCulate<n>:MARKer:FUNCTion:IMD:SEARChsignal ONCE.....	233
CALCulate<n>:MARKer:FUNCTion:IMD:UNIT.....	232
CALCulate<n>:MARKer:FUNCTion:IMD[:RESult<m>]?.....	232
CALCulate<n>:MARKer:FUNCTion:IMD[:STATe].....	232
CALCulate<n>:MARKer:FUNCTion:SFM:<ChannelType>[:RESult<m>]?.....	234
CALCulate<n>:MARKer:FUNCTion:SFM[:RESult<m>]?.....	233
CALCulate<n>:MARKer<m>:AOFF.....	98
CALCulate<n>:MARKer<m>:FUNCTion:FPEaks:ANNOtation:LABel:STATe.....	94
CALCulate<n>:MARKer<m>:FUNCTion:FPEaks:COUNt?.....	98
CALCulate<n>:MARKer<m>:FUNCTion:FPEaks:LIST:SIZE.....	94
CALCulate<n>:MARKer<m>:FUNCTion:FPEaks:SORT.....	99
CALCulate<n>:MARKer<m>:FUNCTion:FPEaks:STAT.....	95
CALCulate<n>:MARKer<m>:FUNCTion:FPEaks:X.....	99
CALCulate<n>:MARKer<m>:FUNCTion:FPEaks:Y?.....	100
CALCulate<n>:MARKer<m>:FUNCTion:NDBDown.....	100
CALCulate<n>:MARKer<m>:FUNCTion:NDBDown:FREquency?.....	101

CALCulate<n>:MARKer<m>:FUNction:NDBDown:QFACTOR.....	102
CALCulate<n>:MARKer<m>:FUNction:NDBDown:RESult?.....	102
CALCulate<n>:MARKer<m>:FUNction:NDBDown:STATe.....	103
CALCulate<n>:MARKer<m>:FUNction:NDBDown:TIME?.....	103
CALCulate<n>:MARKer<m>:FUNction:PNOise.....	95
CALCulate<n>:MARKer<m>:FUNction:PNOise:RESult?.....	93
CALCulate<n>:MARKer<m>:FUNction:ZOOM.....	95
CALCulate<n>:MARKer<m>:LINK.....	96
CALCulate<n>:MARKer<m>:PEXCursion.....	104
CALCulate<n>:MARKer<m>:TRACe.....	105
CALCulate<n>:MARKer<m>:X.....	105
CALCulate<n>:MARKer<m>:X:SLIMits:LEFT.....	106
CALCulate<n>:MARKer<m>:X:SLIMits:RIGHT.....	106
CALCulate<n>:MARKer<m>:X:SLIMits[:STATe].....	107
CALCulate<n>:MARKer<m>:X:SSIZE.....	107
CALCulate<n>:MARKer<m>:Y?.....	107
CALCulate<n>:MARKer<m>[:STATe].....	104
CALCulate<n>:THReshold.....	96
CALCulate<n>:THReshold:STATe.....	97
CALCulate<n>:UNIT:ANGLE.....	97
CALCulate<n>:UNIT:POWER.....	97
DIAGnostic<n>:SERvice:NSOURce.....	185
DISPlay:MTABLE.....	109
DISPlay:WSElect?.....	115
DISPlay[:WINDow<n>]:SSElect?.....	110
DISPlay[:WINDow<n>]:STATe.....	109
DISPlay[:WINDow<n>]:TRACe<t>:MODE.....	110
DISPlay[:WINDow<n>]:TRACe<t>:Y:SPACing.....	114
DISPlay[:WINDow<n>]:TRACe<t>:Y[:SCALE].....	111
DISPlay[:WINDow<n>]:TRACe<t>:Y[:SCALE]:MODE.....	112
DISPlay[:WINDow<n>]:TRACe<t>:Y[:SCALE]:PDIVision.....	112
DISPlay[:WINDow<n>]:TRACe<t>:Y[:SCALE]:RLEVel.....	113
DISPlay[:WINDow<n>]:TRACe<t>:Y[:SCALE]:RLEVel:OFFSet.....	113
DISPlay[:WINDow<n>]:TRACe<t>:Y[:SCALE]:RPOSition.....	113
DISPlay[:WINDow<n>]:TRACe<t>:Y[:SCALE]:RVALue.....	114
DISPlay[:WINDow<n>]:TRACe<t>[:STATe].....	111
DISPlay[:WINDow<n>][:SUBWIndow<1 2>]:SElect.....	109
FORMat:DEXPort:DSEParator.....	185
FORMat:DEXPort:TRACes.....	161
FORMat[:DATA].....	184
INITiate<n>:CONMeas.....	185
INITiate<n>:CONTInuous.....	186
INITiate<n>[:IMMediate].....	186
INPut:ATTenuation.....	177
INPut:ATTenuation:AUTO.....	177
INPut:COUPling.....	178
INPut:DIQ:CDEvice.....	178
INPut:DIQ:RANGe:COUPling.....	179
INPut:DIQ:RANGe[:UPPer].....	179
INPut:DIQ:RANGe[:UPPer]:UNIT.....	180

INPut:DIQ:SRATe.....	180
INPut:EATT.....	181
INPut:EATT:AUTO.....	181
INPut:GAIN:STATe.....	181
INPut:IMPedance.....	182
INPut:SElect.....	182
INSTRument:NSElect <Mode>.....	116
INSTRument[:SElect].....	116
MMEMory:STORe<n>:LIST.....	183
MMEMory:STORe<n>:TRACe.....	183
OUTPut:DIQ.....	183
OUTPut:IF[:SOURce].....	184
OUTPut:TRIGger.....	184
PROBe:ID:PARTnumber?.....	116
PROBe:ID:SRNumber?.....	116
PROBe:SETup:MODE.....	117
PROBe:SETup:NAME?.....	117
PROBe:SETup:STATe?.....	117
PROBe[:STATe].....	117
SYSTem:DISPlay:UPDate.....	187
TRACe<n>[:DATA]?.....	160
TRIGger<n>[:SEquence]:BBPower:HOLDoff.....	163
TRIGger<n>[:SEquence]:HOLDoff[:TIME].....	163
TRIGger<n>[:SEquence]:IFPower:HOLDoff.....	163
TRIGger<n>[:SEquence]:IFPower:HYSTeresis.....	164
TRIGger<n>[:SEquence]:LEVel:AM:RELative.....	164
TRIGger<n>[:SEquence]:LEVel:AM[:ABSolute].....	164
TRIGger<n>[:SEquence]:LEVel:BBPower.....	165
TRIGger<n>[:SEquence]:LEVel:FM.....	165
TRIGger<n>[:SEquence]:LEVel:IFPower.....	165
TRIGger<n>[:SEquence]:LEVel:PM.....	166
TRIGger<n>[:SEquence]:LEVel:RFPower.....	166
TRIGger<n>[:SEquence]:LEVel:SFM:LEFT.....	245
TRIGger<n>[:SEquence]:LEVel:SFM:MONO.....	246
TRIGger<n>[:SEquence]:LEVel:SFM:MPX.....	246
TRIGger<n>[:SEquence]:LEVel:SFM:PILot.....	247
TRIGger<n>[:SEquence]:LEVel:SFM:RDS.....	247
TRIGger<n>[:SEquence]:LEVel:SFM:RIGHT.....	245
TRIGger<n>[:SEquence]:LEVel:SFM:STEReo.....	247
TRIGger<n>[:SEquence]:LEVel:VIDeo.....	167
TRIGger<n>[:SEquence]:SLOPe.....	167
TRIGger<n>[:SEquence]:SOURce.....	167
TRIGger<n>[:SEquence]:SOURce.....	248
TRIGger<n>[:SEquence]:TIME:RINTerval.....	166
UNIT:ADEV.....	249
UNIT:ANGLE.....	169
UNIT:ANGLE.....	249
UNIT:POWer.....	169
UNIT:POWer.....	249
UNIT:RDEV.....	250

UNIT:THD.....170
UNIT:THD.....250

Index

A

A Weighted	
Softkey	33, 54, 200, 214
Abs. Dev Unit	
softkey	36, 203, 208, 209
Active probes	
Activating	77
AF Auto Scale	
softkey	51
AF diagram	28
K7	193
AF Full Span	
softkey	43
AF Spectrum (analog demodulation)	21
AF Time Domain (analog demodulation)	21
AF trigger (K7)	16
All AF Filter Off	
softkey	34, 55, 201, 215
AM	
softkey	65
Amplitude menu	
analog demodulation	43
K7	206
analog demodulation	10
AF trigger (K7)	16
bandwidth (K7)	13
circuit description (K7)	11
measurement results (analog demodulation)	20
measurement time (analog demodulation)	13
sample rate (analog demodulation)	13
trigger offset (analog demodulation)	13
Analog Demodulation menu (K7)	10, 26
Application cards	6
Application notes	6
ASCII Trace export	23
attenuation	
(option B25)	47, 210
Attenuation	
(option B25)	47, 210
Automatic	47, 210
Manual	46, 177, 209
Option B25	46, 209
Auto level	
Hysteresis	50, 51
Auto Peak detector	19
Auto Set menu	49
Average detector	19
Average trace mode	18, 58

B

bandwidth	
resolution (analog demodulation)	51, 212
Bandwidth menu	
analog demodulation	51
K7S	211
Blank trace mode	19, 59
Brochures	6

C

Capture mode	57
--------------	----

Capture time	57
CCIR	
Softkey	32, 33, 54, 200, 214
CCIT	
Softkey	32, 53, 199, 213
Center frequency	40
Characters	
Special	83, 228
Clear Write trace mode	17, 58
Commands	
Description	82, 227
Continuous sweep	56
Coupled	
Result Summary Setup (K7S)	197, 201

D

Data sheets	6
Demod Filter	
Gaussian	55
softkey	55
Demodulation	
Offset	57
demodulation bandwidth (K7)	13
detector	
overview	19
Detector	
Auto Peak	60
Autoselect	59
Average	61
CISPR Average	61
K7S	197
Negative Peak	60
Positive Peak	60
Quasi Peak	61
RMS	60
RMS Average	61
Sample	60
Diff.Freq. Distortion	
remote control	230
softkey	221
Diff.Freq.Distortion (On/Off)	
softkey	222
DigIConf	
Softkey	79
Digital IQ data	
device	78
Digital IQ Info	
Remote control	178
Softkey	80
display configuration	
analog demodulation	20
K7	193
K7S	189
Display configuration	28
display range	
level	44, 45
Display range	
Frequency	40

E

Electronic input attenuation	
FSV-B25	181
EX-IQ-BOX	78
DiglConf	79
export format	23
External Mixer (B21)	
softkey	77
external noise source	76
external trigger	64, 216

F

Filters	
A Weighted	33, 54, 200, 214
fixed reference	72, 221
FM	
softkey	65
FM Stereo	188
FM Stereo menu (K7)	188
Frequency	
Center	40
Frequency menu	
analog demodulation	40
Full Scale Level	
Digital I/Q Interface (remote control)	179
Digital IQ	78

G

Getting started	5
-----------------------	---

H

Hysteresis	
Lower (Auto level)	51
Upper (Auto level)	50

I

IEC/IEEE bus	
Command description	82, 227
Impedance	
Input	49, 211
Input sample rate	
Digital IQ	78
Input/Output menu	76
Instrument security procedures	6
Intermod. Distortion	
softkey	223, 232
Intermod.Distortion (On/Off)	
softkey	224

K

key	
MEAS CONFIG (K7)	28

L

Left	
softkey	193, 217
level	
display range	44, 45
range	44, 45
Level	
Reference	44, 206

Level Unit

Digital I/Q Interface (remote control)	180
Digital IQ	78

line

threshold	75, 226
-----------------	---------

Lower Level Hysteresis

Softkey	51
---------------	----

Lower-case (commands)

M

Marker

Zoom	71
------------	----

Marker menu

analog demodulation	67
---------------------------	----

Marker Number

softkey	75, 226
---------------	---------

Marker Peak List

Activating/Deactivating	74, 225
Configuring	74, 225
Number display	75, 226
Number of entries	74, 225

Marker Wizard

softkey	68
---------------	----

Markers

Set to trace	68
--------------------	----

Max Hold trace mode

Max Peak Count

softkey	74, 225
---------------	---------

MEAS CONFIG key

K7	28
----------	----

Meas To Ref

Result Summary Setup (K7S)	197
----------------------------------	-----

menu

Amplitude (analog demodulation)	43
Amplitude (K7)	206
Analog Demodulation (K7)	10, 26
Auto Set (analog demodulation)	49
Bandwidth (analog demodulation)	51
Bandwidth (K7S)	211
FM Stereo (K7)	188
Frequency (analog demodulation)	40
Input/Output	76
Marker (analog demodulation)	67
Measurement (K7)	26
Span (analog demodulation)	42
Sweep (analog demodulation)	55
Trigger (analog demodulation)	63
Trigger (K7S)	215

Min Hold trace mode

Mode

Result Summary (K7S)	197
----------------------------	-----

Mono

softkey	205, 218
---------------	----------

More Traces

softkey	61
---------------	----

MPX

softkey	205, 217
---------------	----------

N

n dB down

marker function	73, 224
-----------------------	---------

Negative Peak detector

noise

source, external	76
------------------------	----

O

offset	
reference level	48, 211
Offset	
Trigger	219
Online help	
Working with	7
options	
Analog Demodulation (K7)	10
FM Stereo (K7)	188
Options	
FSV-B25	46, 181, 209
RF Preamplifier (B22)	46, 209
Overwrite mode	17, 58

P

Peak List On/Off	
softkey	74, 225
Ph. Noise Auto Peak Search	
remote control	173
Pilo	
softkey	205
Pilot	
softkey	218
PM	
softkey	65
polarity	
external trigger	66, 218
trigger edge	66, 218
Positive Peak detector	19
pre-trigger	66, 219
Preamplifier (B22)	46, 209
Probes	
Activating	77
Configuration (Softkey)	77

R

R&S Digital I/Q Interface (B17)	80, 178, 183
R&S Support	
softkey	79
RDS	
softkey	205, 218
reference	
fixed	72, 221
Reference Deviation	
K7S	196
reference level	
offset	48, 211
Reference level	44, 206
Reference Level	
Digital IQ	78
reference point	
frequency	73, 221
level	72, 221
peak search	73, 221
time	73, 221
Release notes	6
Repetition interval	
Time trigger	67, 219
resolution bandwidth	
analog demodulation	51, 212
Result Display	
analog demodulation	20
K7S	189

Result Summary Setup	
softkey	196
RF	
softkey	65, 218
RF diagram	28
K7	193
RF Power trigger	64, 216
RF Preamplifier (B22)	46, 209
RF Spectrum (analog demodulation)	21
RF Spectrum (K7)	190
RF Time Domain (analog demodulation)	21
RF Time Domain (K7S)	190
Right	
softkey	205, 217
RMS	
VBW	20
RMS detector	19
RX Settings	
softkey	79

S

Safety instructions	6
Sample detector	19
Sample rate	
Digital I/Q Interface (remote control)	180
Digital IQ	78
scaling	
level axis	48
SCPI	
Conformity information	82, 227
Search Signals	
remote control	233
softkey	223, 224
Security procedures	6
Service manual	5
Signal Source	
I/Q Analyzer	77
Remote control	182
Softkey	77
softkey	
= Center	41
0.1 * RBW (remote control)	154, 155
0.1 * Span (remote control)	154, 155
0.5 * RBW (remote control)	154, 155
0.5 * Span (remote control)	154, 155
A Weighted (remote control)	237
Abs Dev. Unit (K7S, remote control)	249, 250
AF Center (analog demodulation)	42
AF Center (remote control, analog demodulation)	121
AF Coupling AC/DC (K7)	35, 202, 207
AF Coupling AC/DC (remote control, analog demodulation)	122
AF Filter (K7s)	198
AF Full Span (analog demodulation)	43
AF Full Span (remote control, analog demodulation)	123
AF Range (K7s)	34, 201, 206
AF Span Manua (remote control, analog demodulation)	122
AF Span Manual (analog demodulation)	42
AF Start (analog demodulation)	42
AF Start (remote control, analog demodulation)	123
AF Stop (analog demodulation)	42
AF Stop (remote control, analog demodulation)	124
All AF Filter OFF (remote control, analog demodulation)	148, 235

All Marker Off	69
AM (K7)	28
AM/FM/PM/RF (remote control, analog demodulation)	90
ASCII File Export	75, 226
ASCII File Export (remote control)	183
ASCII Trace Export	63
Auto All	49
Average Mode (remote control)	158
CF Stepsize (remote control)	154
Cont Meas (remote control)	186
Continue Single Sweep (remote control)	185, 186
Continuous Sweep (remote control)	186
Decim Sep	63, 75, 226
Deemphasis (remote control, analog demodulation)	150, 151
Demod BW (analog demodulation)	30, 43, 52
Demod BW (remote control, analog demodulation) ..	147
Demod Filter	55
Demod Filter (remote control)	129, 148
Detector Auto Select (remote control)	159
Detector Manual Select (remote control)	159
Dev per Division (K7)	34, 201, 206
Deviation Lin/Log (K7)	35, 203, 208
Deviation Lin/Log (remote control)	114
Display Config (K7)	193
Display Config (remote control, analog demodulation)	90
Display Config (remote control)	109
EI Atten Mode (Auto/Man)	47, 210
External	64, 216
FM (K7)	37
Free Run	64, 216
Full Span (analog demodulation)	43
Full Span (remote control, K7)	142
Gate Delay (remote control)	156
Gate Mode Lvl/Edge (remote control)	156
Gated Trigger (remote control)	156
Grid Abs/Rel	48
Grid Abs/Rel (remote control)	112
High Pass AF Filter (analog demodulation) .	31, 52, 198, 212
High Pass AF Filter (remote control, analog demodulation)	151, 152
IF Output IF/Video (remote control)	184
IF Power	65, 217
Input 50 W/75 W (remote control)	182
Left Limit	74, 226
Left Limit (remote control)	106
Length Auto (K7)	36, 204
Length Auto (remote control, analog demodulation)	144, 145
Length Manual (K7)	36, 204
Length Manual (remote control, analog demodulation)	144, 145
Limits On/Off (remote control)	107
Lin	62
Link AF Spectrum Marker	71
Link AF Spectrum Marker (remote control)	96
Link Mkr1 and Delta1	71
Link Mrk1 and Delta1 (remote control)	173
Link Time Marker	71
Link Time Marker (remote control)	96
Low Pass AF Filter (remote control, analog demodulation)	152, 153, 241
Manual	41
Manual (remote control)	154
Marker 1 (remote control)	174
Marker 1 to 4 (remote control)	104, 105, 175
Marker 1-16	68
Marker 1, Marker 2 ...16	68
Marker 2 (remote control)	174
Marker 3 (remote control)	174
Marker 4 (remote control)	174
Marker Norm/Delta	68
Marker Norm/Delta (remote control)	174
Marker Stepsize	70
Marker Stepsize (remote control)	107
Marker Table (Off/On/Aut) (remote control)	109
Marker Table (On/Off)	70
Marker to Trace (remote control)	174
Marker Wizard	68
Marker Zoom (remote control)	95
Meas Time Auto	50
Meas Time Manual	50, 146
More Markers	68
n dB down	73, 224
n dB down (remote control)	100, 101, 102, 103
Noise Source	76
Noise Src On/Off (remote control)	185
Peak Excursion	74, 225
Peak Excursion (remote control)	104
Peak Search	73, 221
Peak Search (remote control)	98, 99, 100, 170
Ph Noise On/Off (remote control)	172
Ph Noise/Ref Fixed (remote control)	172
Phase Noise	72
Phase Noise (remote control, analog demodulation) ..	95
Phase Unit Rad/Deg (K7)	35, 46, 203, 208, 209
Phase Wrap On/Off (K7)	39
Phase Wrap On/Off (remote control, analog demodulation)	93
PM (K7)	38
Power	62
Power Sensor	76
R&S Support	79
Range Lin. Unit	46
Range Lin. Unit (remote control)	114
Range Linear %	45
Range Linear % (remote control)	114
Range Log (remote control)	111, 114
Range Log 1 dB	45
Range Log 5 dB	45
Range Log 10 dB	45
Range Log 50 dB	44
Range Log 100 dB	44
Range Log Manual	45
Ref Fixed	72, 221
Ref Level Offset	48, 211
Ref Level Offset (remote control)	113
Ref Level Position	48
Ref Level Position (remote control)	113
Ref Point Frequency	73, 221
Ref Point Frequency (remote control)	171
Ref Point Level	72, 221
Ref Point Level (remote control)	171
Ref Point Time (remote control)	171
Ref Value Position (remote control)	113
Reference Fixed On/Off	72, 221
Reference Position (K7)	34, 202, 207
Reference Position (remote control)	113
Reference Value (K7)	34, 202, 207
Reference Value (remote control, analog demodulation)	114

- Res BW (analog demodulation) 51, 212
 - Res BW (remote control, K7) 140
 - RF Power(K7) 39
 - Right Limit 75, 226
 - Right Limit (remote control) 106
 - Save Evaluation List (remote control) 183
 - Search Lim Off (remote control) 97, 107
 - Search Limits (remote control) 107
 - Select 1 2 3 4 (remote control) 104
 - Select Marker (No) 72, 220
 - Select Trace (K7) 30
 - Settings 50
 - Single Meas (remote control) 186
 - Single Sweep (remote control) 186
 - Sort Mode Freq/Lvl (remote control) 95, 99
 - Span Manual (analog demodulation) 42
 - Span Manual (remote control, K7) 142
 - Start (K7) 36, 204
 - Stepsize Standard 70
 - Stepsize Standard (remote control) 107
 - Stepsize Sweep Points 70
 - Stepsize Sweep Points (remote control) 107
 - Sweep Count 56
 - Sweep Points 57
 - Sweep Points (remote control) 157
 - THD Unit %/DB (K7) 35, 46, 203, 208, 209
 - THD Unit %/DB (remote control) 98, 170, 250
 - Threshold 75, 226
 - Threshold (remote control) 96, 97
 - Trace 1 2 3 4 5 6 (remote control) 111
 - Trace Mode (remote control) 112
 - Tracking Generator 76
 - Trg/Gate Level (remote control) 167
 - Trg/Gate Polarity Pos/Neg (remote control) 156, 167
 - Trg/Gate Source (remote control) 156, 166
 - Trigger Holdoff (remote control) 163
 - Trigger Offset (analog demodulation) 66
 - Trigger Out (Low/High)(remote control) 184
 - Trigger Polarity 66, 218
 - Trigger Source (analog demodulation) 64
 - Trigger Source (K7S) 216
 - Trigger Source (remote control, K7) 248
 - Unit (K7s) 35, 203, 208
 - Unit (remote control) 97, 169, 249
 - Unit %/DB (K7) 222, 224
 - Video Output 76
 - Weighting (remote control, analog demodulation) ... 149, 150
 - X * RBW (remote control) 154, 155
 - X * Span (remote control) 154, 155
 - Zero Phase Reference Point (K7) 38
 - Zero Phase Reference Point (remote control, K7) 137
 - Zoom (remote control, analog demodulation) ... 143, 144
- Softkey
- AF Filter (analog demodulation) 31, 52, 212
 - Auto Freq 50
 - Auto Level 50
 - Average 18, 58
 - Average Mode 61
 - BB Power Retrigger Holdoff (remote control) 163
 - Blank 19, 59
 - Center 40
 - Center (remote control) 153
 - Clear Write 17, 58
 - Cont Meas (remote control) 186
 - Continue Single Sweep 56
 - Continuous Sweep 56
 - Continuous Sweep (remote control) 186
 - Decim Sep (remote control) 185
 - Deemphasis (analog demodulation) 33, 54, 200, 214
 - DigiConf 79
 - Display Config 28
 - EL Atten Mode (Auto/Man) (remote control) 181
 - EI Atten On/Off 47, 210
 - EX-IQ-BOX 78
 - IF Power Retrigger Holdoff (remote control) 163
 - IF Power Retrigger Hysteresis (remote control) 164
 - Input (AC/DC) 48, 76, 211
 - Input (AC/DC)(remote control) 178
 - Input 50 Ω/75 Ω 49, 211
 - Log 62
 - Low Pass AF Filter (analog demodulation) .. 31, 52, 199, 213
 - Marker 1 to 4 (remote control) 107, 176
 - Marker Number 75, 226
 - Marker Number (remote control) 94
 - Marker Peak List 74, 225
 - Marker to Trace 68
 - Marker to Trace (remote control) 105
 - Marker Zoom 71
 - Max Hold 18, 58
 - Max Peak Count 74, 225
 - May Peak Size (remote control) 94
 - Meas Time (analog demodulation) . 31, 52, 56, 197, 212
 - Mech Atten Auto 47, 210
 - Mech Atten Auto (remote control) 177
 - Mech Atten Manual 46, 209
 - Mech Atten Manual (remote control) 177
 - Min Hold 18, 58
 - Peak List On/Off 74, 225
 - Preamp On/Off 46, 209
 - Preamp On/Off (remote control) 181
 - Ref Level 44, 206
 - Ref Level (remote control) 113
 - RF Atten Auto 47, 210
 - RF Atten Auto (remote control) 177
 - RF Atten Manual 46, 209
 - RF Atten Manual (remote control) 177
 - RF Power 64, 216
 - Save (remote control) 183
 - Select 1 2 3 4 (remote control) 107
 - Single Meas (remote control) 186
 - Single Sweep 56
 - Single Sweep (remote control) 186
 - Sort Mode Freq/Lvl 74, 225
 - Squelch 37, 204
 - Squelch (remote control) 142
 - Squelch Level 37, 204
 - State On / Off 36, 203
 - Sweep Count (remote control) 155
 - Time Domain Zoom (K7) 36, 203
 - Trace 1 57
 - Trace 2 57
 - Trace 3 57
 - Trace 4 57
 - Trace 5 57
 - Trace 6 57
 - Trace Mode (remote control) 110
 - Trg/Gate Source (remote control) 165, 167
 - Trigger Holdoff 67, 220
 - Trigger Hysteresis 67, 219
 - Trigger Offset 219
 - Trigger Out 77

- View 18, 59
- Weighting AF Filter 32, 53, 199, 213
- Softkeys
 - Autoselect 59
 - Detector Auto Peak 60
 - Detector Average 61
 - Detector CISPR Average 61
 - Detector Manual Select 59
 - Detector Negative Peak 60
 - Detector Positive Peak 60
 - Detector Quasi Peak 61
 - Detector RMS 60
 - Detector RMS Average 61
 - Detector Sample 60
 - Lower Level Hysteresis 51
 - Probe Config 77
 - Upper Level Hysteresis 50
- Span menu
 - analog demodulation 42
- Special characters 83, 228
- Squelch
 - Remote control 142
 - Softkey 37, 204
- Squelch Level
 - Softkey 37, 204
- Stereo
 - softkey 205, 218
- supply voltage, external noise source 76
- sweep
 - count 56
 - Free Run 64, 216
- Sweep
 - Continue single sweep 56
 - Continuous 56
 - Single 56
- Sweep menu
 - analog demodulation 55
- T**
- threshold
 - line 75, 226
- Time
 - softkey 66, 218
- Time per Division
 - softkey 204
- Time trigger
 - Repetition interval 67, 219
- Trace
 - Clear Write 17, 58
- Trace mode 57
 - Average 18, 58
 - Blank 19, 59
 - Clear Write 17, 58
 - Max Hold 18, 58
 - Min Hold 18, 58
 - View 18, 59
- trigger
 - external 64, 216
 - slope 66, 218
- Trigger
 - Holdoff 67, 220
 - Hysteresis 67, 219
 - Level 66, 218
 - Offset 219
- Trigger menu
 - analog demodulation 63
 - K7S 215
- trigger mode
 - External 64, 216
 - Free Run 64, 216
 - IF power 65, 217
- Trigger mode
 - RF power 64, 216
- TX Settings
 - EX-IQ-BOX 79
- U**
- Upper Level Hysteresis
 - Softkey 50
- Upper-case (commands) 83, 228
- V**
- VBW
 - RMS detector 20
- View trace mode 18, 59
- W**
- Weighting
 - Analog demodulation 32, 53, 199, 213
- White papers 6
- Z**
- Zoom 71
 - Amplitude 18, 59