

2015 6½-Digit THD Multimeter

2015-P 6½-Digit Audio Analyzing Multimeter

Datasheet



KEITHLEY
A Tektronix Company

The 2015-P Audio Analyzing Digital Multimeter and the 2015 Total Harmonic Distortion Multimeter combine audio band quality measurements and analysis with a full-function 6½-digit DMM. Test engineers can make a broad range of voltage, resistance, current, frequency, and distortion measurements, all with the same compact, half-rack measurement instrument. The 2015-P offers additional processing capacity for frequency spectrum analysis.

Key Features

- THD, THD+Noise, and SINAD measurements
- 20 Hz–20 kHz sine wave generator
- Fast frequency sweeps
- 2015-P identifies peak spectral components
- Sine wave generator maximum amplitude: 4 Vrms single-ended or 8 Vrms differential output
- Individual harmonic magnitude measurements
- 5 standard audio shaping filters
- 13 DMM functions (6½ digits)
- GPIB and RS-232 interfaces

Frequency Domain Distortion Analysis

For applications such as assessing non-linear distortion in components, devices, and systems, DSP-based processing allows the 2015 and 2015-P to provide frequency domain analysis in conventional time domain instruments. They can measure Total Harmonic Distortion (THD) over the complete 20 Hz to 20 kHz audio band. They also measure over a wide input range (up to 750 Vrms) and have low residual distortion (–87 dB). The THD reading can be expressed either in decibels or as a percentage.

In addition to THD, the 2015 and 2015-P can compute THD+Noise and Signal-to-Noise plus Distortion (SINAD). For analyses in which the individual harmonics are the criteria of greatest interest, the instruments can report any of the (up to 64) harmonic magnitudes that can be included in the distortion measurements. The user can program the actual number of harmonics to be included in a computation, so accuracy, speed, and complexity can be optimized for a specific application. (See **Figure 1**.)

Optimized for Production Testing

The 2015 and 2015-P can perform fast frequency sweeps for characterizing audio-band circuitry in production test systems. For example, the instruments can execute a single sweep of 30 frequencies and transmit both rms voltage readings and THD readings to a computer in only 1.1 seconds. With that data, a complete frequency response analysis and a harmonic distortion vs. frequency analysis can be performed in a very short time. Thus high speed testing of the audio performance of a high volume device such as a cellular telephone can be performed without reducing the number of tests or reducing the measurements in each test. With these instruments, which are optimized for production testing, test engineers can lower test times, in comparison to test speeds achievable with general purpose audio analyzers, without sacrificing production test quality.

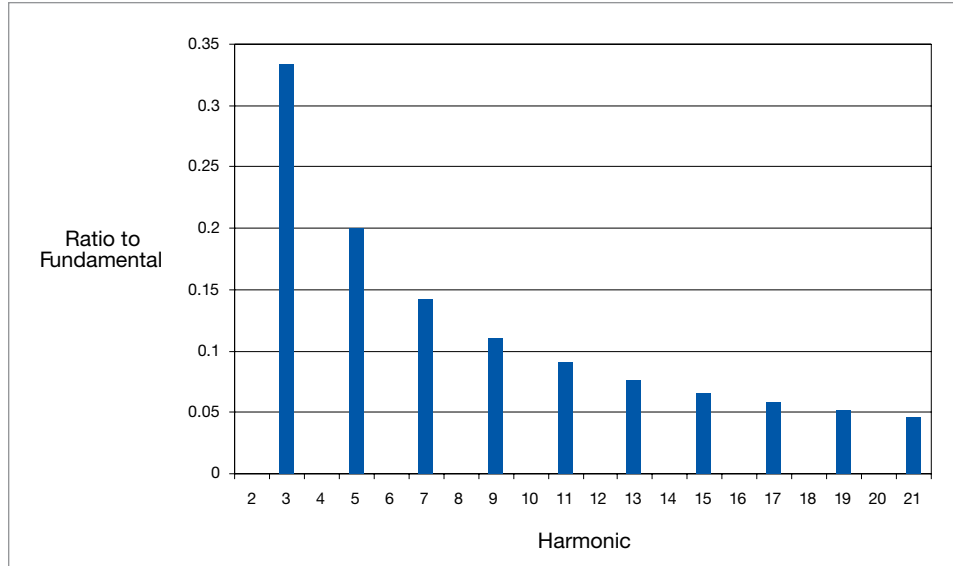

Figure 1. Frequency Spectrum of 1kHz Square Wave. Figure 1 shows a plot of a square wave’s harmonics (frequency components) computed and transmitted to a personal computer by the 2015. A square wave’s spectral content consists of only odd harmonics whose magnitudes are $(1/\text{harmonic number} \times \text{the magnitude of the fundamental})$. For example, the magnitude of the third harmonic is $1/3$ the magnitude of the fundamental.

Figures 2, 3, and 4 demonstrate how the 2015 and 2015-P can provide both time domain and frequency domain measurements in a single test protocol.

Figure 2 shows a sample test system schematic with a telecommunication device in a loop back mode test. The Audio Analyzing DMM’s source provides a stimulus frequency sweep, and the Audio Analyzing DMM measures the response from the microphone circuit.

Figure 3 shows the resulting frequency domain analysis of the THD and the first three harmonics as a function of frequency. Figure 4 shows the time domain analysis of microphone circuit output voltage as a function of frequency.

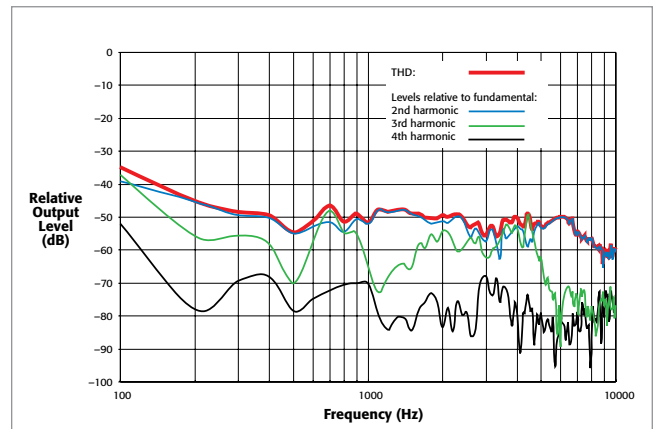

Figure 3. THD and 2nd, 3rd, and 4th Harmonics as a Function of Frequency

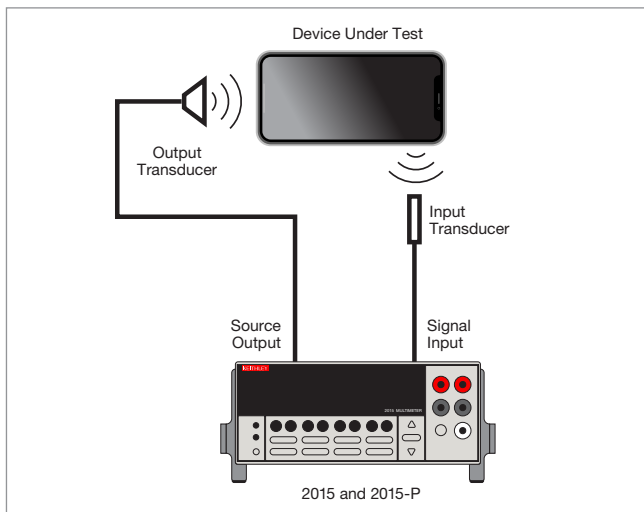

Figure 2. Total Harmonic Distortion Analysis and Frequency Response of a Portable Wireless Telecommunication Device

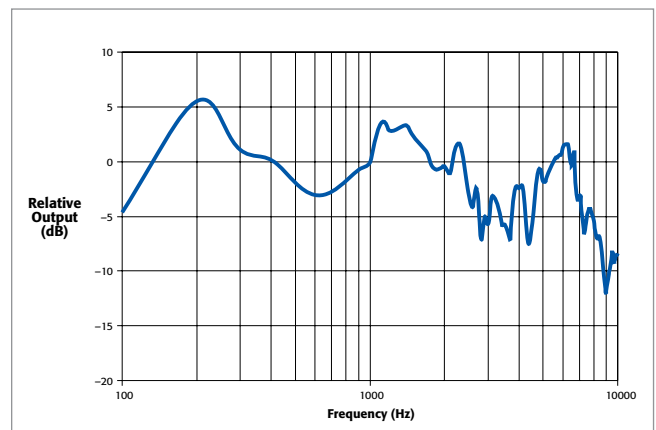

Figure 4. Frequency Response

Dual Output Source

The 2015 and 2015-P include an internal audio band sine wave source for generating stimulus signals. A second output, the inverse of the first output, is also available, simplifying the testing of differential input circuits for common mode or noise cancellation performance. The 2015 and 2015-P have a 4 Vrms single-ended output and 8 Vrms differential source output.

Wide Selection of Audio Filters

Five industry-standard bandpass filters are provided for shaping the input signal for audio and telecommunication applications. Available filters include the CCITT weighting filter, CCIR filter, C-message filter, CCIR/ARM filter, and “A” weighting filter (see **Figures 5a–5e**). The 2015 and 2015-P provide programmable, high cutoff (low pass) and low cutoff (high pass) filters. Furthermore, the two filters can be implemented together to form a bandpass filter. The programmable filters can be used to filter out noise generated by electromechanical machinery on the production floor or to simulate other types of system transmission characteristics.

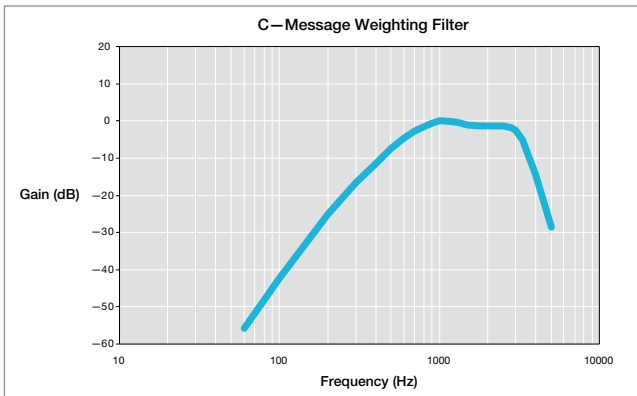

Figure 5a.

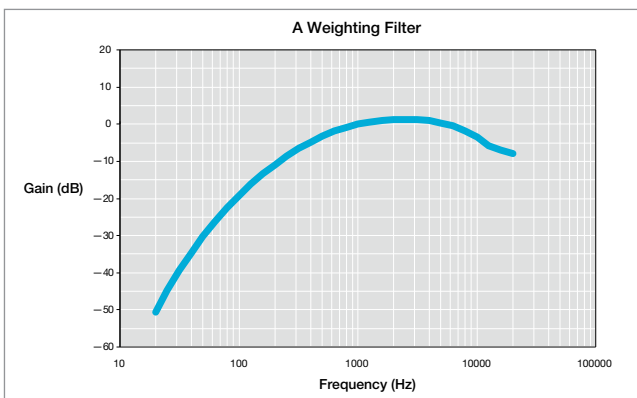

Figure 5b.

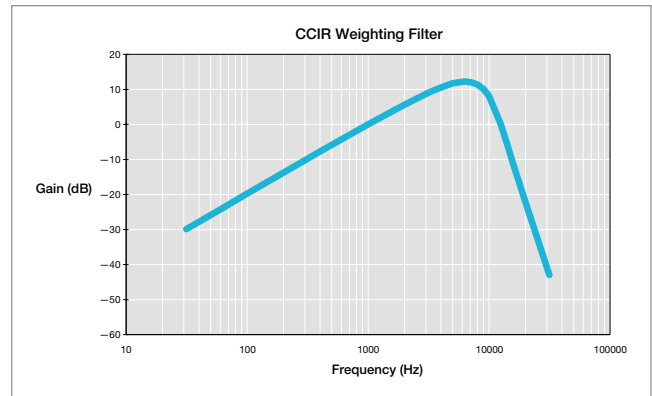

Figure 5c.

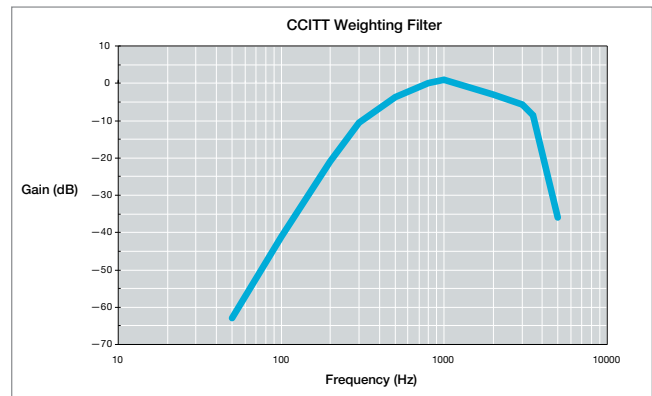

Figure 5d.

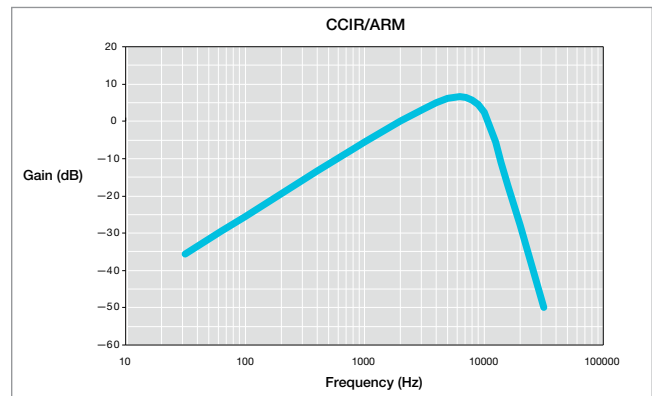

Figure 5e.

Broad Measurement Flexibility

In addition to their THD, THD+Noise, SINAD, and individual harmonic measurement capabilities, the instruments provide a comprehensive set of DMM functions, including DCV, ACV, DCI, ACI, 2WΩ, 4WΩ, temperature, frequency, period, dB, dBm, and continuity measurements, as well as diode testing. This multi-functional design minimizes added equipment costs when configuring test setups.

Wide Band or Narrow Band Noise Measurements

The 2015 and 2015-P are capable of measuring both wide band noise and narrow band noise. Alternatively, these instruments' DSP (digital signal processing) capabilities allow users to make frequency domain measurements of RMS voltage noise over the 20 Hz–20 kHz frequency audio band or a narrow portion of the band. Furthermore, noise measurements can be extracted in the presence of a stimulus signal for fast signal-to-noise computations.

Spectrum Analysis

The 2015-P has internal computational capabilities that allow it to characterize an acquired signal spectrum. This instrument can identify and report the frequency and amplitude of the highest value in a complete spectrum or within a specified frequency band. It can also identify additional peaks in descending order of magnitude (see **Figure 6**). The 2015-P's on-board capabilities make it simple to obtain a thorough analysis of a frequency spectrum more quickly and with little or no need for external analysis software.

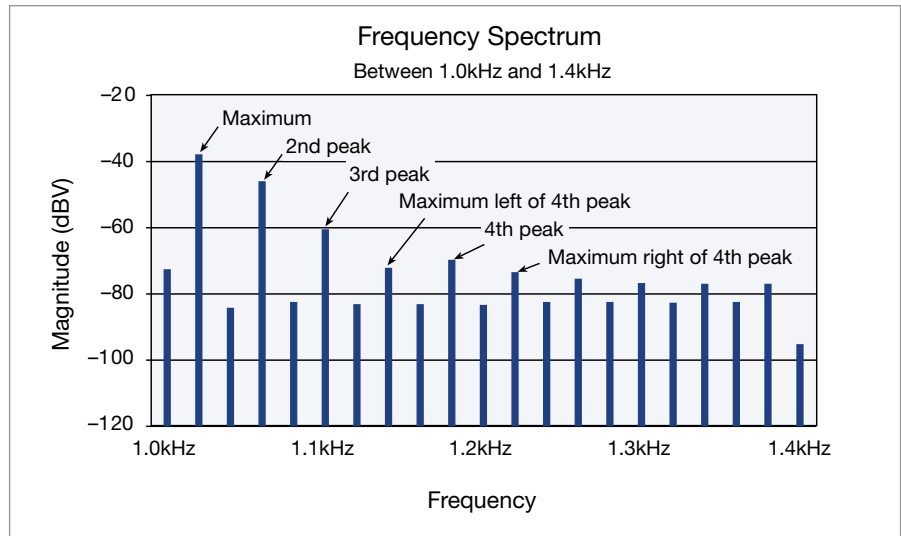

Figure 6. The 2015-P directly identifies peak values of the frequency spectrum.

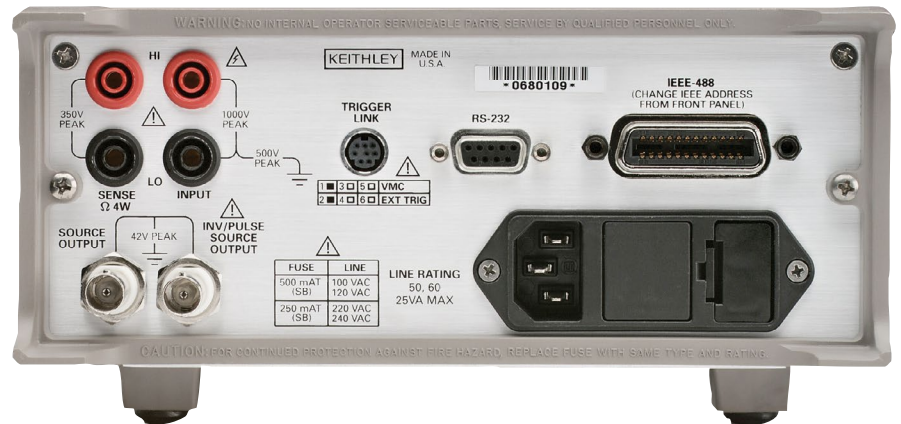

Figure 7. Rear panel of both models

Typical Applications

- Wireless communication device audio quality testing
- Component linearity testing
- Lighting and ballast THD limit conformance testing
- Telephone and automotive speaker testing

Specifications

Distortion Characteristics

Voltage Range	100 mV, 1 V, 10 V, 100 V, 750 V (user selectable).
Input Impedance	1 MΩ paralleled by <100 pF.
Display Range	0–100% or 0–100.00 dB.
Resolution	0.0001% or 0.00001 dB.
Fundamental Frequency Range	20 Hz–20 kHz.
Harmonic Frequency Range	40 Hz–50 kHz.
Frequency Resolution	0.008 Hz.
Frequency Accuracy	±0.01% of reading.
Frequency Temperature Coefficient	≤100 ppm over operating temperature range.

Measurement Mode	Accuracy (1 Year, 23°C ±5°C)	Residual Distortion ¹
THD and individual harmonic magnitudes	±0.8 dB 20 Hz to 20 kHz ²	0.004% or –87 dB 20 Hz to 20 kHz
THD + n	±1.5 dB 100 Hz to 20 kHz ²	0.056% or –65 dB 20 Hz to 20 kHz
SINAD	±1.5 dB 100 Hz to 20 kHz ²	+65 dB 20 Hz to 20 kHz
AC Level V rms	±(0.15% of reading + 0.009% of range) 20 Hz to 20 kHz	

Distortion Measurement Audio Filters

None	C-Message
CCITT Weighting	CCIR/ARM
CCIR	“A” Weighting

Number of Harmonics Included in THD Calculation
2 to 64 (user selectable).

HI and LO Cutoff Filters (bus settable)
20 Hz–50 kHz. Can be combined to form brickwall bandpass filter.

Distortion Measurement Reading Rate³

Fundamental Frequency Acquisition Mode	Fundamental Frequency Range	Minimum Readings Per Second
Single acquisition or stored value	20 Hz to 100 Hz	14
	100 Hz to 1 kHz	24
	1 kHz to 20 kHz	28
Automatic	20 Hz to 30 Hz	5.5
	30 Hz to 400 Hz	6
	400 Hz to 20 kHz	6.6

Frequency Sweep Reading Rate

Number of Frequencies	Time (seconds) ⁴
5	0.2
30	1.1
100	3.5
200	6.9

Notes

- Input signal at full scale.
- $V_{IN} \geq 20\%$ of range and harmonics > –65 dB.
- Speeds are for default operating conditions (*RST), and display off, auto range off, binary data transfer, trig delay = 0.
- Typical times: frequencies in 400–4 kHz range, binary data transfer, TRIG DELAY = 0, Display OFF, Auto Range OFF. Data returned is THD measurement plus AC voltage.

Generator Characteristics

Frequency Range	10–20 kHz.
Frequency Resolution	0.007 Hz.
Frequency Accuracy	$\pm(0.015\%$ of reading + 0.007 Hz) ¹ .
Frequency Temperature Coefficient	<100 ppm over operating temperature range.

Source Output

Waveform	Sinewave.
Amplitude Range	2 V rms (50 Ω and 600 Ω) or 4 V rms (HI Z).
Amplitude Resolution	0.5 mV rms (50 Ω and 600 Ω) or 1 mV rms (HI Z).
Amplitude Accuracy	$\pm(0.3\%$ of setting + 2.5 mV) ^{1, 4} .
Amplitude Temperature Coefficient	Typically 0.015%/°C.
Amplitude Flatness	± 0.1 dB ^{1, 4, 5} .
Output Impedance	50 $\Omega \pm 1 \Omega$ or 600 $\Omega \pm 10 \Omega$, user selectable.
THD	–64 dB ⁶ .
Noise	100 μ V rms ² .
DC Offset Voltage	± 2.5 mV ¹ .

Inv/Pulse Output (Sinewave Mode)

Frequency	Same as source output.
Amplitude Range	2 V rms (50 Ω and 600 Ω) or 4 V rms (HI Z).
Amplitude Resolution	0.5 mV (50 Ω and 600 Ω) or 1 mV rms (HI Z).
Amplitude Accuracy	$\pm(2.0\%$ of setting + 2.5 mV) ^{1, 4} .
Amplitude Flatness	± 0.1 dB ^{1, 4, 5} .
Output Impedance	Same as Source Output setting.
THD	–64 dB ⁶ .
Noise	100 μ V rms ² .
DC Offset Voltage	± 1.1 mV typ., ± 13 mV max. ¹

Inv/Pulse Output (Pulse Mode)

Frequency	Same as source output.
Duty Cycle	45% $\pm 3\%$.
Output Impedance	Same output impedance as the source output.
Amplitude	0.0 V ± 0.07 V to 4.9 V ± 0.12 V pulse open circuit ^{1, 3} . 0.0 V ± 0.05 V to 3.3 V ± 0.11 V pulse open circuit ^{1, 3} .
Overshoot	1.0 V maximum pulse open circuit ³ . 0.2 V maximum with 100 Ω load pulse open circuit ³ .
Undershoot	1.1 V maximum pulse open circuit ³ . 0.45 V maximum with 100 Ω load pulse open circuit ³ .

Notes

- 1 year, 23°C $\pm 5^\circ$ C.
2. Measured at $V_{OUT} = 0$ V with gain 100 amplifier and 2-pole 50 kHz low pass filter, Inv/Pulse in sinewave mode, HI Z output impedance, and no load.
3. With HI Z output impedance and 1m 50 Ω coaxial cable.
4. HI Z output impedance, no load.
5. 4 V output.
6. THD measurement includes harmonics 2 through 5, 1 V rms output, HI Z, no load.

DC Characteristics

Conditions MED (1 PLC) ¹ or SLOW (10 PLC) or MED (1 PLC) with filter of 10.

Function	Range	Resolution	Test Current or Burden Voltage (±5%)	Input Resistance	Accuracy ±(ppm of reading + ppm of range) (ppm = parts per million) (e.g., 10 ppm = 0.001%)			Temperature Coefficient 0°–18°C & 28°–50°C
					24 Hour ¹⁴ 23°C ± 1°	90 Day 23°C ± 5°	1 Year 23°C ± 5°	
Voltage	100.0000 mV ¹⁷	0.1 µV		> 10 GΩ	30 + 30	40 + 35	50 + 35	2 + 6
	1.000000 V	1.0 µV		> 10 GΩ	15 + 6	25 + 7	30 + 7	2 + 1
	10.00000 V	10 µV		> 10 GΩ	15 + 4	20 + 5	30 + 5	2 + 1
	100.0000 V	100 µV		10 MΩ ±1%	15 + 6	30 + 6	45 + 6	5 + 1
	1000.000 V ⁹	1 mV		10 MΩ ±1%	20 + 6	35 + 6	45 + 6	5 + 1
Resistance ¹⁵	100.0000 Ω	100 µΩ	1 mA		30 + 30	80 + 40	100 + 40	8 + 6
	1.000000 kΩ	1 mΩ	1 mA		20 + 6	80 + 10	100 + 10	8 + 1
	10.00000 kΩ	10 mΩ	100 µA		20 + 6	80 + 10	100 + 10	8 + 1
	100.0000 kΩ	100 mΩ	10 µA		20 + 6	80 + 10	100 + 10	8 + 1
	1.000000 MΩ ¹⁶	1 Ω	10 µA		20 + 6	80 + 10	100 + 10	8 + 1
	10.00000 MΩ ^{11, 16}	10 Ω	700 nA // 10MΩ		300 + 6	450 + 10	600 + 10	95 + 1
	100.0000 MΩ ^{11, 16}	100 Ω	700 nA // 10MΩ		1600 + 30	2000 + 30	2200 + 30	900 + 1
Current	10.00000 mA	10 nA	< 0.15 V		60 + 30	300 + 80	500 + 80	50 + 5
	100.0000 mA	100 nA	< 0.03 V		100 + 300	300 + 800	500 + 800	50 + 50
	1.000000 A	1 µA	< 0.3 V		200 + 30	500 + 80	800 + 80	50 + 5
	3.00000 A	10 µA	< 1 V		1000 + 15	1200 + 40	1200 + 40	50 + 5
Continuity 2W	1 kΩ	100 mΩ	1 mA		40 + 100	100 + 100	120 + 100	8 + 1
Diode Test	3.00000 V	10 µV	1 mA		20 + 6	30 + 7	40 + 7	8 + 1
	10.00000 V	10 µV	100 µA		20 + 6	30 + 7	40 + 7	8 + 1
	10.00000 V	10 µV	10 µA		20 + 6	30 + 7	40 + 7	8 + 1

DC Operating Characteristics²

Function	Digits	Readings/s	PLCs ⁸
DCV (all ranges), DCI (all ranges), 2W Ohms (<10 M ranges)	6.5 ^{3, 4}	5	10
	6.5 ^{3, 7}	30	1
	6.5 ^{3, 5}	50	1
	5.5 ^{3, 5}	270	0.1
	5.5 ⁵	500	0.1
	5.5 ⁵	1000	0.04
	4.5 ⁵	2000	0.01

DC System Speeds^{2, 6}

Range Change ³	50/s.
Function Change ³	45/s.
Autorange Time ^{3, 10}	<30 ms.
ASCII readings to RS-232 (19.2k baud)	55/s.
Max. Internal Trigger Rate	2000/s.
Max. External Trigger Rate	400/s.

DC General

Linearity of 10 VDC Range	$\pm(1 \text{ ppm of reading} + 2 \text{ ppm of range})$.
DCV, Ω , Temperature, Continuity, Diode Test Input Protection	1000 V, all ranges.
Maximum 4W Ω Lead Resistance	10% of range per lead for 100 Ω and 1 k Ω ranges; 1 k Ω per lead for all other ranges.
DC Current Input Protection	3 A, 250 V fuse.
Shunt Resistor	0.1 Ω for 3 A, 1 A, and 100 mA ranges. 10 Ω for 10 mA range.
Continuity Threshold	Adjustable 1 Ω to 1000 Ω .
Autozero Off Error	Add $\pm(2 \text{ ppm of range error} + 5 \text{ } \mu\text{V})$ for <10 minutes and $\pm 1^\circ\text{C}$ change.
Overrange	120% of range except on 1000 V, 3 A, and Diode.

Speed and Noise Rejection

Rate	Readings/s	Digits	RMS Noise 10 V Range	NMRR ¹²	CMRR ¹³
10 PLC	5	6.5	< 1.5 μV	60 dB	140 dB
1 PLC	50	6.5	< 4 μV	60 dB	140 dB
0.1 PLC	500	5.5	< 22 μV	—	80 dB
0.01 PLC	2000	4.5	< 150 μV	—	80 dB

DC Notes

- Add the following to ppm of range accuracy specification based on range: 1 V and 100 V, 2 ppm; 100 mV, 15 ppm; 100 Ω , 15 ppm; 1 k Ω –1 M Ω , 2 ppm; 10 mA and 1 A, 10 ppm; 100 mA, 40 ppm.
- Speeds are for 60 Hz operation using factory default operating conditions (*RST). Autorange off, Display off, Trigger delay = 0.
- Speeds include measurement and binary data transfer out the GPIB.
- Auto zero off.
- Sample count = 1024, auto zero off.
- Auto zero off, NPLC = 0.01.
- Ohms = 24 readings/second.
- 1 PLC = 16.67 ms @ 60 Hz, 20 ms @ 50 Hz/400 Hz. The frequency is automatically determined at power up.
- For signal levels >500 V, add 0.02 ppm/V uncertainty for the portion exceeding 500 V.
- Add 120 ms for ohms.
- Must have 10% matching of lead resistance in Input HI and LO.
- For line frequency $\pm 0.1\%$.
- For 1 k Ω unbalance in LO lead.
- Relative to calibration accuracy.
- Specifications are for 4-wire ohms. For 2-wire ohms, add 1 Ω additional uncertainty.
- For rear inputs. Add the following to Temperature Coefficient "ppm of reading" uncertainty: 10 M Ω 70 ppm, 100 M Ω 385 ppm. Operating environment specified for 0° to 50°C, 50% RH at 35°C.
- When properly zeroed.

True RMS AC Voltage and Current Characteristics

Voltage Range	Resolution	Calibration Cycle	Accuracy ¹ $\pm(\% \text{ of reading} + \% \text{ of range})$, 23°C $\pm 5^\circ\text{C}$				
			3 Hz–10 Hz ¹⁰	10 Hz–20 kHz	20 kHz–50 kHz	50 kHz–100 kHz	100 kHz–300 kHz
100.0000 mV	0.1 μV						
1.000000 V	1.0 μV	90 Days	0.35 + 0.03	0.05 + 0.03	0.11 + 0.05	0.60 + 0.08	4 + 0.5
10.00000 V	10 μV						
100.0000 V	100 μV	1 Year	0.35 + 0.03	0.06 + 0.03	0.12 + 0.05	0.60 + 0.08	4 + 0.5
750.000 V	1 mV						
		Temperature Coefficient/ $^\circ\text{C}$ ⁸	0.035 + 0.003	0.005 + 0.003	0.006 + 0.005	0.01 + 0.006	0.03 + 0.01
Current Range	Resolution	Calibration Cycle	3 Hz–10 Hz	10 Hz–3 kHz	3 kHz–5 kHz		
1.000000 A	1 μA	90 Day/1 Year	0.30 + 0.04	0.10 + 0.04	0.14 + 0.04		
3.00000 A ⁹	10 μA	90 Day/1 Year	0.35 + 0.06	0.15 + 0.06	0.18 + 0.06		
		Temperature Coefficient/ $^\circ\text{C}$ ⁸	0.035 + 0.006	0.015 + 0.006	0.015 + 0.006		

High Crest Factor Additional Error ±(% of reading)⁷

Crest Factor	1–2	2–3	3–4	4–5
Additional Error	0.05	0.15	0.30	0.40

AC Operating Characteristics²

Function	Digits	Readings/s	Rate	Bandwidth
ACV (all ranges) and ACI (all ranges)	6.5 ³	2 s/reading	SLOW	3 Hz–300 kHz
	6.5 ³	1.4	MED	30 Hz–300 kHz
	6.5 ⁴	4.8	MED	30 Hz–300 kHz
	6.5 ³	2.2	FAST	300 Hz–300 kHz
	6.5 ⁴	35	FAST	300 Hz–300 kHz

Additional Low Frequency Errors ±(% of reading)

	Slow	Med	Fast
20 Hz – 30 Hz	0	0.3	–
30 Hz – 50 Hz	0	0	–
50 Hz – 100 Hz	0	0	1.0
100 Hz – 200 Hz	0	0	0.18
200 Hz – 300 Hz	0	0	0.10
> 300 Hz	0	0	0

AC System Speeds^{2, 5}

Function/Range Change ⁶	4/s.
Autorange Time	<3 s.
ASCII Readings to RS-232 (19.2k baud) ⁴	50/s.
Max. Internal Trigger Rate ⁴	300/s.
Max. External Trigger Rate ⁴	260/s.

AC General

Input Impedance	1 MΩ ±2% paralleled by <100 pF.
ACV Input Protection	1000 V _p .
Maximum DCV	400 V on any ACV range.
ACI Input Protection	3 A, 250 V fuse.
Burden Voltage	1 A Range: <0.3 V rms. 3 A Range: <1 V rms.
Shunt Resistor	0.1 Ω on all ACI ranges.
AC CMRR	>70 dB with 1 kΩ in LO lead.
Maximum Crest Factor	5 at full scale.
Volt Hertz Product	≤8 × 10 ⁷ V·Hz.
Overrange	120% of range except on 750 V and 3 A ranges.

AC Notes

- Specifications are for SLOW rate and sinewave inputs >5% of range.
- Speeds are for 60 Hz operation using factory default operating conditions (*RST). Auto zero off, Auto range off, Display off, includes measurement and binary data transfer out the GPIB.
- 0.01% of step settling error. Trigger delay = 400 ms.
- Trigger delay = 0.
- DETECTOR: BANDwidth 300, NPLC = 0.01.
- Maximum useful limit with trigger delay = 175 ms.
- Applies to non-sinewaves >5 Hz and <500 Hz. (Guaranteed by design for crest factors >4.3.)
- Applies to 0°–18°C and 28°–50°C.
- For signal levels >2.2 A, add additional 0.4% to “of reading” uncertainty.
- Typical uncertainties. Typical is defined as follows: Two sigma, 95% of all instruments are expected to measure <0.35% of reading; three sigma, 99.7% of all instruments are expected to measure <1.06% of reading.

Triggering and Memory

Reading Hold Sensitivity	0.01%, 0.1%, 1%, or 10% of reading.
Trigger Delay	0 to 99 hours (1 ms step size).
External Trigger Latency	200 μ s + <300 μ s jitter with autozero off, trigger delay = 0.
Memory	1024 readings.

Math Functions

Math Functions	Rel, Min/Max/Average/StdDev (of stored reading), dB, dBm, Limit Test, %, and mX+b with user defined units displayed.
dBm Reference Resistances	1 to 9999 Ω in 1 Ω increments.

Standard Programming Languages

SCPI (Standard Commands for Programmable Instruments).

Remote Interface

Remote Interface	GPIO (IEEE-488.1, IEEE-488.2) and RS-232C.
------------------	--

Frequency and Period Characteristics ^{1, 2}

ACV Range	Frequency Range	Period Range	Gate Time	Resolution \pm (ppm of reading)	Accuracy 90 Day/1 Year \pm (% of reading)
100 mV to 750 V	3 Hz to 500 kHz	333 ms to 2 μ s	1 s (SLOW)	0.333	0.01
			0.1 s (MED)	3.33	0.01
			10 ms (FAST)	33.3	0.01

Frequency Notes

- Specifications are for square wave inputs only. Input signal must be >10% of ACV range. If input is <20 mV on the 100 mV range, then the frequency must be >10 Hz.
- 20% overrange on all ranges except 750V range.

Temperature Characteristics

Thermocouple ^{2, 3, 4}			Accuracy ¹ 90 Day/1 Year (23°C \pm 5°C) Relative to Reference Junction
Type	Range	Resolution	
J	-200 to + 760°C	0.001°C	\pm 0.5°C
K	-200 to + 1372°C	0.001°C	\pm 0.5°C
T	-200 to + 400°C	0.001°C	\pm 0.5°C

Temperature Notes

- For temperatures <-100°C add \pm 0.1°C and >900°C add \pm 0.3°C.
- Temperature can be displayed in °C, K, or °F.
- Accuracy based on ITS-90.
- Exclusive of thermocouple error.

General

Power Supply	100 V / 120 V / 220 V / 240 V.
Line Frequency	50 Hz to 60 Hz and 400 Hz, automatically sensed at power-up.
Power Consumption	40 VA.
Volt Hertz Product	$\leq 8 \times 10^7$ V·Hz.
Safety	Conforms to European Union Low Voltage Directive.
EMC	Conforms to European Union EMC Directive.
Vibration	MIL-PRF-28800F Class 3 Random.
Warmup	1 hour to rated accuracy.
Operating Environment	Specified for 0°C to 50°C. Specified to 80% R.H. at 35°C and at an altitude of up to 2,000 meters.
Storage Environment	-40°C to 70°C.
Dimensions:	
Rack Mounting	89 mm high × 213 mm wide × 370 mm deep (3.5 in × 8.38 in × 14.56 in).
Bench Configuration (with handle and feet)	104 mm high × 238 mm wide × 370 mm deep (4.13 in × 9.38 in × 14.56 in).
Net Weight	4.2 kg (8.8 lbs).
Shipping Weight	5 kg (11 lbs).
Warranty	1 year.

Ordering Information

2015	Total Harmonic Distortion 6½-Digit Multimeter
2015-P	Audio Analyzing DMM

Supplied Accessories

1751	Safety Test Leads
	Quick Start Guide
	Certificate of Calibration

Available Accessories

Cables/Adapters

7007-1	Shielded IEEE-488 Cable, 1 m (3.3 ft)
7007-2	Shielded IEEE-488 Cable, 2 m (6.6 ft)
8501-1, 8501-2	Trigger-Link Cables, 1 m (3.3 ft), 2 m (6.6 ft)
8502	Trigger Link Adapter Box
8503	Trigger Link Cable to 2 male BNCs, 1 m (3.3 ft)
7009-5	RS-232 Cable

Rack Mount Kits

4288-1	Single Fixed Rack Mount Kit
4288-2	Dual Fixed Rack Mount Kit

GPIB Interfaces

KPCI-488LPA	IEEE-488 Interface/Controller for the PCI Bus
KUSB-488B	IEEE-488 USB-to-GPIB Interface Adapter

Power Cord Options

A0	North America Power Plug (120 V, 60 Hz)
A1	Universal Euro Power Plug (220 V, 50 Hz)
A2	United Kingdom Power Plug (240 V, 50 Hz)
A3	Australia Power Plug (240 V, 50 Hz)
A4	Chile, Italy (220 V, 50 Hz)
A5	Switzerland Power Plug (220 V, 50 Hz)
A6	Japan Power Plug (100 V, 50/60 Hz)
A7	Denmark Power Plug
A8	Israel Power Plug
A9	Argentina Power Plug
A10	China Power Plug (50 Hz)
A11	India Power Plug (50 Hz)
A12	Brazil Power Plug (60 Hz)
A99	No power cord

Documentation

Instruction Manuals (available at www.tek.com/tektronix-and-keithley-digital-multimeter/keithley-2015-series-thd-and-audio-analysis-multimeter)

2015/2015-P THD Multimeter User's Manual

2015, 2015-P THD Multimeters Quick Reference Guide

Available Services

Extended Warranties

2015-EW	1-Year KEITHLEYCARE Extended Warranty
2015-3Y-EW	3-Year KEITHLEYCARE Extended Warranty
2015-5YR-EW	5-Year KEITHLEYCARE Extended Warranty
2015-P-EW	1-Year KEITHLEYCARE Extended Warranty
2015-P-3Y-EW	3-Year KEITHLEYCARE Extended Warranty
2015-P-5YR-EW	5-Year KEITHLEYCARE Extended Warranty

Calibration Contracts

C/2015-3Y-STD	KEITHLEYCARE 3-Year Standard Calibration Plan
C/2015-3Y-DATA	KEITHLEYCARE 3-Year Calibration with Data Plan
C/2015-3Y-17025	KEITHLEYCARE 3-Year ISO 17025 Calibration Plan
C/2015-5Y-STD	KEITHLEYCARE 5-Year Standard Calibration Plan
C/2015-5Y-DATA	KEITHLEYCARE 5-Year Calibration with Data Plan
C/2015-5Y-17025	KEITHLEYCARE 5-Year ISO 17025 Calibration Plan

Calibration Data

C/NEW DATA	Calibration Data for New 2015 or 2015-P
C/NEW DATA ISO	ISO-17025 Calibration Data for New 2015 or 2015-P
C/TRACE CHART	Calibration Traceability Chart